



University of Maribor Press

FACULTY OF MECHANICAL ENGINEERING  
RESEARCH GUIDE

FS

MARIBOR  
APRIL 2025





University of Maribor

---

Faculty of Mechanical Engineering

# FACULTY OF MECHANICAL ENGINEERING RESEARCH GUIDE



Editors  
**Lidija Fras Zemljič**  
**Tatjana Kreže**  
**Mateja Novak**

MARIBOR  
APRIL 2025

- Title** Faculty of Mechanical Engineering
- Subtitle** Research Guide
- Editors** Lidija Fras Zemljič  
(University of Maribor, Faculty of Mechanical Engineering)
- Tatjana Kreže  
(University of Maribor, Faculty of Mechanical Engineering)
- Mateja Novak  
(University of Maribor, Faculty of Mechanical Engineering)
- Translation** Shelagh Margaret Hedges
- Technical editors** Tatjana Kreže  
(University of Maribor, Faculty of Mechanical Engineering)
- Jan Perša  
(University of Maribor, Faculty of Mechanical Engineering)
- Cover designer** Tatjana Kreže  
(University of Maribor, Faculty of Mechanical Engineering)
- Cover graphics** (University of Maribor, Faculty of Mechanical Engineering, 2024)
- Graphic material** Sources are own unless otherwise noted  
Fras Zemljič, Kreže, Novak (editors), 2025
- Published by** University of Maribor  
University Press  
Slomškov trg 15, 2000 Maribor, Slovenia  
<https://press.um.si>, [zalozba@um.si](mailto:zalozba@um.si)
- Issued by** University of Maribor  
Faculty of Mechanical Engineering  
Smetanova ulica 17, 2000 Maribor, Slovenia  
<https://www.fs.um.si>, [fs@um.si](mailto:fs@um.si)
- Edition** 1<sup>st</sup>, translation of the original work from the Slovenian language Fras Zemljič, L., Kreže, T., Novak, M. (ur.). (2024). *Fakulteta za strojništvo: Raziskovalni vodnik*. Univerza v Mariboru, Univerzitetna založba doi: 10.18690/um.fs.6.2024
- Publication type** E-book
- Published at** Maribor, Slovenia, April 2025
- Available at** <https://press.um.si/index.php/ump/catalog/book/956>

CIP - Kataložni zapis o publikaciji  
Univerzitetna knjižnica Maribor

378.6(497.4Maribor):001.891(036)(0.034.2)

FACULTY of Mechanical Engineering [Elektronski vir] : research guide  
: FS / editors Lidija Fras Zemljič, Tatjana Kreže, Mateja Novak ;  
[translation Shelagh Margaret Hedges]. - 1st ed. - E-knjiga. - Maribor :  
University of Maribor, University Press, 2025

Način dostopa (URL): <https://press.um.si/index.php/ump/catalog/book/956>.  
- Prevod dela: Fakulteta za strojništvo

ISBN 978-961-286-964-9

doi: 10.18690/um.fs.2.2025

1. Fakulteta za strojništvo. angleški jezik

COBISS.SI-ID 230833155





© University of Maribor, University Press  
/ Univerza v Mariboru, Univerzitetna založba

Text © Fras Zemljič, Kreže, Novak (editors), 2025

This work is licensed under the Creative Commons Attribution 4.0 International License.

This license allows reusers to distribute, remix, adapt, and build upon the material in any medium or format, so long as attribution is given to the creator. The license allows for commercial use.

Any third-party material in this book is published under the book's Creative Commons licence unless indicated otherwise in the credit line to the material. If you would like to reuse any third-party material not covered by the book's Creative Commons licence, you will need to obtain permission directly from the copyright holder.

<https://creativecommons.org/licenses/by/4.0/>

**ISBN** 978-961-286-964-9 (pdf)  
978-961-286-965-6 (softback)

**DOI** <https://doi.org/10.18690/um.fs.2.2025>

**Price** Free copy

**For publisher** Prof. Dr. Zdravko Kačič, Rector of University of Maribor

**Attribution** Fras Zemljič, L., Kreže, T., Novak, M. (eds.). (2025). *Faculty of Mechanical Engineering: Research Guide*. University of Maribor, University Press. doi: 10.18690/um.fs.2.2025



# CONTENT

BRIEF HISTORY .....	1
FACULTY ORGANISATION .....	2
ORGANISATION AND SCOPE OF RESEARCH WORK .....	4
AREAS OF RESEARCH.....	5
<b>1. POWER, PROCESS AND ENVIRONMENTAL ENGINEERING .....</b>	<b>5</b>
1.1 LABORATORY FOR POWER SYSTEMS AND DEVICES .....	5
1.2 LABORATORY FOR ENGINE RESEARCH .....	8
1.3 LABORATORY FOR HEAT ENGINES AND ENGINEERING MEASUREMENTS .....	8
1.4 LABORATORY FOR TRANSPORT PHENOMENA IN SOLID AND LIQUIDS .....	11
1.5 LABORATORY FOR PROCESS ENGINEERING AND COMPUTATIONAL FLUID DYNAMICS .....	13
1.6 LABORATORY FOR THERMODYNAMICS, COMBUSTION AND ENVIRONMENTAL ENGINEERING .....	16
1.7 LABORATORY FOR TURBOMACHINERY .....	18
1.8 CENTRE FOR SENSORY TECHNIQUE .....	20
<b>2. CONSTRUCTION AND DESIGN .....</b>	<b>22</b>
2.1 LABORATORY FOR INTEGRATED PRODUCT DEVELOPMENT AND CAD .....	22
2.2 LABORATORY FOR PRODUCT DESIGN .....	26
2.3 LABORATORY FOR MACHINE ELEMENTS AND STRUCTURES.....	29
2.4 LABORATORY FOR MATERIAL HANDLING SYSTEMS AND LOGISTIC .....	33
2.5 LABORATORY FOR WELDING .....	36
2.6 LABORATORY FOR STRUCTURAL EVALUATION .....	41
2.7 LABORATORY FOR ADVANCED COMPUTATIONAL ENGINEERING AND EXPERIMENTING .....	44
<b>3. MATERIALS AND FORMING .....</b>	<b>48</b>
3.1 LABORATORY FOR MATERIALS .....	48
3.2 LABORATORY FOR MATERIALS FORMING .....	54
3.3 UNIVERSITY CENTRE FOR ELECTRON MICROSCOPY.....	58
<b>4. MECHANICS.....</b>	<b>64</b>
4.1 LABORATORY FOR APPLIED MECHANICS .....	64
<b>5. PRODUCTION ENGINEERING .....</b>	<b>67</b>
5.1 LABORATORY FOR ADDITIVE MANUFACTURING.....	67
5.2 LABORATORY FOR INTELLIGENT MANUFACTURING SYSTEM .....	71
5.3 LABORATORY FOR MECHATRONICS.....	74
5.4 LABORATORY FOR PRODUCTION AND OPERATION MANAGEMENT.....	78
5.5 LABORATORY FOR MACHINING PROCESSES .....	81
5.6 LABORATORY FOR OIL HYDRAULICS.....	84
5.7 LABORATORY FOR FLEXIBLE MANUFACTURING SYSTEM .....	88
5.8 LABORATORY FOR ROBOTISATION.....	90
5.9 LABORATORY FOR DISCRETE SYSTEMS SIMULATION .....	92
5.10 LABORATORY FOR PRODUCTION MEASUREMENT .....	95
<b>6. TEXTILE MATERIALS AND DESIGN .....</b>	<b>99</b>
6.1 LABORATORY FOR DYEING, COLORIMETRY AND FINISHING ECOLOGY .....	99
6.2 LABORATORY FOR CHEMISTRY AND ENVIRONMENTAL PROTECTION .....	105
6.3 LABORATORY FOR CHARACTERISATION AND PROCESSING OF POLYMERS .....	109
6.4 LABORATORY FOR CLOTHING ENGINEERING, PHYSIOLOGY AND GARMENT CONSTRUCTION .....	114
6.5 LABORATORY FOR FABRIC PLANNING AND CONSTRUCTION .....	117
6.6 LABORATORY FOR TEXTILE PRINTING AND TEXTILE CARE .....	120
6.7 CENTRE FOR TEXTILE CARE .....	120
6.8 CENTRE FOR DYEING AND COLOR.....	123
6.9 RESEARCH AND INOVATION CENTRE FOR DESIGN AND CLOTHING SCIENCE .....	124
<b>7. FUNDAMENTAL AND GENERAL SUBJECTS .....</b>	<b>130</b>
7.1 LABORATORY FOR PHYSICS.....	130
7.2 LABORATORY FOR MATHEMATICS.....	132



## PREFACE

---

Dear readers,

At the Faculty of Mechanical Engineering of the University of Maribor, we combine excellence, innovation and dedication to research at the highest level. We are among the leading academic institutions that make a significant contribution to the progress of science and society with their knowledge, research achievements and professional approach. We are proud to highlight our commitment to research activities, which range from basic research to applied technologies, which we transfer successfully into industrial practice.

Our laboratories and centres are equipped with excellent research equipment and the newest technology, which enables the implementation of complex research projects and testing of innovative solutions. By doing so, we create a stimulating environment for both students and researchers, who strive for breakthrough achievements. In addition, the faculty is involved in numerous national and international research programmes and projects, which allows us to collaborate with renowned research institutions and industrial partners around the world.

Close cooperation with the environment is key in our work, as this ensures that our research is relevant, practically applicable, and aimed at solving real challenges faced by modern industry. Our researchers are constantly looking for innovative approaches to increase efficiency, sustainable solutions and advances in technology, which contribute to increasing the competitiveness of the economy. We also nurture interdisciplinarity, as we believe that the most important achievements in the future will come from cooperation or networking of different fields.

The Faculty of Mechanical Engineering is much more than just an academic institution - it is a centre of research and technological progress that looks to the future and creates opportunities for new generations of engineers.

With the research guide, we want to present the diversity and quality of our research activities, so we invite you to read through it and experience our research world.

*Prof. Matej Vesenjak,  
Dean of the Faculty of Mechanical Engineering*

## PREFACE

---

Dear colleagues,

Welcome to reading the research guide of the Faculty of Mechanical Engineering of the University of Maribor. As the Vice-Dean for Research, I am extremely proud to introduce you to our diverse research activities, which connect several scientific fields and create a true interdisciplinary environment.

At the Faculty of Mechanical Engineering we cover numerous research areas, including manufacturing engineering, mechanics, construction and design, energy, process and environmental engineering, materials and transformation, and textile engineering materials and design. An important part of our activities is also basic and general subjects, which provide a solid scientific basis for all these areas. Our interdisciplinary orientation and synergistic cooperation between subdisciplines enable us to address contemporary research challenges comprehensively and innovatively.

Our infrastructure includes 35 laboratories and 5 research centres, where we combine research and development and transfer the acquired knowledge successfully into industrial practice. Research in all these areas is key to achieving our strategic goals and contributing to the societal and technological challenges of the future.

These research activities are not separate units – they work closely together, complement each other, and create interdisciplinary synergies that enable us to achieve research excellence. Our researchers demonstrate their commitment through successfully completed and ongoing national and international projects. We are particularly proud of our participation in European programmes such as Horizon 2020 and Horizon Europe, where we contribute to solving global challenges with our research and innovations and publish cutting-edge scientific publications.

With this interdisciplinary approach, we are also building future generations of researchers. Every year, we accept and train many young researchers, who are the driving force behind the future development of our faculty. With our joint pursuit of research excellence, innovation and solving complex challenges, we are shaping the future actively and implementing our slogan: Creating the future.

The research guide presents our laboratories, research centres and achievements. I wish you a lot of pleasure in reading and researching. A sincere thank you goes to all the researchers of the Faculty of Mechanical Engineering for being an indispensable part of our community.

It is with great pride and honor that I serve as Vice-Dean for Research on such an exceptional team.

*Prof. Lidija Fras Zemljič,  
Vice-Dean for Research FS  
in cooperation with the Service for Research Activities*

## BRIEF HISTORY

The beginnings of the activities of the Faculty of Mechanical Engineering of the University of Maribor (FS Maribor) date back to 1959, when, on 26 November, the People's Assembly of the Republic of Slovenia adopted the Act on the Establishment of the Higher Technical School in Maribor. Departments were established of Mechanical Engineering, Textiles and Electrical Engineering. The Department of Textile Technology has remained an integral part of the faculty to this day.

In 1973, the Higher Technical School developed into a college, and its largest department, the Department of Mechanical Engineering, began to implement a four-year Study Programme. We were the first to start postgraduate studies in Mechanical Engineering and awarded the first Master's and Doctorate degrees in 1976.

In 1975, the College of Engineering became a member of the newly established University of Maribor, and, after ten years, it developed into the Faculty of Engineering, with the Department of Mechanical Engineering becoming one of the four departments of the Faculty of Engineering, with programmes in Mechanical Engineering and Textile Engineering.

By 1995, the Faculty of Engineering had expanded to such an extent that it was transformed into four Faculties (the Faculty of Mechanical Engineering with the Department of Textiles, the Faculty of Civil Engineering, the Faculty of Computer and Information Science, and the Faculty of Chemistry and Chemical Technology).

Today, the Faculty of Mechanical Engineering contributes to the development of science, and to the technological progress of the economy and the social environment by combining high-quality scientific research, professional and educational work in the field of Engineering Sciences. The highest values of our work are:

- excellence, autonomy and openness of research and educational work,
- honesty, sincerity, professional ethics and social responsibility in research and education,
- the orientation of research and education towards the well-being of humanity and the creation of an inclusive society.



## FACULTY ORGANISATION

Name of the institution: University of Maribor, Faculty of Mechanical Engineering  
Address of the institution: Smetanova ulica 17, 2000 Maribor  
Web page: [www.fs.um.si](http://www.fs.um.si)



Dean  
**Prof. Matej Vesenjāk**  
Tel: +386 2 220 7501  
E-mail: [tajnistvo.fs@um.si](mailto:tajnistvo.fs@um.si)



Vice-Dean for Studies  
**Assis. Prof. Matej Zadravec**  
Tel: +386 2 220 7783  
E-mail: [matej.zadravec@um.si](mailto:matej.zadravec@um.si)



Vice-Dean for Scientific Research  
**Prof. Lidija Fras Zemljič**  
Tel: +386 2 220 7909  
E-mail: [lidija.fras@um.si](mailto:lidija.fras@um.si)



Vice-Dean for Cooperation with Industry and Quality Assurance  
**Prof. Iztok Palčič**  
Tel.: +386 2 220 7636  
E-mail: [iztok.palcic@um.si](mailto:iztok.palcic@um.si)



Vice-Dean for Student Affairs:  
**Peter Škrilec**  
E-mail: [studenti.fs.um.si](mailto:studenti.fs.um.si)



Faculty Secretary:  
**Mojca Jež Gole**  
Tel.: +386 2 220 7511  
E-mail: [mojca.jez@um.si](mailto:mojca.jez@um.si)

There are seven departments at the faculty that are responsible for academic, educational and research activities in their respective fields of activity:

- Chair for Production Engineering,
- Chair for Power, Process and Environmental Engineering,
- Chair for Construction and Design,
- Chair for Materials and Forming,
- Department for Mechanics,
- Chair for Textile Materials and Design,
- Chair for Fundamental and General Subjects.



Each chair is headed by a habilitated teacher, who is responsible for the functioning and high level of academic and professional competence of its members. The Chairs consist of several well-equipped laboratories and research groups, including exceptional researchers, which we demonstrate through numerous successfully completed and ongoing national projects. We are also well integrated into the international environment, which we demonstrate with many EU projects from the Horizon 2020 and Horizon Europe programmes. Our structural and cohesion programmes increase our visibility and competitiveness in research. In terms of the number of scientific publications, we are among the most active and successful at the University of Maribor and in Europe. Our PhDs are recognisable experts and are integrated into successful companies, and our motto is »Constant care for the intensive transfer of knowledge and the establishment of innovations in the economy«. We are always working on involving students in scientific research and thus empowering them to compete in the labour market.

#### HIGHER EDUCATION, RESEARCH AND ADMINISTRATIVE ASSOCIATES AND STUDENTS

Table 1: Number of higher education, research and administrative associates as of 29 February 2024 and the number of students enrolled in the academic year 2023/2024.

POSITION (by jobs)	FULL	PART	POSITION (by jobs)	FULL	PART
Full Professor	29	-	Scientific Advisor (Ph.D.)	3	1
Associate Professor	13	-	Senior Research Associate (Ph.D.)	1,5	-
Assistant Professor	10	-	Research Associate (Ph.D.)	6	6
Senior Lecturer	-	-	Senior Researcher (Ph.D.)	3,3	3
Lecturer	-	-	Researcher (MSc or Univ. BSc in Engineering)	8	1
Assistant	39,2	-	A young researcher (MSc or Univ. BSc in Engineering)	22	-
Practical Training Provider	1	-	Technical Associate and Technical Worker	14	-
<b>Total Higher Education Associates</b>	<b>92,2</b>	<b>-</b>	<b>Administrative and clerical staff</b>	<b>35</b>	<b>-</b>
			<b>Joint research and support staff</b>	<b>92,8</b>	<b>11</b>

Table 2: Number of students enrolled in the 2023/2024 academic year.

STUDENTS	ACADEMIC YEAR 2023/2024
Undergraduate Students	633
Postgraduate Students	352

The higher education and research staff of the Faculty of Mechanical Engineering pay special attention to domestic and international development trends, both theoretical and practical. Demanding markets and the development of new products and technologies require broader high-tech knowledge. Engineering professionals will remain key to development in the future, but this development will require, more than ever, environmental and energy constraints. This is one of the reasons why the engineers of the 21<sup>st</sup> century will be much more exposed to demanding projects, and why only engineers with sufficient interdisciplinary knowledge will be able to manage such projects.

## ORGANISATION AND SCOPE OF RESEARCH WORK

The Faculty of Mechanical Engineering of the University of Maribor is a scientific research and pedagogical institution which, due to the integration of activities and its success, is internationally comparable to similar institutions in Europe and the world. The results of the research are used directly in the educational process and in Study Programmes of all directions and levels (Undergraduate, Tertiary and Postgraduate Study Programmes).

Scientific research, applied research and development work include:

- basic and applied research,
- development research,
- training of young researchers,
- international projects,
- professional activity, consulting, analyses and
- transfer of knowledge to industry.

The basic Research Programme of the Faculty of Mechanical Engineering is included in the National Research Programme of the Republic of Slovenia, in international research projects, and also includes research and professional work for industry and external clients. The Dean's Office is responsible for the strategic planning, management and timely completion of basic and applied research.

The basic organisational unit for the implementation of research work is the Chair, which usually includes research groups and laboratories. The laboratories are the central cells for the implementation of basic, applied and development projects, in cooperation with renowned European research institutions. Many products of Slovenian and European companies include innovative achievements of researchers and students of the Faculty of Mechanical Engineering.

Students in the final years of Undergraduate Study Programmes can engage in research work, which is one of the most important measures of success and quality of study. Participation in the implementation of research projects is the best way for students to become aware of the interdisciplinary connection of mechanical engineering with other scientific fields, for example, Microprocessor Technology, Electronics, Ecology, Chemistry, Informatics, Logistics, Biotechnology, some branches of medicine, etc.

A brief overview of the research and development activities of the Faculty of Mechanical Engineering is presented below. The laboratory and centres operating at the Faculty of Mechanical Engineering are described.

## AREAS OF RESEARCH

1. POWER, PROCESS AND ENVIRONMENTAL ENGINEERING
2. CONSTRUCTION AND DESIGN
3. MATERIALS AND FORMING
4. MECHANICS
5. PRODUCTION ENGINEERING
6. TEXTILE MATERIALS AND DESIGN
7. FUNDAMENTAL AND GENERAL SUBJECTS

### 1. POWER, PROCESS AND ENVIRONMENTAL ENGINEERING

In the field of Power, Process and Environmental Engineering, there are 7 laboratories and 1 centre:

LABORATORY:	HEAD:
<a href="#">1.1 Laboratory for Power Systems and Devices</a>	Jure Marn
<a href="#">1.2 Laboratory for Engine Research</a>	Aleš Hribernik
<a href="#">1.3 Laboratory for Heat Engines and Engineering Measurements</a>	Aleš Hribernik
<a href="#">1.4 Laboratory for Transport Phenomena in Solid and Liquids</a>	Jure Ravnik
<a href="#">1.5 Laboratory for Process Engineering and Computational Fluid Dynamics</a>	Matjaž Hriberšek
<a href="#">1.6 Laboratory for Thermodynamics, Combustion and Environmental Engineering</a>	Niko Samec
<a href="#">1.7 Laboratory for Turbomachinery</a>	Ignacijo Biluš
<a href="#">1.8 Centre for Sensor Technique</a>	Aleksandra Lobnik



*Head of the Chair of Power, Process and Environmental Engineering*

**Prof. Matjaž Hriberšek**

*E-mail: [matjaz.hribersek@um.si](mailto:matjaz.hribersek@um.si)*

*Tel.: +386 02 220 7772*

*Web: <http://kepoi.fs.um.si/>*

#### 1.1 LABORATORY FOR POWER SYSTEMS AND DEVICES



*Head of the Laboratory*

**Prof. Jure Marn**

*E-mail: [jure.marn@um.si](mailto:jure.marn@um.si)*

*Tel.: +386 2 02 220 7773*

*Web: <http://kepoi.fs.um.si/sl/c/laboratorij-za-energetske-sisteme-in-naprave>*

The laboratory works in the field of transfer phenomena, such as heat transfer, and process phenomena such as evaporation and condensation, as well as in the field of energy in general. The excellent staff of the laboratory enable excellent scientific research and development work in the field of the design and implementation of energy systems or individual devices in the field of energy and in the field of determining comfort, heating and cooling or HVAC systems, as well as in the field of rational use of energy, determining the safety and reliability of energy systems and devices. Recently, we have also been intervening in the field of medicine, especially in heat transfer and thermoregulation, and the use of dynamic thermography to diagnose various diseases. The aim of our research is to develop energy systems and devices further, with greater efficiency, precision and sensitivity in the field of medicine than human thermoregulation and dynamic thermography, as this is the only

way to arrive at the parameters of the observed system. We have expert knowledge and tools to carry out theoretical, analytical, numerical and experimental studies, with an emphasis on the analysis of transfer phenomena, such as heat and energy transfer, which can be applied to various systems, such as power devices, and to humans.

#### MAJOR RESEARCH EQUIPMENT



##### **Thermal Camera FLIR T430sc Teledyne FLIR LLC**

FLIR T430sc is a portable thermal camera for field work, with a resolution of 320 x 240 pixels, the temperature range of measurement is from -20 °C to 650 °C with an NETD sensitivity of <30 mK, or an accuracy of  $\pm 2$  °C or 2%. The capture frequency is 60 Hz, the lens is 25° (18 mm).



##### **Thermal Camera FLIR A655sc Teledyne FLIR LLC**

The FLIR A655sc is a laboratory thermal camera for more accurate measurement of surface temperature, namely, a resolution of 640 x 480 pixels, the temperature range of the measurement is from -40 °C to 650 °C, with an NETD sensitivity of <30 mK, or an accuracy of  $\pm 2$  °C or 2%. The capture frequency is up to 200 Hz, with two lenses: 25° (24.6 mm) and 15° (88.9 mm).

#### SERVICE OFFER AND SUPPORT TO THE ECONOMY

- Development of mathematical-physical models of energy systems and devices for determining system efficiency or determination of process parameters.
- Determining the safety and reliability of energy systems.
- Implementation of numerical simulations in power engineering and process engineering in the field of Heat transfer.
- Development of new experimental measurements, and determination of the required process parameters in the power industry based on solving inverse problems.
- Development of new diagnostic methods in medicine, using dynamic thermography and innovative approaches for controlled human thermoregulation.
- Implementation of measurements of temperatures and heat losses in energy systems and devices in the field.
- Energy analyses and inspections.

#### COOPERATION WITH RESEARCH INSTITUTIONS

- JSI-Jožef Stefan Institute, Ljubljana, Slovenia
- University of Ljubljana, Faculty of Mechanical Engineering, Ljubljana, Slovenia
- UCLA Samueli School of Engineering, Los Angeles, California, USA
- Brunel University, London, United Kingdom

#### COOPERATION WITH COMPANIES

Energetika Maribor, d.o.o., A&E Europe, d.o.o., Eolka, proizvodnja elektra, d.o.o., Izoteh, d.o.o., Premogovnik Velenje, d.o.o., Ministry of the Environment and Spatial Planning - Nuclear Engineering Administration, Filo, d.o.o., STS - Solar Thermal Systems, d.d., NEK - Krško Nuclear Power Plant, d.o.o., Cimos, d.d., ZEN energija, d.o.o., Turna, d.o.o., Talum, d.d.

#### MOST IMPORTANT RESEARCH ACHIEVEMENT

Research in the field of Transferable phenomena, such as heat transfer in the field of Medicine, can have a significant impact on the development of new diagnostic methods, such as the use of dynamic thermography for the diagnosis of various diseases, skin cancer, breast cancer, vascular diseases, etc. Thus, in the laboratory,

we developed a rapidly advanced numerical method based on the MRE edge element method, to simulate heat biotransfer considering thermoregulation. This is an important step in solving inverse problems or the development of new diagnostic methods.

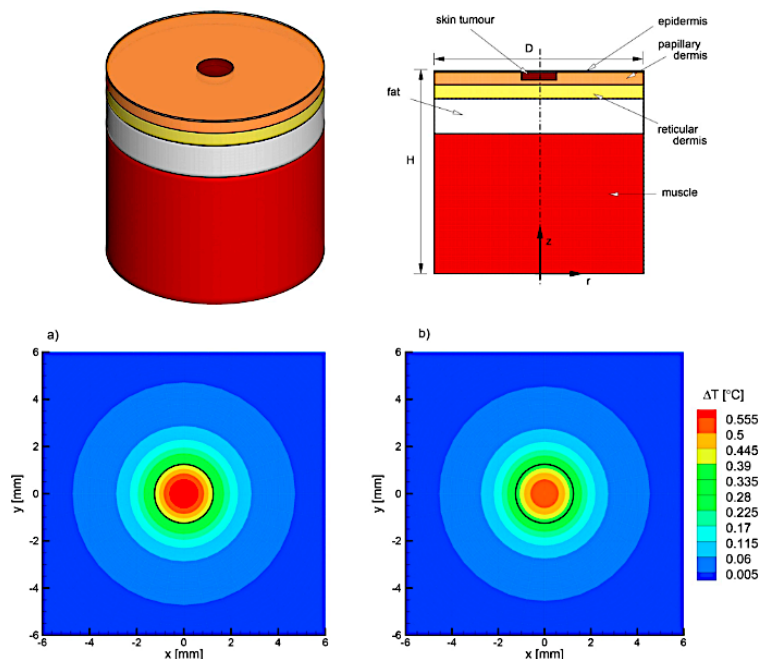

#### PUBLICATIONS

1. GOMBOC, Timi, ILJAŽ, Jurij, WROBEL, Luiz C., HRIBERŠEK, Matjaž, MARN, Jure. Design of constant temperature cooling device for melanoma screening by dynamic thermography. *Engineering analysis with boundary elements*. April 2021, vol. 125, str. 66–79. ISSN 0955-7997. DOI: 10.1016/j.enganabound.2021.01.009.
2. ILJAŽ, Jurij, WROBEL, Luiz C., GOMBOC, Timi, HRIBERŠEK, Matjaž, MARN, Jure. Solving inverse bioheat problems of skin tumour identification by dynamic thermography. *Inverse problems*. Feb. 2020, vol. 36, no. 3 (035002), str. 1–29. ISSN 1361-6420. DOI: 10.1088/1361-6420/ab2923.
3. ILJAŽ, Jurij, WROBEL, Luiz C., HRIBERŠEK, Matjaž, MARN, Jure. Numerical modelling of skin tumour tissue with temperature-dependent properties for dynamic thermography. *Computers in Biology and Medicine*. [Print ed.]. Sep. 2019, vol. 112, str. 1–15. ISSN 0010-4825. DOI: 10.1016/j.combiomed.2019.103367.
4. MARN, Jure, CHUNG, Mo, ILJAŽ, Jurij. Relationship between metabolic rate and blood perfusion under Fanger thermal comfort conditions. *Journal of Thermal Biology*. [Print ed.]. Feb. 2019, vol. 80, str. 94–105. ISSN 0306-4565. DOI: 10.1016/j.jtherbio.2019.01.002.
5. ILJAŽ, Jurij, ŠKERGET, Leopold, ŠTRAKL, Mitja, MARN, Jure. Optimization of SAE formula rear wing. *A machine gunner*. May 2016, vol. 62, no. 5, p. 263\u2012272, si 49, illus. ISSN 0039-2480. <http://www.dlib.si/details/URN:NBN:SI:doc-ISW7GJ25DOI:10.5545/sv-jme.2016.3240>

#### PATENTS AND PATENT APPLICATIONS

1. DOLENC, Sašo, DEMŠAR, Jurij, ULAGA, Aljaž, ŠTREMFEJ, David, TRDIČ, Francelj, MARN, Jure. Fiberizing apparatus and method of melt fiberization: patentna prijava: WO 2015116005 (A1), 2015-08-06. [Paris]: World Intellectual Property Organization (WIPO): International application published under the Patent Cooperation Treaty (PCT), 2015. str. 27.
2. MARN, Jure. Local Cooling Process and Device: Patent No. SI 24560 A, Date of Publication 30.6.2015, Application No. 201500022, Filing Date 9.2.2015. [Ljubljana]: Intellectual Property Office of the Republic of Slovenia, 2015. [I], p. 10, illus.
3. MARN, Jure, BRODAR, Renato. Process and device for asymmetrical supply of heat and cold: patent No. SI 24549 A dated 29.5.2015; Patent Application No. P-201500017 dated 6.2.2015. Ljubljana: Intellectual Property Office of the Republic of Slovenia, 2015. p. [18].
4. MARN, Jure. Process and device for increasing pressure in the recycling area: Patent No. SI 24536 A dated 29.5.2015; Patent Application No. P-201500028 dated 13.2.2015. Ljubljana: Intellectual Property Office of the Republic of Slovenia, 2015. p. [11].

## ARIS RESEARCH PROGRAMME P2-0196 Research in Power, Process and Environmental Engineering

### NATIONAL AND INTERNATIONAL PROJECTS

- Hydraulic transport of pasty materials. Premogovnik Velenje, d.o.o., 2000-2002
- Applicability of Computational Fluid Dynamics Programs for Simulation of Thermodynamic Phenomena in the Krško Nuclear Power Plant. Ministry of the Environment and Spatial Planning, Nuclear Safety Administration of the Republic of Slovenia, 2005.
- Hydraulic analysis of water collectors. STS – Solar Thermal Systems, d.d., 2006
- Flow through the recesses of segmented drum plates. Filo, d. o. o., 2015.
- Conducting an inspection of a steam boiler with a thermographic camera. A&E Europe, d.o.o., 2017.
- Energetski pregled podjetja A&E Europe, d. o. o, A&E Europe, d. o. o., 2017.
- Assessment of wind farm field noise. Eolka, proizvodnja elektroenerget, d. d., 2018.
- Analysis of the operation of the district heating system on the coast, Energija Plus, d. o. o., 2018.

### 1.2 LABORATORY FOR ENGINE RESEARCH

### 1.3 LABORATORY FOR HEAT ENGINES AND ENGINEERING MEASUREMENTS



*Head of Laboratories*

**Prof. Aleš Hribernik**

E-mail: [ales.hribernik@um.si](mailto:ales.hribernik@um.si)

Tel: +386 2 220 7731

Web: <http://kepoi.fs.um.si/sl/c/laboratorij-za-toplotne-stroje-in-tehniske-meritve>

Laboratory staff carries out experimental and numerical research of material flow and energy conversion in the heat engines. The heat engines are crucial for electricity and heat production. Currently one of the research areas is focused on conversion of plastic waste into fuel and its possible usage in internal combustion engines and other heat engine. The focus is on fuel injection, spray formation and possible effects on emissions formation. The laboratory disposes with own data acquisition (DAQ) system for temperature, pressure, displacement and flow measurements under different operating conditions. The staff uses NI software and hardware for measurement. The software for data acquisition, analysis and process control is developed for each application using the LabVIEW environment.

### MAJOR RESEARCH EQUIPMENT



#### Internal combustion engine test bench

The test bed consists of two engine brakes, Zoellner B-150 AC and Zoellner B-350 AC. The engine brakes enable rotational speeds of up to 6500 min<sup>-1</sup> and maximum torques of 1000 Nm and 2000 Nm. The supporting measuring equipment enable measurements of air flow, fuel consumption, temperatures and emissions. It is possible to measure in cylinder pressure.



#### Testing Facility for Mechanical High-Pressure Injection Systems Friedmann & Maier

The Friedmann & Maier test facility is dedicated to testing classic in-line diesel engine pumps. The system is additionally equipped with numerous sensors (pressure, needle lift and temperature), and is connected to the NI DAQ system for data acquisition.





### High-pressure chamber for fuel spray development recording

The chamber was developed according to our experience and requirements and is designed to enable the study of the development of the fuel spray jet under the conditions prevailing in the combustion chamber of a diesel engine at the time of fuel injection (pressures up to 60 bar). The chamber provides optical access from four directions and has a separate inert gas supply (N<sub>2</sub>). The chamber can be used in conjunction with a test bench for mechanical high-pressure injection systems.



### Laboratory Pyrolysis Reactor

The reactor allows the thermal decomposition of various polymer, composite or natural materials to be carried out. Processes in the reactor can be performed in inert atmosphere (e.g. N<sub>2</sub>) at temperatures up to 450 °C. Heat is supplied using an electric heater, which allows us to regulate the temperature in the reactor chamber. The system is computer-controlled (LabVIEW) and enables computer data acquisition and processing of measurement data.

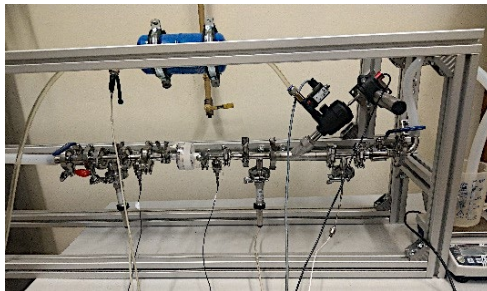

### Measuring system for measuring pressure fluctuations and filter loads

The system was developed for the pharmaceutical industry, for the purpose of validating the microfiltration process and analysing the factors that affect the load on filters due to the operation of quick-shut-off valves. The system works on the deterministic system NI cRIO 9047 and enables adjustment of valve timing and measurements the valve stroke, pressure waves, fluid flow and temperature.



### F-5000 E-Instruments Portable Exhaust Emission Analyser

The analyser is designed to monitor automotive emissions, and is ideal for engine setup and maintenance, pre-compliance checks and vehicle diagnostics. The F5000 includes computer software for real-time data logging with a Bluetooth connection. It enables the analysis of the following gas components of exhaust gases O<sub>2</sub>, CO<sub>2</sub>, CO, HC, NO and NO<sub>x</sub>.

## SERVICE OFFER AND SUPPORT TO THE ECONOMY

- Development of dedicated measurement applications and measurement systems in the field of Mechanical Engineering, based on measurement of temperature, pressure, displacement and frequency, deformations, as well as the velocity and flow of matter.
- Analysis of the effects of the alternative fuels use on the energy and emission characteristics of internal combustion engines.
- Production of energy estimates of the use of excess heat from energy and process plants using heat exchangers, heat pumps (mechanical or absorption) and circular processes with an organic working medium.
- Analysis of losses in the flow fields of hydroelectric power plants due to hydraulic resistances of grids and accumulated debris.

## COOPERATION WITH RESEARCH INSTITUTIONS

- University of Ljubljana, Faculty of Mechanical Engineering, Ljubljana, Slovenia
- University of Jaén, Jaén, Spain
- University of Sarajevo, Sarajevo, Bosnia and Herzegovina
- University of Rijeka, Rijeka, Croatia
- Energy and Climate Agency of Podravje, Maribor, Slovenia
- Dravske elektrarne Maribor, d. o. o., Maribor, Slovenia
- E-zavod, Slovenia

## COOPERATION WITH COMPANIES

IBE, d.o.o., HSE Invest, Simpos, d.o.o., LEK, d.o.o., RTI, d.o.o.

## MOST IMPORTANT RESEARCH ACHIEVEMENT

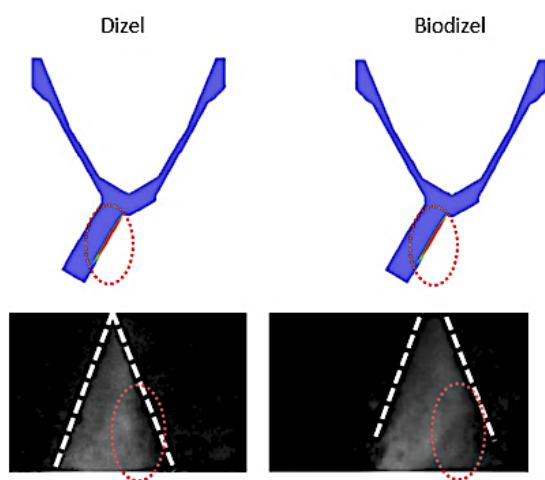

The research discusses **the influence of fuel properties on the occurrence of cavitation inside the injection nozzle of a diesel engine**, and on the process of primary breakup of the injected fuel spray jet. The part of the study, that deals with the phenomena of cavitation inside the injection nozzle, was performed using CFD computational program AVL FIRE. The process of primary spray jet breakup, was monitored experimentally, using a high-pressure fuel injection chamber and a high-speed camera. To process the images, obtained with the high-speed camera, an innovative method has been developed in the LabVIEW software environment, which allowed us to determine the length and angle of the injected fuel spray jet. The results obtained indicate that the geometry of the injection nozzle

has a major influence on the occurrence of cavitation, and that small changes in fuel properties do not have a significant effect on the angle and length of the fuel spray jet. From the comparison of numerical and experimental results can be concluded, that the occurrence of cavitation in the injection nozzle hole has a significant influence on the primary spray jet breakup, which is accelerated in the area of cavitation phase occurrence.

## PUBLICATIONS

1. BOMBEK, Gorazd, HRIBERNIK, Aleš. *Flow behaviour in vented brake discs with straight and airfoil-shaped radial vanes. Proceedings of the Institution of Mechanical Engineers. Part D, Journal of automobile engineering. First published online December 23, 2022, str. 1–17. ISSN 0954-4070. DOI: 10.1177/09544070221143623.*
2. HRIBERNIK, Aleš, BOMBEK, Gorazd, FIKE, Matej. *Phase-resolved PIV for investigating rotating stall within an axial fan. Flow measurement and instrumentation. Dec. 2019, vol. 70, str. 1–8, ilustr. ISSN 0955-5986. DOI: 10.1016/j.flowmeasinst.2019.101659.*
3. LEŠNIK, Luka, PALOMAR TORRES, A., TORRES JIMÉNEZ, Eloisa, MATA, C., VOLMAJER VALH, Julija, KEVORKIJAN, Luka, BILUŠ, Ignacijo. *The effect of HDPE and LDPE pyrolytic oils on cavitation formation in a common-rail diesel injector. Fuel. [Print ed.]. 15 December 2022, vol. 330 (125581), str. 14. ISSN 0016-2361. DOI: 10.1016/j.fuel.2022.125581.*
4. PALOMAR TORRES, A., TORRES JIMÉNEZ, Eloisa, KEGL, Breda, BOMBEK, Gorazd, VOLMAJER VALH, Julija, LEŠNIK, Luka. *Catalytic pyrolysis of plastic wastes for liquid oils' production using ZAP USY zeolite as a catalyst. International journal of environmental science and technology. Published: 28 February 2022. ISSN 1735-1472. DOI: 10.1007/s13762-022-04023-z.*
5. LEŠNIK, Luka, KEGL, Breda, BOMBEK, Gorazd, HOČEVAR, Marko, BILUŠ, Ignacijo. *The influence of in-nozzle cavitation on flow characteristics and spray break up. Fuel. [Print ed.]. 15 June 2018, vol. 222, str. 550–560. ISSN 0016-2361., DOI: 10.1016/j.fuel.2018.02.144.*

ARIS RESEARCH PROGRAMME P2-0196 Research in Power, Process and Environmental Engineering



#### 1.4 LABORATORY FOR TRANSPORT PHENOMENA IN SOLID AND LIQUIDS



*Head of the Laboratory*

**Prof. Jure Ravnik**

E-mail: [jure.ravnik@um.si](mailto:jure.ravnik@um.si)

Tel: +386 2 02 220 7745

Web: <http://jure.ravnik.si>

Open Source: <https://github.com/transport-phenomena>

The Laboratory for Transport Phenomena in Solids and Liquids, operating within the Faculty of Mechanical Engineering at the University of Maribor, focuses on advancing the understanding and application of energy, mass, and momentum transfer phenomena. Leveraging expertise in computational fluid dynamics (CFD), the laboratory develops proprietary numerical models and simulation tools while also enhancing and customizing commercial and open-source software to achieve high-precision simulations. Our work spans power, process, and environmental engineering, offering tailored solutions such as user-specific mathematical and physical models, software upgrades for process and environmental simulations, CFD training, optimization of high-performance computing resources, automated evaluation of simulation and experimental results, and comprehensive simulation and optimization services for engineering challenges.

#### SERVICE OFFER AND SUPPORT TO THE ECONOMY

- Development of user-adapted mathematical and physical models in the field of power, process and environmental engineering.
- Custom upgrade of commercial or open-source simulation software in the field of power, process and environmental engineering.
- Training in the application of computational fluid dynamics, efficient use of high-performance computer equipment, and efficient and automated evaluation of simulation and experimental measurement results.
- Implementation of simulations and optimisation of engineering solutions in the field of Energy, Process and Environmental Engineering.

#### COOPERATION WITH RESEARCH INSTITUTIONS

- School of Mechanical Science & Engineering, Huazhong University of Science & Engineering, Huazhong China
- Dokuz Eylül University, Izmir, Turkey
- Brno University of Technology, Brno, Czech Republic
- Eskişehir Technical University, Eskişehir, Turkey
- Institute ITeCons - The Institute for Research and Technological Development in Construction, Energy, Environment and Sustainability in Coimbra, Universidade de Coimbra, Coimbra, Portugal
- University of Washington Bothell, USA
- Gestionale e Meccanica of the University of Udine, Udine, Italy
- A. N. Podgorny Institute for Mechanical Engineering Problems Faculty of the National Technical University (Kharkov Polytechnic Institute), Kharkiv, Ukraine
- Graz University of Technology, Graz, Austria
- Wessex Institute of Technology, Ashurst, United Kingdom
- Chair of Fluid Mechanics, Faculty of Engineering, Friedrich-Alexander-University, Erlangen-Nuremberg, Germany
- Chair of Mechanical Engineering, Faculty of Engineering, Friedrich-Alexander-University, Erlangen-Nuremberg, Germany
- Faculty of Mechanical Engineering and Naval Architecture, University of Zagreb, Croatia
- University of Split, Faculty of Electrical Engineering, Mechanical Engineering and Naval Architecture, Split, Croatia
- Institute of Fluid Mechanics and Hydraulic Turbomachinery, University of Stuttgart, Stuttgart Germany

### COOPERATION WITH COMPANIES

Hella Saturnus, d.o.o., LEK, d.d., Novartis, Herz, d.o.o., Hisense Gorenje, d.o.o., Dravske Elektranarne Maribor, d.o.o., Public Energy Agency of the Republic of Slovenia, Plinarna, d.o.o., HERA, VGB - Water Management Bureau Maribor, d.o.o., Cinkarna Celje, d.d., Institute for Environmental Engineering, d.o.o.

### MOST IMPORTANT RESEARCH ACHIEVEMENT

#### Research on the behaviour of inhaled droplets in the human airways.

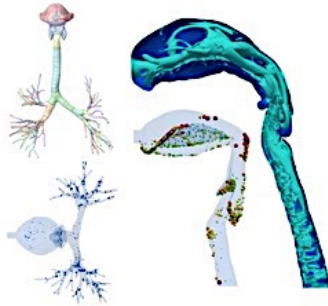

As the Covid epidemic evolved, we responded and contributed to the understanding of droplet deposition in the human respiratory tract. We investigated the influence of activity level, age, room size, and compared the behaviour of exhaled droplets with the behaviour of droplets produced by sneezing and coughing. Furthermore, we developed a numerical model that allows simulations of flows with particles that are non-spherical in shape. In process and environmental engineering, we often encounter problems involving the movement of non-spherical particles in liquids.

### PUBLICATIONS

1. *Powder Technology*, (2024), doi: 10.1016/j.powtec.2024.119526
2. *Computer Methods and Programs in Biomedicine*, (2024), doi: 10.1016/j.cmpb.2024.108203
3. *Physics of Fluids*, (2023). doi: 10.1063/5.0143795
4. *International Journal of Multiphase Flow* (2023), doi: 10.1016/j.ijmultiphaseflow.2022.104283
5. *Computational Particle Mechanics*. (2023) doi: 10.1007/s40571-023-00618-6

### ARIS RESEARCH PROGRAMME P2-0196 Research in Power, Process and Environmental Engineering

#### NATIONAL AND INTERNATIONAL PROJECTS

- J7-60118: Human radiation exposure due to the use of new wireless communication technologies based on advanced electromagnetic-thermal dosimetry models, 2025 - 2028.
- Modelling of current and temperature conditions in rotating elements, 01.07.2011 – 30.06.2014.
- Numerical and Experimental Analysis of Non-Stationary Phenomena in Reversible Pumps - Turbines, 1.2.2012 - 30.01.2011.
- Numerical simulation of turbulent flow with velocity vortex simulation of large vortices using the edge element method, 1.1.2007 - 31.12.2008.
- DFG research project: A numerical model for translational and rotational momentum transfer of soft deformable micro particles in dilute two-phase flows, 2023 - 2026.
- BI-TR/22-24-05: Evaluation of nanofluid modelling strategies in heat exchangers operating with natural convection, 2022 - 2024.
- BI-CN/20-22-002 Analysis of the deposition of aerosol droplets inhaled using a nebuliser in the human respiratory tract, 2021 - 2023.
- DFG research project: A numerical model of translational and rotational momentum transfer of small non-spherical rigid particles in fluid dominated two-phase flows, 2018 - 2022.
- COST Innovators Grants (CIG): NANOConVEX, <https://nanoconvex.eu/> 2021 - 2022.
- COST NANOUPTAKE Overcoming Barriers to Nanofluids Market Uptake CA15119.
- BI-HR/18-19-010 Development of a method for coupled simulation of liquid flow and bioelectromagnetic phenomena, 2018 - 2019.
- BI-UA/09-10-011 Development of a rapid edge element method for use in fluid mechanics, 2013 - 2014.
- BI-US/15-16-038 Simulation of nanofluids using the edge element method, 2015 - 2016.

### MEMBERSHIPS

- ECCOMAS, <https://eccomas.org>
- ERCOFTAC, <https://www.ercoftac.org>

## 1.5 LABORATORY FOR PROCESS ENGINEERING AND COMPUTATIONAL FLUID DYNAMICS



*Head of the Laboratory*

**Prof. Matjaž Hriberšek**

E-mail: [matjaz.hribersek@um.si](mailto:matjaz.hribersek@um.si)

Tel.: +386 202 220 7772

Web: <http://kepoi.fs.um.si/sl/c/laboratorij-za-procesno-inzenirstvo-in-racunalnisko-dinamiko-tekocin>

Researchers and development engineers often have only a rough idea of which parts of a device are not optimal, but they don't know exactly why. In such cases, computer simulation of the operation of the device can reveal the causes of the defects, which allows engineers to identify these defects already in the process of developing the device, and eliminate them, or improve the performance of the device. Especially for devices that operate with liquids (gases or liquids), optimisation with classical engineering approaches such as dimensional analysis and model experiments is of very limited use, which highlights the importance of computer simulation in the development of these systems. The field of development of computational methods for simulating the flow of liquids and the transfer of heat and mass in multiphase systems, which characterises what is happening in most process devices, is, thus, the central area of the laboratory's research work. With the advancement of the computing power of accessible computer systems, research work overlaps increasingly with research and development work for the Slovenian industry, which is recognising the added value of such solutions increasingly, as well as for international companies. Among the many examples of good practice, we highlight the development of the sublimation drying model, which is the basis of the developed digital twin of the freeze dryer for use in pharmaceuticals, the model of fouling and loading of the microfiltration membrane for the implementation of sterile filtration, the spray drying model, and the development of advanced models for the analysis of thermal and moisture loads in modern automotive lighting. We also support the development of computer models by validations in a modern experimental laboratory.

### MAJOR RESEARCH EQUIPMENT



#### Cleanroom Cleangrad

Temperature-controlled room for conducting tests of various devices and procedures in controlled thermal conditions as well as in conditions of low particle counts.



#### Laboratory lyophiliser LIO 2000 LFT Kambič, FS UM

A lyophiliser for test sublimation drying in conditions of low pressure (up to 5 Pa) and low temperatures (up to - 40 °C). Suitable for pharmaceuticals, food products, aqueous suspensions of solid particles (nanocellulose, microparticles, etc.). Measurement of the temperature field in the product at different depths in the substance. Optimisation (time, temperature) of the process using computer modelling methods.



#### Laboratory drum for particle coating FS UM

A laboratory device for coating particles with aqueous suspensions and solutions. Solution feed via a nozzle with simultaneous convection drying in a frequency-controlled rotating perforated drum. It is possible to develop a computer model for the calculation of the coating and drying of moist porous particles. It includes a system for characterising the size and measuring the velocity of dispersed particles and droplets in real time.



#### Mixing system IKA/ Dryer with fluidized bed, IKA, FS UM

A mixing device for mixing in mixing vessels up to 10 l. The use of different types of mixers. It has an aeration system. Torque measurement and power characteristics for non-Newtonian fluids. Possible combination with 3D computer mixing calculation. The floating layer dryer allows you to test the fluidisation rate of particles and dry smaller quantities of wet particles. It is possible to develop a computer model to calculate the drying of the target moist porous particle.

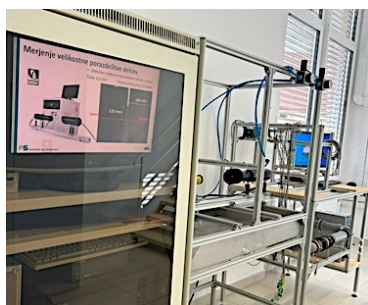

#### Experimental system for the characterisation of microfilters FS UM

A system for measuring pressure conditions in systems with a filter in conditions of continuous operation, as well as the closing/opening of valves (hydraulic shock). Measuring the characteristics of the filters. Possible combination with the development of computational models for filter fouling, and models for calculating the energy loads on filtration membranes.



#### Computer system with computer lecture room Ansys HP/Ansys

Using the FS HPC-CORE computer cluster, computer lab –classroom with 15 workstations. Programs: ANSYS Fluent, Ansys CFX, AVL-FIRE, OpenFOAM.

### SERVICE OFFER AND SUPPORT TO THE ECONOMY

- Development of experimental and computational models for the testing and optimisation of devices and procedures, with an emphasis on computational fluid dynamics and procedures in process engineering.

### COOPERATION WITH RESEARCH INSTITUTIONS

- Friedrich Alexander University of Erlangen Nuremberg, Erlangen, Germany
- Huazhong University of Science and Technology (HUST), Wuhan, China
- University of Udine, Udine, Italy
- Technical University Vienna, Vienna, Austria
- University of Zagreb, Zagreb, Croatia
- University of Rijeka, Rijeka, Croatia

### COOPERATION WITH COMPANIES

LEK, d.d., Slovenia; Novartis, d.o.o., Slovenia; Weishaupt GmbH, ZRN; RCPE, Austria; Plinacro, Croatia; HERA, Croatia, Hella Saturnus, Slovenia, Hisense Gorenje, Slovenia, BSH Nazarje, Slovenia; DEM, Slovenia; Nanocrystacell, d.o.o., Slovenia; ROTO, d.o.o., Slovenia; SILKEM, d.o.o., Slovenia; Nanocrystacell, Slovenia.

### MOST IMPORTANT RESEARCH ACHIEVEMENT

#### Development of a computer model of freeze-drying for use in scale-up procedures in pharmaceutical practice.

The modelling and simulation of the freeze-drying process for use in the development and transfer of the technological process, developed within the framework of a long-term cooperation with the company LEK, enables a better understanding and simplification of the development and transfer of the process, the reduction of costs and the reduction of energy consumption consumed in the freeze-drying process. The developed computational model and virtual simulation of freeze-drying enables faster and more cost-effective development and transfer of the process, and, since the development is based on knowledge and understanding of the process, the risk of errors and problems is also reduced in large-scale technological transfer i.e. scale-up

procedures. The developed computational model of the freeze drying in the vial forms the basis for the in-house developed and practically verified 3D computer model of the entire freeze dryer, verified both on a laboratory scale (300 vials) and on an industrial scale (60,000 vials).

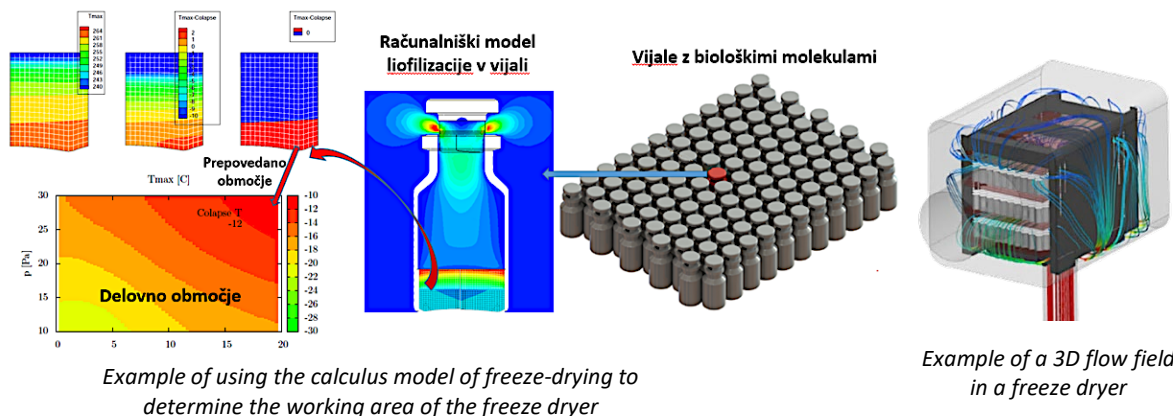

## PUBLICATIONS

1. KAMENIK, Blaž, HRIBERŠEK, Matjaž, ZADRAVEC, Matej. Simulation of ice deposition in a freeze dryer condenser: a computational fluid dynamics study. *Applied thermal engineering*. June 2024, vol. 247, DOI: 10.1016/j.applthermaleng.2024.123019.
2. RAMŠAK, Matjaž, HRIBERŠEK, Matjaž. Vial wall effect on freeze-drying speed. *Journal of pharmaceutical sciences*. May 2024, vol. 113, iss. 5, DOI: 10.1016/j.xphs.2023.12.005.
3. WEDEL, Jana, STEINMANN, Paul, ŠTRAKL, Mitja, HRIBERŠEK, Matjaž, RAVNIK, Jure. Risk assessment of infection by airborne droplets and aerosols at different levels of cardiovascular activity. *Archives of computational methods in engineering*. [Print ed.]. Oct. 2021, vol. 28, iss. 6, str. 4297–4316.
4. GOMBOC, Timi, ZADRAVEC, Matej, ILJAŽ, Jurij, SAGADIN, Gregor, HRIBERŠEK, Matjaž. Numerical model of three stage spray drying for zeolite 4A – water suspensions coupled with a CFD flow field. *International journal of simulation modelling*. June 2019, vol. 18. DOI: 10.2507/IJSIMM18(2)462.
5. GOMBOC, Timi, ILJAŽ, Jurij, RAVNIK, Jure, HRIBERŠEK, Matjaž. Spherical porous particle drying using BEM approach. *Engineering analysis with boundary elements*. Nov. 2019, vol. 108. DOI: 10.1016/j.enganabound.2019.07.019

## ARIS RESEARCH PROGRAMME P2-0196 Research in Power, Process and Environmental Engineering

### NATIONAL AND INTERNATIONAL PROJECTS

- Freeze-drying modelling. LEK, d. d., 2015-2020.
- Filtration modelling. Novartis, d.o.o., 2020-2023.
- Modelling of thermal conditions in automotive lamps. Hella Saturnus, 2012-2023.
- A numerical model of translational and rotational momentum transfer of small non-spherical rigid particles in fluid dominated two-phase flows. DFG (ZRN) raziskovalni projekt, 2016–2020.
- A numerical model for translational and rotational momentum transfer of soft deformable micro particles in dilute two-phase flows. DFG (ZRN) raziskovalni projekt, 2021–2026.
- CFD Lyophilisation modelling. RCPE (Avstrija), 2021–2025.
- Numerical simulations of combustion phenomena in an industrial burner by parallel CFD. MAX WEISHAUPT GmbH (ZRN), 2020–2025.
- Modelling of current and temperature conditions in rotating elements. ARIS L2-4082, 2012-2014.
- Parallel iterative strategies for solving problems of the computational fluid dynamics of spatial flow. ARIS Z2-7992, 1998-2001.
- Development of hydraulic characteristics of water turbines. ARIS Z2-7992, 1999-2000.

### MEMBERSHIPS

- GAMM - Society for Applied Mechanics and Mathematics
- ERCOFTAC - European Research Community on Flow, Turbulence and Combustion
- WYD - Slovenian Society of Mechanics
- SZE - Slovenian Energy Association



## 1.6 LABORATORY FOR THERMODYNAMICS, COMBUSTION AND ENVIRONMENTAL ENGINEERING



*Head of the Laboratory*

**Prof. Niko Samec**

E-mail: [niko.samec@um.si](mailto:niko.samec@um.si)

Tel.: +386 2 220 7733

Web: <http://kepoi.fs.um.si/sl/c/laboratorij-za-termodinamiko-zgorevanje-in-okoljsko-inzenirstvo>

Modelling, control and prevention of the impact of industrial and municipal pollution on the environment are important contents of environmental engineering. This area also includes the problems of the use of new and alternative fuels and the rational use of existing fuels, especially from the point of view of increasing the efficiency of combustion and reducing the production of harmful substances. A large part of the research is represented by numerical modelling and simulation of combustion processes. The scope of application extends to all types of industries where problems with waste substances occur, as well as to the field of Municipal Waste, its storage and environmentally friendly destruction or recycling. Research is important for preserving the environment and human health and enables the sustainable use of natural resources and the reduction of the negative impacts of industrial activities on the environment.

### MAJOR RESEARCH EQUIPMENT

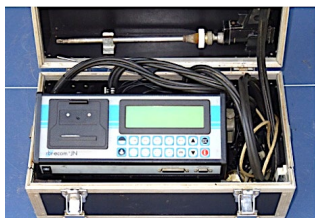

#### **Gas Combustion Product Analyser RBR Ecom**

It allows measurements of concentrations of flue gas components to be carried out.



#### **TOC analyser**

It allows the determination of the total organic carbon in substances.



#### **Bomb calorimeter IKA C 6000**

It allows you to determine the upper and lower calorific values of solid fuels and burn the residue.

### SERVICE OFFER AND SUPPORT TO THE ECONOMY

- Numerical modelling and simulation of combustion processes of gaseous, liquid and solid fuels.
- Designing flue gas cleaning procedures.
- Flue gas analysis.
- Thermodynamic properties of renewable fuels.
- Waste energy recovery processes.
- Optimisation of waste management processes.

### COOPERATION WITH RESEARCH INSTITUTIONS

- University of Ljubljana, FS, Ljubljana, Slovenia

- Elektroinstitut Milan Vidmar, Ljubljana, Slovenia
- Institute for Environmental Protection and Sensors, Maribor, Slovenia
- University of Zagreb, FSB, Zagreb, Croatia
- University of Belgrade, FS, Belgrade, Serbia
- University of Podgorica, FS, Podgorica, Montenegro

### COOPERATION WITH COMPANIES

AlpaCem Anhovo, TEŠ, HSE, Energetika Celje, Energetika Maribor, Snaga Maribor, Surovina Maribor, Cinkarna Celje, Valtis Maribor, Voka Celje, Weishaupt Schwendi, etc.

### MOST IMPORTANT RESEARCH ACHIEVEMENT

We have developed an empirical numerical **model of the graduated combustion of small particles of solid fuels** on a cylindrical grid, with the aim of reducing PM5 and NOx emissions.

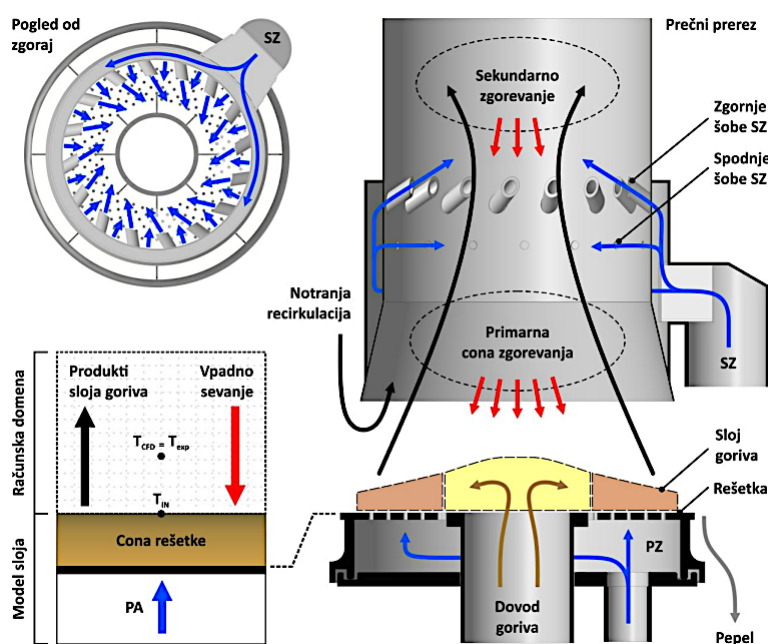

Combustion simulation strategy by stages

### PUBLICATIONS

1. KOKALJ, Filip, ZADRAVEC, Tomas, JOVOVIĆ, Aleksandar M., SAMEC, Niko. Small wood pellet boiler 3-D CFD study for improved flue gas emissions employing flue gas recirculation and air staging. *Thermal science*. 2023, vol. 27, iss. 1, str. 89–101. ISSN0354-9836. TWO:10.2298/TSCI2301089K. [COBISS. SI-ID144637187], [JCR,SNIP,Wos,Scopus]
2. ZADRAVEC, Tomas, RAJH, Boštjan, KOKALJ, Filip, SAMEC, Niko. The impact of secondary air boundary conditions on CFD results in small-scale wood pellet combustion. *Fuel*. [Print ed.]. 15 September 2022, vol. 324 (124451), str. 19. ISSN 0016-2361. DOI:10.1016/j.fuel.2022.124451. [COBISS. SI-ID108600835], [JCR,SNIP,Wosuntil 02/09/2023: Citations (TC): 4, Clean Citations (CI): 3, Pure Citations Per Author (CIAu): 0.75,Scopusto 05/09/2023: Citations (TC): 4, Pure Citations (CI): 3, Pure Citations Per Author (CIAu): 0.75]
3. ZADRAVEC, Tomas, RAJH, Boštjan, KOKALJ, Filip, SAMEC, Niko. Influence of air staging strategies on flue gas sensible heat losses and gaseous emissions of a wood pellet boiler: An experimental study. *Renewable energy*. [Print ed.]. Nov. 2021, vol. 178, str. 532–548, ilustr. ISSN 0960-1481. DOI:10.1016/j.renene.2021.05.150. [COBISS. SI-ID73900291], [JCR,SNIP,Wosuntil 2023-08-26: Citations (TC): 14, Pure Citations (CI): 11, Pure Citations Per Author (CIAu): 2.75,Scopusuntil 02/09/2023: Citations (TC): 16, Pure Citations (CI): 13, Pure Citations Per Author (CIAu): 3.25]
4. ZADRAVEC, Tomas, RAJH, Boštjan, KOKALJ, Filip, SAMEC, Niko. CFD modelling of air staged combustion in a wood pellet boiler using the coupled modelling approach. *Thermal science and engineering progress*. [Online ed.]. 1 Dec. 2020, vol. 20, [art. no.] 100715, str. 1–13. ISSN 2451-9049. DOI:10.1016/j.tsep.2020.100715. [COBISS. SI-ID33172483], [JCR,SNIP,Wosuntil 12/08/2023: Citations (TC): 14, Pure Citations (CI): 11, Pure Citations Per Author (CIAu): 2.75,Scopusto 09/09/2023: Citations (TC): 20, Pure Citations (CI): 17, Pure Citations Per Author (CIAu): 4.25]

## PATENTS AND PATENT APPLICATIONS

- EKART, Janez, KOKALJ, Filip, SAMEC, Niko, BRUMEC, Vilijana, FIŠER, Jure, KROŠLIN, Tadej, POLANEC, Brigita, KURNIK, Natalija, DVORŠAK, Slavko, KOVAČ, Peter. Process of obtaining solid fuels with certain physicochemical properties from non-hazardous waste materials: Patent No. SI 23896 A of 30.4.2013, Patent application No. P-201100389 dated 29.9.2011. Ljubljana: Intellectual Property Office of the Republic of Slovenia, 2013. [11, 2] p. [COBISS. SI-ID 16936726]category: SU (S); the type of work is verified by OSICT.
- OJSTRŠEK, Alenka, ROŠ, Milenko, LOBNIK, Aleksandra, FAKIN, Darinka, SAMEC, Niko. Process of Textile Dyeing Wastewater Treatment with a Combination of Natural Biomass Carriers in a Biofilter: Patent No. SI22584 (A), 2009-02-28. Ljubljana: Intellectual Property Office of the Republic of Slovenia, 2009. [2] f. [COBISS. SI-ID 11844118]category: SU (S); the type of work is verified by OSICT.

ARIS RESEARCH PROGRAMME P2-0196 Research in Power, Process and Environmental Engineering

## NATIONAL AND INTERNATIONAL PROJECTS

- ERASMUS + Greenes
- ERASMUS + WamPPP
- Bilateral projects with Montenegro, Denmark and China

## MEMBERSHIPS

- Chamber of Engineers of Slovenia
- Adria Section of the Combustion Institute

## 1.7 LABORATORY FOR TURBOMACHINERY



*Head of the Laboratory*

**Assoc. Prof. Ignacijo Biluš**

*E-mail: [ignacijo.bilus@um.si](mailto:ignacijo.bilus@um.si)*

*Tel: +386 2 220 7742*

*Web: <http://kepoi.fs.um.si/sl/c/laboratorij-za-turbinske-stroje>*

The laboratory performs comprehensive numerical simulations and experimental research that focus on the analysis of fluid flow phenomena in the turbomachinery. We are investigating the phenomenon of cavitation actively, which includes numerical and experimental prediction of cavitation operating characteristics and erosion in combination with particle abrasion.

Our research includes the determination of the integral operating characteristics, the analysis of secondary phenomena, and the measurement of vibration and noise in different operating regimes of hydraulic systems. The latter is important for improving the efficiency of hydraulic machines, reducing operating costs, increasing operational reliability and developing sustainable energy systems.

## MAJOR RESEARCH EQUIPMENT



### Setup for measuring the operating characteristics of fans, UM FS LTS

The setup enables the measurement of operating characteristics (energy difference, volumetric flow, torque, driving power, hydraulic power, efficiency) of fans and blowers up to a power of 5.5 kW.



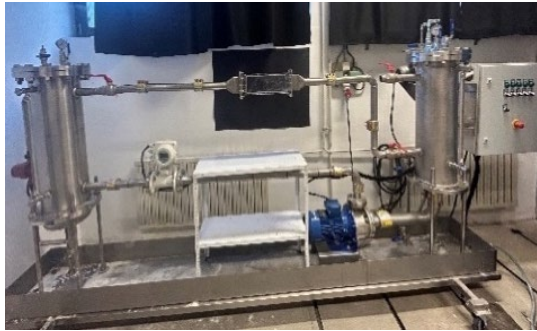

**Cavitation measuring line.** The experimental measuring setup enables the analysis and visualisation of cavitation operating regimes on submerged bodies at variable system pressures. On the surface of submerged bodies (inserts), it is possible to monitor or predict cavitation erosion by the method of painting the surface of the insert. The measuring setup can also operate with suspended solids, which makes it possible to monitor the abrasion of the surface due to the action of particles in the stream.



**Setup for measuring the characteristics of water pumps UM FS LTS**

The setup enables the measurement of basic and cavitation operating characteristics of water pumps up to a flow rate of 63 m<sup>3</sup>/h and a power of up to 7.5 kW. Analysis and visualisation of cavitation fluctuations in the suction pipe of the pump are also possible at the setup.



**Wind Turbine Characteristics Measurement Setup UM FS LTS**

The setup enables the determination of the basic characteristics of model wind turbines up to a diameter of 0.5 m in the external flow. An electric generator with variable torque and a measuring system for measuring the rotational frequency, torque and electrical voltage and current on the generator is connected to the rotor of the wind turbine.



**Noise Meter CR:831B Cirrus Research plc.**

The CR:831B noise meter can measure noise from 21 dB(A) to 140 dB(A), or from 14 dB(Z) to 140 dB(Z).

**SERVICE OFFER AND SUPPORT TO THE ECONOMY**

- Implementation of measurements of flow, pressure, vibration, noise in the field.
- Performing measurements of the operating characteristics of rotary turbomachines.
- Numerical simulations in hydraulic flow systems.
- Energy analyses and inspections.

**COOPERATION WITH RESEARCH INSTITUTIONS**

- University of Ljubljana, Faculty of Mechanical Engineering, Ljubljana, Slovenia
- Graz University of Technology, Graz, Austria
- International University of Rijeka, Faculty of Civil Engineering, Rijeka, Croatia
- University of Novi Sad, Faculty of Technical Sciences, Novi Sad, Serbia
- University of Trieste, Faculty of Civil Engineering, Trieste, Italy

**COOPERATION WITH COMPANIES**

Paloma, d.d., Dravske elektrarne Maribor, d.o.o., Messer Slovenija, d.o.o., Palfinger proizvodnja, d.o.o., Menerga, d.o.o., Bodočnost Maribor, d.o.o., Plineks, d.o.o., Kovinarstvo Bučar, d.o.o.

## MOST IMPORTANT RESEARCH ACHIEVEMENT

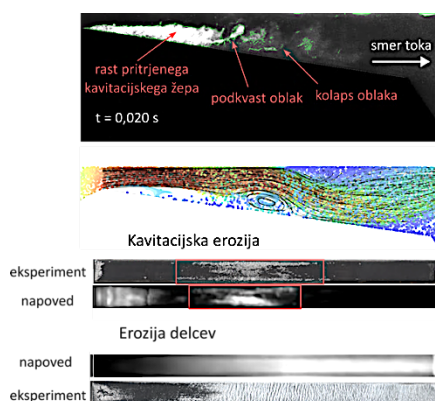

In hydraulic systems damage often occurs due to cavitation, which can occur in the flow when the pressure drops, and due to particles, that may be present in the flow. In addition to the ability to predict flow and flow phenomena with Computational Fluid Dynamics (CFD), the prediction of the occurrence of erosion due to cavitation and particles in the flow is of great importance for the design of hydraulic systems. We compiled a **numerical model that allows the prediction of erosion** due to cavitation and particulate matter as part of a commercial CFD programme and validated it on the example of a Venturi channel.

## PUBLICATIONS

1. KEVORKIJAN, Luka, LEŠNIK, Luka, BILUŠ, Ignacijo. Cavitation erosion modelling on a radial divergent test section using RANS. *A machine gunner*. 2022, vol. 68, iss. 2, p. 71-81. ISSN 0039-2480. DOI: 10.5545/sv-jme.2021.7364.
2. BILUŠ, Ignacijo, HOČEVAR, Marko, DULAR, Matevž, LEŠNIK, Luka. Numerical prediction of various cavitation erosion mechanisms. *Journal of fluids engineering: Transactions of the ASME*. April 2020, vol. 142, iss. 4, str. 041402-1-041402-8. ISSN 0098-2202. DOI: 10.1115/1.4045365.
3. BILUŠ, Ignacijo, LEŠNIK, Luka. Experimental and numerical analysis of a wind turbine model. *Machines, technologies, materials*. [Print ed.]. 2019, year 13, iss. 5, str. 206–209, ilustr. ISSN 1313-0226.
4. BILUŠ, Ignacijo, BIZJAN, Benjamin, LEŠNIK, Luka, ŠIROK, Brane, PEČNIK, Boštjan, DULAR, Matevž. Non-contact method for analysis of cavitating flows. *Ultrasonics*. 2017, vol. 81, p. 178-186, illus. ISSN 0041-624X. <https://repozitorij.uni-lj.si/izpisGradiva.php?id=126835>, DOI: 10.1016/j.ultras.2017.03.011.
5. LEŠNIK, Luka, PALOMAR TORRES, A., TORRES JIMÉNEZ, Eloisa, MATA, C., VOLMAJER VALH, Julija, KEVORKIJAN, Luka, BILUŠ, Ignacijo. The effect of HDPE and LDPE pyrolytic oils on cavitation formation in a common-rail diesel injector. *Fuel*. [Print ed.]. 15 December 2022, vol. 330 (125581), 14 str. ISSN 0016-2361. DOI: 10.1016/j.fuel.2022.125581.

## ARIS RESEARCH PROGRAMME P2-0196 Research in Power, Process and Environmental Engineering

### 1.8 CENTRE FOR SENSOR TECHNIQUE



Head of the Centre  
**Prof. Aleksandra Lobnik**  
 Tel: +386 2 220 7912  
 E-mail: [aleksandra.lobnik@um.si](mailto:aleksandra.lobnik@um.si)

The Centre for Sensor Technique (CST), founded in 2001 at the Faculty of Mechanical Engineering, is dedicated to environmental and health protection, and performs standardised environmental measurements. It specialises in the development of new methods and sensors for determining the ecological parameters of wastewater, and technological and process parameters in various industrial sectors. Great emphasis is placed on the development of biosensors, microsensors and sol-gel nanomaterials and their practical application. CST also participates actively in the transfer of knowledge to industry through seminars, courses and participation in national and European development projects. It organises educational events such as workshops, conferences and seminars, among which the NANOAPP conference stands out. It collaborates with various domestic and international laboratories and institutes and is part of the Centre of Excellence for Nanoscience and Nanotechnologies, NANOCENTRE.

The activities of the Centre for Sensor Technique (CST) include the areas of water and waste recycling, the development of optical chemical and biochemical sensor receptors, and the development of nanomaterials for environmental and sensory applications. As a co-author, CST has contributed to more than 30 patents and patent applications, 15 of which are international.

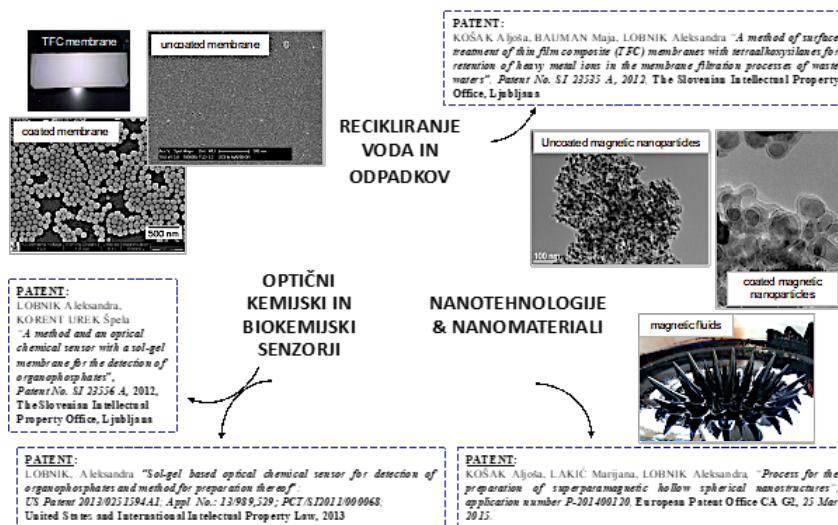

## 2. CONSTRUCTION AND DESIGN

In the field of Construction and Design, there are 7 laboratories:

LABORATORY:	HEAD:
<a href="#">2.1 Laboratory for Integrated Product Development and CAD</a>	Bojan Dolšak
<a href="#">2.2 Laboratory for Product Design</a>	Sonja Šterman
<a href="#">2.3 Laboratory for Machine Elements and Structures</a>	Nenad Gubelj
<a href="#">2.4 Laboratory for Materials Handling Systems and Logistics</a>	Tone Lerher
<a href="#">2.5 Laboratory for Welding</a>	Tomaž Vuherer
<a href="#">2.6. Laboratory for Structural Evaluation</a>	Srečko Glodež
<a href="#">2.7 Laboratory for Advanced Computational Engineering and Experimenting</a>	Zoran Ren



*Head of the Chair of Construction and Design*

**Prof. Bojan Dolšak**

E-mail: [bojan.dolsak@um.si](mailto:bojan.dolsak@um.si)

Tel.: +386 2 220 7691, 031 659 301

Web: <https://www.fs.um.si/o-nas/organiziranost/katedre-instituti-centri/katedra-za-konstruiranje-in-oblikovanje/>

### 2.1 LABORATORY FOR INTEGRATED PRODUCT DEVELOPMENT AND CAD IPD CAD LAB



*Head of the Laboratory*

**Prof. Bojan Dolšak**

E-mail: [bojan.dolsak@um.si](mailto:bojan.dolsak@um.si)

Tel.: +386 2 220 7691, 031 659 301

Web: <https://ipd.fs.um.si/>

Our laboratory combines the principles of integrated product development and computer-aided design (CAD), with the vision of becoming a leading centre of innovative research and education in the field of computer-aided design and integrated product development. Our members are experts in various fields, which allows us to optimise the product development cycle, reduce costs, and increase functionality, performance and product safety. We work with academic and industry partners to push boundaries in the field of Integrated Product Development and CAD. In our work, we use the latest software for product development, construction, design, simulation and testing. In addition, we also have advanced hardware and resources to support the product development process, such as 3D scanners and printers, which enable efficient visualisation, analysis of various solutions and their continuous improvement.

### MAJOR RESEARCH EQUIPMENT

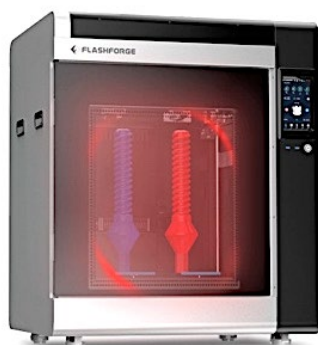

#### **Creator 4 Flashforge Zhejiang Flashforge 3D Technology Co., Ltd., China**

It is a high-performance 3D printer for industrial use. The 3D Flashforge Creator 4, equipped with three different interchangeable extruders, can print with flexible filaments, engineering filaments and carbon fibre composite filaments, which is a good choice for commercial production. The 3D printer allows 3D printing with two different materials at the same time, which also allows for simultaneous printing using supports. The Flashforge Creator 4 offers a 3D printing volume of up to 400 x 350 x 500 mm.

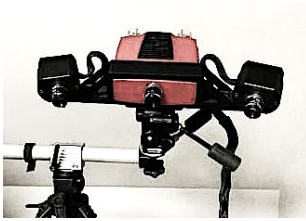

#### Atos 2 400 GOM Gom GmbH, Germany

It is a high-performance 3D optical scanner designed for spatial – 3D scanning of objects (products). The scanner is designed for use in various industrial applications, where we can use three different sized measuring volumes, and thus achieve an accuracy of the scanned model in the size class of 0.02 mm. Typical applications of the scanner are optical 3D metrology, quality control, reverse engineering, spatial visualisation.



#### SLS 2 HP HP Inc., USA

This 3D scanner is used to capture three-dimensional objects and surfaces, and, as a special feature, it offers the possibility of capturing the textures of the surface of objects. The scanner can operate in 6 different volumes and with automatic compilation of scanograms. This device is designed for high-precision (up to 0.05 mm) and fast scanning of objects, which is useful in a variety of industrial and design applications.



#### Mole 3DMakerPro Shenzhen Jimuyida Technology Co., Ltd., China

The Mole enables high-precision 3D scanning of objects with an accuracy of up to 0.05 mm to capture fine details. With a one-time area of 200 x 100 mm and a scan speed of up to 10 FPS, it can scan a medium-sized object quickly. Scanning is carried out using a visual tracking system based on Artificial Intelligence and NIR (Near Infrared) technology, which enables high-quality capture of objects of different colours and textures. The captured 3D scans can be printed in the most used 3D OBJ/STL/PLY file formats, which support immediate use, or further work with the 3D scan.



#### Lynx 3DMakerPro Shenzhen Jimuyida Technology Co., Ltd., China

With 250 x 400 mm single capture and optical image stabilisation and 1 advanced marker-free visual tracking, the Lynx allows you to scan larger objects up to 5000 x 5000 x 5000 mm in size. This 3D scanner provides an accuracy of 0.10 mm and a resolution of 0.30 mm, which allows the creation of accurate and detailed point clouds, thus achieving a high level of reproduction of objects suitable for industrial purposes.

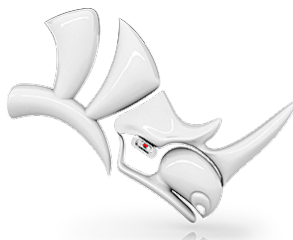

#### Rhinoceros 3D Robert McNeel & Associates, USA

Rhino3D is an advanced programme for surface 3D modelling and design. The programme allows you to model 3D objects and (free) surfaces accurately, create high-quality rendered images and animations, and use the Grasshopper visual programming language to create parametric models. Rino3D version 7 offers a wide range of creative design tools, such as Sub-D modelling tools and polygon model manipulation tools.



**ANSYS Ansys Inc., Canonsburg, Pennsylvania, USA** is a versatile numerical simulation software suite that enables accurate analyses of various mechanical and physical systems in a virtual environment. The programme is one of the leading tools in the field of Simulation of solids, liquids, thermal processes and electromagnetic phenomena. With its advanced features, it enables the performance of a variety of simulations, including static, dynamic, modal, thermal, electromagnetic and many other analyses. In addition, it supports a wide range of material models, allowing for accurate simulations of a variety of real-world materials and complex systems.

#### SERVICE OFFER AND SUPPORT TO THE ECONOMY

In its work the laboratory focuses on finding innovative solutions, and prides itself on its commitment to excellence. Within the laboratory we carry out various development projects for Slovenian companies and thus transfer the results of scientific research to the wider environment. In these projects we often involve students, who gain valuable experience, while the companies gain insight into their competencies. These projects not only



serve to transfer knowledge and find technological solutions but also establish a connection between students and their future working environment. In the implementation of more demanding and extensive development projects, we also connect with other related laboratories at the faculty and thus ensure the integrity of the solutions offered. In two cases, the results of the development projects were also protected by a patent, in which the members of the laboratory are also listed as inventors.

Find out more about how we can overcome your development challenges together. Our range of services and support for the economy includes:

- design and development of innovative products,
- computer-aided design (CAD) and related engineering analyses,
- development of advanced materials based on the desired mechanical response,
- rapid prototyping and 3D printing in the product development process,
- reverse engineering and product analysis,
- optimisation of product design and production processes.

### COOPERATION WITH RESEARCH INSTITUTIONS

- Center for Engineering Software and Dynamic Testing, and Centre for Information Technologies, University of Kragujevac, Kragujevac, Serbia
- Chair of Applied Mechanics, School of Engineering and Design, Technical University of Munich, Munich, Germany
- Department of Mechanical Engineering, Politecnico di Milano, Milano, Italy
- Department of Management, Information and Production, Engineering, University of Bergamo, Italy
- AIST - Advanced Industrial Science and Technology, Tokyo, Japan
- Bioengineering Research Group, Manchester University, Manchester, United Kingdom
- Institute of Sports Medicine, Faculty of Medicine, University of Maribor, Maribor Slovenia
- University Medical Center Maribor, Maribor, Slovenia
- University Rehabilitation Institute of the Republic of Slovenia - Soča, Ljubljana, Slovenia
- Centre for Health and Technology, University of Antwerp, Antwerp, Belgium
- Chair of Design and CAD, Faculty of Engineering, University of Bayreuth, Bayreuth, Germany
- Faculty of Mechanical Engineering, Computer Science and Electrical Engineering, University of Mostar, Mostar, Bosnia and Herzegovina
- Faculty of Mechanical Engineering, University of Sarajevo, Sarajevo, Bosnia and Herzegovina
- Faculty of Mechanical Engineering, University of Zenica, Zenica, Bosnia and Herzegovina

### MOST IMPORTANT RESEARCH ACHIEVEMENT

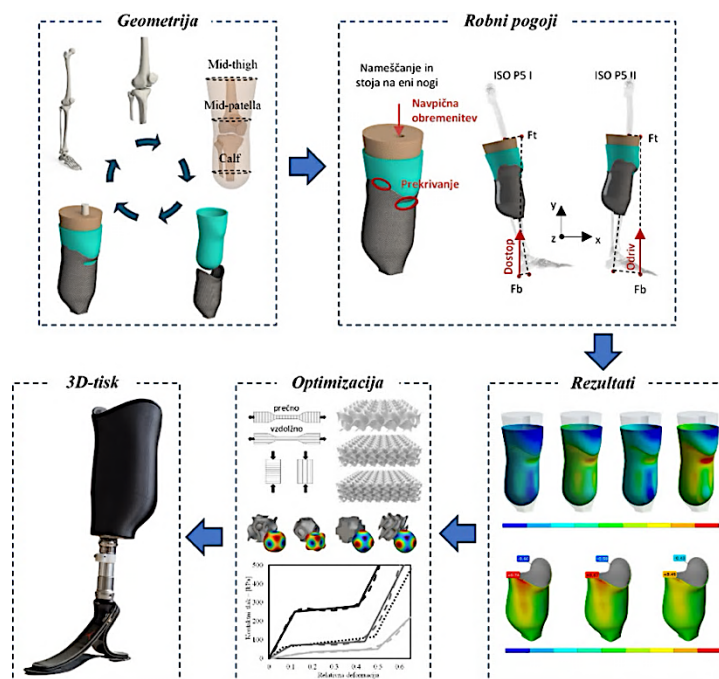

### Computational modelling of a generic transtibial crown for the development of prosthetic sockets and insoles from cellular structures using Additive Technologies.

The developed generic model allows for an objective assessment of numerical results, and a relative comparison of parameters such as contact pressure and deformation, which affect the comfort and stability of the prosthesis significantly during use. Using the finite element method, we can predict the interaction between the crown and the prosthesis in a virtual environment, thus contributing to the development of new materials and shapes of prosthetic mattresses and insoles.

#### COOPERATION WITH COMPANIES

Additio, d.o.o., AddiFlex, d.o.o., LEK, d.d., ELAN, d.o.o., GORENJE, d.d., PIŠEK - Vitli KR PAN, d.o.o., KGS Krajnc, d.o.o., ARCONT, d.d., Modularis TECH, d.o.o., MVA, do.o., SSR-SUB Sarl, Soltec, d.o.o., Irnas, d.o.o., TVT tirna vozila, d.o.o., Hella Saturnus Slovenija, d.o.o., Livar, d.d., Medicop, d.o.o., Talum, d.d., Alpina, d.d., Aplast, d.o.o., Boxmark, d.o.o., Ergonomske rešitve, d.o.o., Farmtech, d.o.o., Prefa, d.o.o., Isokon, d.o.o., Pokrajinski muzej Maribor, Posl, d.o.o., Svit-Zolar, d.o.o.

#### PUBLICATIONS

1. SLAVKOVIĆ, Vukašin, HANŽELIČ, Blaž, PLESEC, Vasja, MILENKOVIĆ, Strahinja, HARIH, Gregor. *Thermo-mechanical behavior and strain rate sensitivity of 3D-printed polylactic acid (PLA) below glass transition temperature (T<sub>g</sub>). Polymers. May 2024, vol. 16, iss. 11, DOI: 10.3390/polym16111526.*
2. PLESEC, Vasja, HARIH, Gregor. *Development of a generic numerical transtibial model for limb-prosthesis system evaluation. Applied sciences. Feb. 2023, vol. 13, iss. 4, str. 19, DOI: 10.3390/app13042339.*
3. HARIH, Gregor, KALC, Miloš, VOGRIN, Matjaž, FODOR-MÜHL DORFER, Marion. *Finite element human hand model: Validation and ergonomic considerations. International journal of industrial ergonomics, Sep. 2021, vol. 85 (103186), str. [1]–8, DOI: 10.1016/j.ergon.2021.103186.*
4. CUPAR, Andrej, KALJUN, Jasmin, DOLŠAK, Bojan, HARIH, Gregor. *3D printed deformable product handle material for improved ergonomics. International journal of industrial ergonomics, March 2021, vol. 82 (103080), str. [1]–7, DOI: 10.1016/j.ergon.2020.103080.*
5. RAY, Tony, KALJUN, Jasmin, STRAŽE, Aleš. *Comparison of the vibration damping of the wood species used for the body of an electric guitar on the vibration response of open strings. Materials, 2021, vol. 14, iss. 18, str. 1–13, DOI: 10.3390/ma14185281.*

#### PATENTS AND PATENT APPLICATIONS

- HUMAR, Jani, KOROŠEC, Albert, GOLJEVŠČEK, Aleksander, GLODEŽ, Srečko, PEHAN, Stanislav. *Vehicle: SI 25951 A, 2021-07-30. Ljubljana: Intellectual Property Office of the Republic of Slovenia, 2021.*
- KRAJNC, Mitja, DOLŠAK, Bojan. *Device and method for emptying the excavation excavation scoop: SI 23107 A, 2011-01-31. Ljubljana: Intellectual Property Office of the Republic of Slovenia, 2011.*

#### ARIS RESEARCH PROGRAMME P2-0063 Design of Cellular Structures

##### NATIONAL AND INTERNATIONAL PROJECTS

- Research on the applicability of stochastic and ordered cell structures at the meso and macro levels in general mechanical engineering. ARIS BI-BA/24-25-021, 2024-2025.
- Development of a numerical model of the human hand for ergonomic product design. Z2-8185, 2012-2019.
- ERGO WORK - Joining academia and business for new opportunities in creating ERGO nomic WORK places. LLP Centralised projects, ERASMUS MP, Knowledge Alliances, 2013–2015.
- Expert system for engineering analyses according to the Finite Element Method. J2-0600, 1998–2001.

#### MEMBERSHIPS

- SLAIS - Slovenian Society for Artificial Intelligence

## 2.2 LABORATORY FOR PRODUCT DESIGN



*Head of the Laboratory*

**Assoc. Prof. Sonja Šterman**

E-mail: [sonja.sterman@um.si](mailto:sonja.sterman@um.si)

Tel.: +386 2 220 7966

Web: <https://www.fs.um.si/laboratorij-za-inzenirsko-oblikovanje/>

The interdisciplinary knowledge of the members spans several areas, including of industrial and customised product design, conceptual and ergonomic design, as well as 3D scanning, 3D printing, and other high-speed manufacturing technologies, from construction to evolution. In the field of Industrial Design we cooperate with various companies, for which we design and model a wide range of objects, perform 3D scanning, reverse engineering and rapid prototyping for various purposes, such as housings for electronic devices, plastic packaging, plastic bottles, design of moulds and tools for plastic bottles, designing car bodies and car parts, bicycles, kitchen and sanitary fittings, architectural prototypes, chairs, shoes and accessories, innovative gadgets, etc. We also collaborate with museums, galleries and other institutions in the preservation of cultural heritage and in the virtual presentation of 3D objects through the digitization of 3D artefacts, such as statues, reliefs and other three-dimensional objects. We are involved in project teams within companies for the development of new products and in the measurement control of large-scale facilities.

### MAJOR RESEARCH EQUIPMENT



#### Light Tents ProPin

Light tents in the form of cubes measuring 60, 80 and 150 cm provide even and soft lighting for photographing products of smaller and larger sizes. The installation is very easy and can also be folded up compactly. The textile material offers a white background. The base features have a rotating bottom for easier movement of the photographed products. In addition to the tents, studio photo lighting is also used.

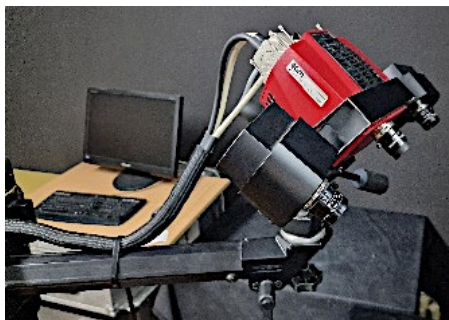

#### Atos II 400 GOM GmbH

The scanner is used for precise 3D scanning of objects. 3D digitisation can also be used as a metrological measurement for the purpose of analysing shape deviations or as a 3D model for further processing, reverse engineering, or object reconstruction. The system supports measuring volumes of 135 mm, 350 mm and 1200 mm, depending on the lens package. It is compatible and complementary to the TRITOP photogrammetric system, which allows the capture of larger objects with greater accuracy and optionally adds a colour texture to the captured object.



#### GOM Tritop Photogrammetric Camera GOM GmbH

TRITOP is a digital 3D photogrammetric camera that enables the 3D digitisation of points in space and of defined lines and edges previously placed on the object. It provides the ATOS system with the basis of 3D spatial reference points, to which ATOS adds 3D scanograms.



#### HP SLS 2 HP

The HP SLS 2 is a 3D scanner used to capture three-dimensional objects and surfaces. A key feature of this scanner is the ability to capture surface textures of objects. The scanner can operate in different volumes and with automatic compilation of scanograms. This device is designed for high-precision (up to 0.05 mm) and fast scanning of objects, making it ideal for a variety of industrial and design applications.





**Lynx 3D scanner A 3DMakerPro** with individual capture of 250 × 400 mm, and optical image stabilisation and advanced visual tracking without markers enables scanning of larger objects up to 5000 x 5000 x 5000 mm in size. The 3D-scanner offers an accuracy of 0.10 mm and a resolution of 0.30 mm, enabling the creation of accurate and detailed point clouds, and thus achieves a high level of object reproduction suitable for industrial purposes.



**Metashape Agisoft** is a software for photogrammetry and the creation of three-dimensional models. The programme allows you to combine multiple images of the same object or area to create accurate digital terrain models, 3D models and textured surfaces. Images can be captured from a variety of sources, such as aerial imagery, satellite photos or camera images. We process and analyse them for various purposes, including geodesy, archaeology, construction, geology and other industries that require accurate 3D modelling from images.



#### **Creality 3D Printer Sermoon D1**

It uses FFF technology. With a working volume of 270 x 250 x 310 mm, it can produce complex objects using PLA, ASA, TPU and PETG plastics.

#### SERVICE OFFER AND SUPPORT TO THE ECONOMY

- Design of serial and unique products for clients
- 3D-Scanning
- 3D printing
- 3D-modelling
- 3D visualisation
- Reverse engineering
- Preservation of cultural heritage

#### COOPERATION WITH RESEARCH AND OTHER INSTITUTIONS

- Maribor Regional Museum, Maribor, Slovenia
- Celje Regional Museum, Celje, Slovenia
- Murska Sobota Regional Museum, Murska Sobota, Slovenia
- University North, Varaždin, Croatia
- Nottingham Trent University, Nottingham School of Art & Design, Nottingham, United Kingdom
- Chair of Design and CAD, Faculty of Engineering, University of Bayreuth, Bayreuth, Germany
- Faculty of Mechanical Engineering, Computer Science and Electrical Engineering, University of Mostar, Mostar, Bosnia and Herzegovina
- Faculty of Mechanical Engineering, University of Sarajevo, Sarajevo, Bosnia and Herzegovina
- Academy of Fine Arts, University of Sarajevo, Sarajevo, Bosnia and Herzegovina
- Faculty of Mechanical Engineering, University of Zenica, Zenica, Bosnia and Herzegovina

#### COOPERATION WITH COMPANIES

Sinch Adria, d.o.o., Ergonomske rešitve, d.o.o., Farmtech, d.o.o., Isocon, d.o.o., Medicop, d.o.o., Alpina, d.d., Boxmark, d.o.o., Prefa, d.o.o., Pokrajinski Muzej Maribor, Svit-Zolar, d.o.o.

### MOST IMPORTANT RESEARCH/ARTISTIC ACHIEVEMENT

When designing for costumers, we collaborated with the development team of Farmtech, d.o.o., and designed a trailer for spreading organic fertilisers.



The medium-class of single and double-axle Superfex spreaders, with a total weight from 6 to 12 tonnes, is designed for the optimal application of all organic fertilisers in agriculture. They are characterised by high efficiency, accuracy and multifunctionality. In the Product Design Laboratory, we designed the exterior, the side lines and rear cover of the trailer. The chassis structure has also been modified, together with the geometry of the longitudinal beam, which, in the new design, allows for easier cleaning and maintenance, while, at the same time, offering greater trailer rigidity and material savings.

### PUBLICATIONS

1. HARIH, Gregor, KALJUN, Jasmin, DOLŠAK, Bojan. Influence of product interface material stiffness on human tactile perception during a grasping task. *Applied sciences*. Sept. 2022, vol. 12, iss. 17 (8867), str. 11, ilustr. ISSN 2076-3417. DOI: 10.3390/app12178867. [COBISS. SI-ID 120501507]
2. RAŠOVIĆ, Nebojša, ČEKIĆ, Ahmet, KALJUN, Jasmin. Design and simulation of the controlled failure of custom-built rigid shaft coupling. *International journal of simulation modelling*. Sept. 2022, vol. 21, no. 3, str. 383–394. ISSN 1726-4529. DOI: 10.2507/IJSIMM21-3-596. [COBISS. SI-ID 120515587]
3. RAY, Tony, KALJUN, Jasmin, DOLŠAK, Bojan. Numerical model application to predict the sound quality of an instrument. *International journal of simulation modelling*. Dec. 2021, vol. 20, no. 4, str. 696–706. ISSN 1726-4529. DOI: 10.2507/IJSIMM20-4-580. [COBISS. SI-ID 89035779]
4. RAY, Tony, KALJUN, Jasmin, STRAŽE, Aleš. Comparison of the vibration damping of the wood species used for the body of an electric guitar on the vibration response of open strings. *Materials*. 2021, vol. 14, iss. 18, str. 1–13, ilustr. ISSN 1996-1944. <https://www.mdpi.com/1996-1944/14/18/5281>, <https://repozitorij.uni-lj.si/lzpisGradiva.php?id=131617>, DOI: 10.3390/ma14185281. [COBISS. SI-ID 76586755]
5. RAY, Tony, KALJUN, Jasmin, ŽVEPLAN, Ervin, STRAŽE, Aleš. Selection of wood based on acoustic properties for the solid body of electric guitar. *Archives of Acoustics*. 2019, vol. 44, no. 1, str. 51–58, ilustr. ISSN 2300-262X. <http://acoustics.ippt.gov.pl/index.php/aa/article/view/2287>. [COBISS. SI-ID 3007113]

### ARIS RESEARCH PROGRAMME

P2-0123 - Clothing Engineering and Textile Materials

P2-0063 - Construction of Cellular Structures

### NATIONAL AND INTERNATIONAL PROJECTS

- Redesigning PPE: enhancing the comfort and safety of healthcare workers wearing isolation gowns to treat patients with COVID-19'. AHRC AH/V015842/1, 1.2.2021 - 31.7.2022.
- ARACNE - Advocating the Role of silk Art and Cultural heritage at the National and European scales. HORIZON-CL2-2022-HERITAGE-01-02, 1.3.2023 - 28.2.2026.
- Research on the applicability of stochastic and ordered cell structures at the meso and macro levels in general Mechanical Engineering. ARIS BI-BA/24-25-021, 2024 - 2025.

## 2.3 LABORATORY FOR MACHINE ELEMENTS AND STRUCTURES

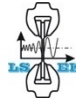

Head of the Laboratory

**Prof. Nenad Gubelj**

E-mail: [nenad.gubelj@um.si](mailto:nenad.gubelj@um.si)

Tel.: +386 2 220 7661

Web: <https://www.fs.um.si/laboratorij-za-strojne-elemente-in-konstrukcije/>

A highly qualified team of experts and the state-of-the-art infrastructure of the laboratory enable the implementation of scientific research and development and professional work in the field of characterisation of mechanical properties and stress-strain behaviour of machine elements, structural components and devices. Among the wide range of goals, we particularly highlight the development of new experimental methods for monitoring material degradation and determining the limit states of components. With this, we want to develop structural components with improved static and dynamic fracture resistance and ensure the safe operation of key structural systems throughout the entire service life. In achieving the set goals, we rely on numerical strength analyses of heterogeneous materials, which are verified experimentally, and we develop methods and systems for monitoring and diagnosing the condition of the material of structures. This represents a feedback loop in the Machine Learning system, and the transfer of Artificial Intelligence to machines and devices. In addition, the laboratory builds and establishes various control systems for the early diagnosis of degradation of the material condition of structural components and develops experimental methods and procedures for the verification and analysis of theoretical and numerical results.

### MAJOR RESEARCH EQUIPMENT



#### HBM 50 Rotech

The HBM 50 is a computer-aided axle, shaft and disc balancing machine weighing up to 50 kg, which enables single- and two-axis shaft balancing in accordance with the ISO 1940-1 Standard.

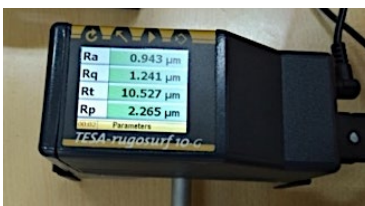

#### ROUGOSURF 10-G TESA

The Rougosurf 10-G is a portable and versatile roughness gauge that can be used in the entrance inspection workshop or in the laboratory. This handheld tool allows you to measure and determine several roughness parameters that can be used in many applications.



#### HARTIP 1500 Bulutmak

The HARTIP 1500 is a portable hardness meter that can be used to measure the hardness on a variety of metallic materials and give results equivalent to HV, HRC and HRB parameters quickly.



#### LEICA TS30 Leica-Geosystems

The Leica TS 30 is a laser measuring system for measuring the coordinates of points in space, which enables accurate measurement of the dimensions of larger structural components over longer distances.





**PULSTEC 360 mm Pulstec Industrial Co., Ltd.**

The Pulstec 360 mm is a device for accurate non-contact measurement of residual stresses on the surface of a material. The device allows you to measure residual stresses on steel, iron, aluminium and aluminium alloys, as well as welded joints.



**ARAMIS 12M Carl Zeiss GOM Metrology GmbH**

The ARAMIS 12M measuring equipment is for stereo-optical monitoring of deformations on the surface of a material. The ARAMIS 12M stereo-optical system enables monitoring of displacement, deformation and tension on the surface of a material during load testing at a recording speed of 25 to 100 frames per second from 12 million measuring points. Based on DIC (Digital Image Correlation) technology, the system performs a fully automatic measurement of displacements and deformations in the observed field from 80 x 60<sup>mm</sup><sup>2</sup> to 910 x 675 mm<sup>2</sup>. The system enables the measurement and analysis of 3D movements of selected discrete points.

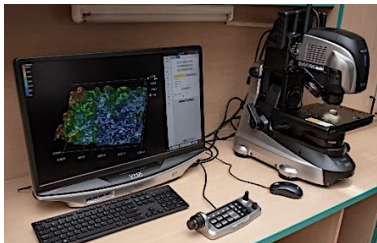

**KEYENCE VHX 7000 Keyence Ltd.**

The Keyence VHX 7000 digital stereo microscope allows synchronisation with other systems, to monitor changes on the surface of a material during testing under load up to x200 magnification, or on a stationary tripod with x 6000 magnification. The samples are examined on a stationary tripod with a motorised x-y coordinate table and a rotating head for automatic magnification changes with lenses and polarising and DIC filters.



**MATELECT DCM 2 MATELECT Ltd UK**

This is a microprocessor instrument for measuring the depth of cracks in metals during loading. It uses the Pulsed Direct Current (DCPD) method, which is already a well-established technique, and is covered by the ASTM 647 Standard. The technique involves passing a constant current through the metal under test, and measuring the resulting voltage drop that occurs on the sample. The presence of an increasing fault will change this tension, and, with proper calibration, a measurement can be obtained of the length of the crack or the depth of the fault.



**OPTOMET Vibrometer Optomet GmbH Darmstadt**

The infrared laser vibrometer is designed to measure vibrations on machine components and devices. It is based on digital infrared shortwave wave technology, with a wavelength of 1550 nm and an output power of 10 mW. Laser shortwave infrared scanning is performed using a Mach-Zehnder interferometer, and data processing based on Field-Programmable Gate Arrays-FPGA in real time. The system generates a signal from a set of predefined functions, or with its own function. The system is capable of live visualisation with 3D animation and vibration visualisation in single-point mode.



**MTS servo-hydraulic machines for single-axis and two-axis testing MTS System USA**

with stand-alone actuators enable static and dynamic testing at low and elevated temperatures on standard and non-standard testers made of various materials and machine components. An MTS system was installed with two free-standing aggregates for ±250 kN and ±100 kN, and two flexible actuators with a capacity of ±100 kN, all with a displacement of ±75 mm, which are attached to a common horizontal platform. The hydraulic power units have lateral hydraulic bearings, which allow testing outside the central axis under additional lateral reaction forces, and, thus, testing components that are clamped spatially in different places.

### SERVICE OFFER AND SUPPORT TO THE ECONOMY

- The laboratory also offers professional support to the economy by carrying out measurements in the laboratory and on machines and structures during operation. The laboratory also develops mechanical systems, machines and devices with appropriate drives and sensors for the needs of the economy.
- Assessment of the integrity of machine components and structures.
- Analysis of the demolition of machinery and equipment.
- Determination of the mechanical behaviour of engineering materials and components subjected to low-cyclic and high-cyclic loads in the range from -40°C to +175 °C temperature.
- Mechanical characterisation of the fracture behaviour of materials according to the ASTM E-647 fatigue Standards, ASTM E-399 fracture toughness testing and ASTM E-1820 resistance curves.
- Design of standard and non-standard tests in accordance with the different needs of clients, and development of new measuring equipment, technology and procedures.
- Development of equipment for monitoring the condition of structures with respect to deformation and vibration behaviour during loading.
- Design of procedures for the inspection and inspection of structures in the event of detected defects or the presence of cracks, in accordance with the ISO and EU procedures and Standards.
- Numerical modelling, optimisation of the topological geometry of devices and components in the field of Medicine, and for general mechanical and structural purposes.
- Non-contact measurements of residual stresses on the surfaces of materials and structural components.

### COOPERATION WITH RESEARCH INSTITUTIONS

- Graz University of Technology, Graz, Austria
- Montanuniversität Leoben, Leoben, Austria
- University of Arizona, Tucson, USA
- University of Ghent, Ghent, Belgium
- Université Paris PSL, Mines Paris, France
- Xidan University, X'ian, China
- University of Zenica, Faculty of Mechanical Engineering, Zenica, Bosnia and Herzegovina
- University of Belgrade, Faculty of Mechanical Engineering, Belgrade, Serbia
- University of Kragujevac, Faculty of Mechanical Engineering, Kragujevac, Serbia
- University of Zagreb, Faculty of Mechanical and Naval Engineering, Zagreb, Croatia
- University of Rijeka, Technical Faculty, Rijeka, Croatia
- University of Mar del Plata, Faculty of Mechanical Engineering, Mar del Plata, Argentina
- University of Stuttgart, Institute of Materials Testing, Stuttgart, Germany
- Budapest University of Technology and Economics-BME, Budapest, Hungary
- University of Ljubljana, Faculty of Mechanical Engineering, Ljubljana, Slovenia
- University of Michoacan, Faculty of Mechanical Engineering, Morelia, Mexico
- Mechanical Engineering Research Institute, Russian Academy of Sciences, Moscow, Russia
- University North-UNIN, Varaždin, Croatia
- Metal core of Međimurje, Čakovac, Croatia
- RMIT Melbourne, Melbourne, Australia
- University of Princeton, Department of Civil and Environmental Eng., Princeton, USA

### COOPERATION WITH COMPANIES

Arcont, d.o.o., Gornja Radgona, C&G, d.o.o., Ljubljana, DEM d.o.o., Maribor, ELAN, d.d., Begunje, ELES, d.o.o., Ljubljana, Farmtech, d.o.o., Ljutomer, GKN, d.o.o., Zreče, Talum, d.d., Kidričevo, Končar, d.o.o., Zagreb, Lagerhof, d.o.o., Podplat, Ledinek Engineering, d.o.o., Hoče, Livarna, d.d., Maribor, Doringer Hytronics, Muta, MR, d.o.o.,

Maribor, Steklarna Rogaška, d.o., Rogaška Slatina, Slovenske železnice, d.o., Ljubljana, Calcit, d.o.o., Kamnik, TCG Unitech, d.o.o., E-inženiring, d.o.o., Ljubljana, Operato, d.o.o., Maribor.

#### MOST IMPORTANT RESEARCH ACHIEVEMENT

##### Procedure for determining fracture mechanical parameters using a ring ( $R \leq 700$ mm).

Together with the Research Institute of Mechanics of the Russian Federation, a procedure for determining the fracture toughness of thin-walled pipe materials was developed and patented, which is used successfully in the reactor technology of nuclear power plants to assess the integrity of pipelines in thermal power plants.

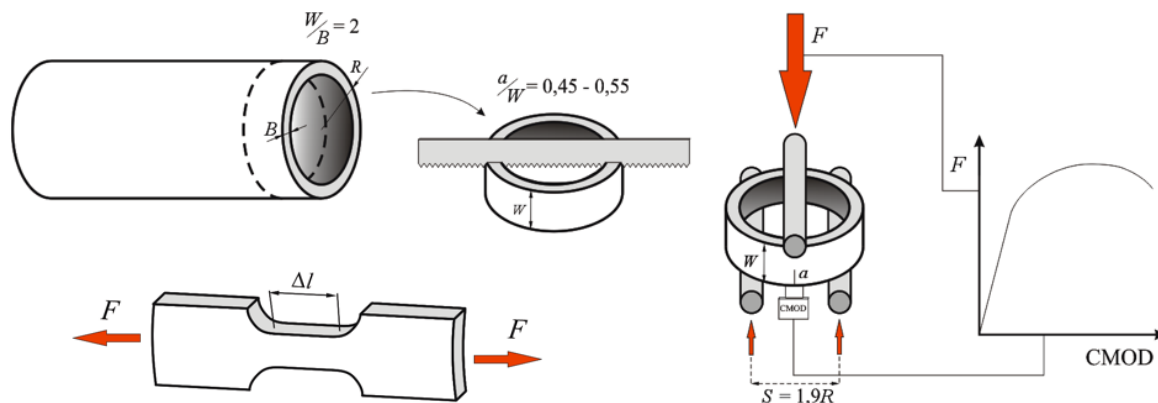

#### PUBLICATIONS

1. FAŠUN, Gašper, CHAPETTI, Mirco Daniel, GUBELJAK, Nenad. *Fatigue integrity analysis of a howitzer cannon by using a fracture mechanics approach. Engineering fracture mechanics. [Print ed.]. Nov. 2023, vol. 292, [article no.] 109672, 13 str. ISSN 0013-7944. DOI:10.1016/j.engfracmech.2023.109672. [COBISS. SI-ID169989891], [JCR, SNIP, Wos, Scopus].*
2. MILKOVIĆ, Marijana, NJEGOVEC, Matej, PREDAN, Jožef, JAVORNIK, Jure, DONLAGIĆ, Denis, GUBELJAK, Nenad. *Monitoring surface state of AA7075-T6 during dynamic loading with FBG sensor. International journal of simulation modelling. Dec. 2023, vol. 22, no. 4, str. 631–642. ISSN 1726-4529. DOI: 10.2507/IJSIMM22-4-663. [COBISS. SI-ID 177641987], [JCR, SNIP].*
3. CHAPETTI, Mirco Daniel, GUBELJAK, Nenad, KOZAK, Dražan. *Intrinsic fatigue limit and the minimum fatigue crack growth threshold. Materials. Sept. 2023, vol. 16, iss. 17, [article no.] 5874, str. 1–20, ilustr., graf. prikazi. ISSN 1996 944 DOI: 10.3390/ma16175874. [COBISS. SI-ID 163221251].*
4. GUAN, Yu, LI, Wei, HUANG, Dongmei, GUBELJAK, Nenad. *A new LBFNN algorithm to solve FPK equations for stochastic dynamical systems under Gaussian or Non-Gaussian excitation: an introduction. Chaos, solitons and fractals. [Print ed.]. August 2023, vol. 173 (113641), str. 12. DOI: 10.1016/j.chaos.2023.113641. [COBISS. SI-ID 155656963].*
5. TOMERLIN, Damir, KOZAK, Dražan, FERLIČ, Luka, GUBELJAK, Nenad. *Experimental and numerical analysis of fracture mechanics behavior of heterogeneous zones in S690QL1 grade high strength steel (HSS) welded joint. Materials. Oct. 2023, vol. 16, iss. 21, [article no.] 6929, str. 31, ilustr. ISSN 1996-944. https://dk.um.si/lzpisGradiva.php?id=86434. [COBISS. SI-ID171432195], [JCR, SNIP, Wos, Scopus].*

#### PATENTS AND PATENT APPLICATIONS

- GUBELJAK, Nenad. Method for determining additional mechanical loads of a transmission power line conductor: European patent specification EP 3 396 348 B1, 2023-05-10. Munich: European Patent Office, 2023. str. 16, ilustr. [COBISS. SI-ID 20704534] patentna družina: EP3396348A1, 2018-10-31; P-201700119, 2017-04-26; SI25126A, 2017-07-31; MA45866A, 2019-06-12.
- MATVIENKO, Yury G., GUBELJAK, Nenad. Model for the definition of truss density: RU 2564696 C1, 10/10/2015. Moscow: Federal'naya služba po intelektualnoj sostvennosti, 2015. Pag. [COBISS. SI-ID 19076630], Patent Family: Russian Patent Application 2014122236/28(036059), 2.6.2014.

ARIS RESEARCH PROGRAMME P2-0137: Numerical and Experimental Analysis of Nonlinear Mechanical Systems

#### NATIONAL AND INTERNATIONAL PROJECTS

- New computer-aided concepts for fracture and fatigue testing and evaluation procedures for multi-material and multi-layer systems. COMET project, 2012-2021.

- Development of techniques for the characterisation of new materials "NoMaTec". COMET project 2022-2026.
- Multiscale Numerical Modelling and Experimental Investigation of Ageing Processes in Sintered Structural »MultiSintAge«. Projekt Croatian Science Foundation, 1.11.2019 - 30.4.2023.

#### MEMBERSHIPS

- ESIS - European Structure Integrity Society
- ASTM - American Standards for Testing Materials
- CIGRE - International Council on Large Electric Systems

#### 2.4 LABORATORY FOR MATERIAL HANDLING SYSTEMS AND LOGISTICS



Head of the Laboratory

**Prof. Tone Lerher**

E-mail: [tone.lerher@um.si](mailto:tone.lerher@um.si)

Tel.: +386 2 220 7725

Web: <https://www.fs.um.si/laboratorij-za-transportne-naprave-sisteme-in-logistiko/>

The Laboratory for Material Handling Systems and Logistics (LTN) operates in the field of development and construction of transport and lifting devices along with warehouse order-picking systems. The focus of the basic research work of the LTN laboratory includes the development of modern analytical and numerical models for the analysis and optimisation of transport, lifting, mobile robotic and warehouse order-picking systems. The industrial (applied) research is focused on the development and construction of prototypes of transport and lifting technology, warehouse order-picking systems, logistic analysis of material flow in intralogistics, the use of sensor systems and the identification and tracking of logistics processes. In our work, we use modern Standards and Technical Regulations, as well as special computer-aided tools that enable the development, modelling, simulation, optimisation and analysis of transport and lifting technology, and warehouse order-picking systems.

#### MAJOR RESEARCH EQUIPMENT

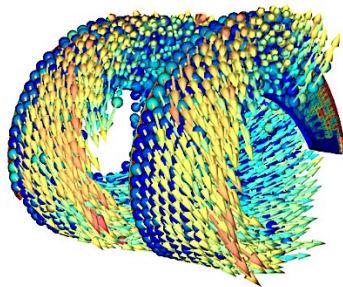

**ANSYS ROCKY Synopsis, Inc.** is a specialised computer-aided tool for the modelling and analysis of the transport of bulk materials and powders and is based on the discrete element method (DEM). With the Ansys Rocky tool, we can precisely study the dependencies and relationships between individual particles that occur in the transport phase. The latter is crucial for understanding particle transport, and increasing the efficiency of transport systems in terms of achieving the required capacity, analysis of mixing processes, measurement of the wear of exposed parts of the conveyor, analysis of resistance during transport, etc.

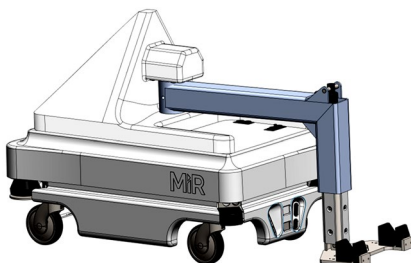

**SOLID WORKS Dassault Systèmes** for the design and modelling of transport and lifting devices is a powerful software tool for computer-aided CAD design. In the LTN laboratory, we use SolidWorks to design various engineering challenges, with an emphasis on modelling conveyor and lifting devices and their systems. SolidWorks is distinguished by several key functionalities, including the ability to model in 3D, the creation of technical drawings and plans, and the implementation of structural analyses of transport and lifting devices.

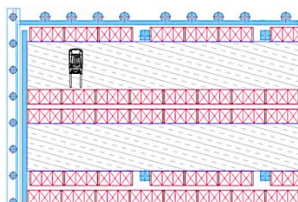

**AUTO CAD Autodesk, Inc.** is a software tool for the design of transport and warehouse order-picking systems that is used in the LTN laboratory for logistic analyses of material flow in the design of transport and storage systems. AutoCAD allows you to display the layout of the production and warehouse system or logistics processes with the precise technical drawings, plans and 3D models.



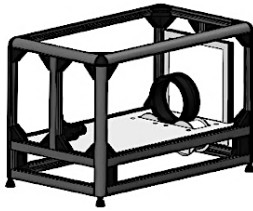

**The device, for the characterisation of powders with a rotating drum,** was manufactured in the LTN laboratory, and is intended for the material characterisation of bulk materials (powders), which includes the analysis of the dynamics of the bulk angle, cohesion index and internal friction. It is used to determine the properties of powders in transportation.

The LTN laboratory also uses its own software and modules, which are developed within the API Application Programming Interface. The latter allows us to customise and improve our tools for optimal performance in specific projects.

#### SERVICE OFFER AND SUPPORT TO THE ECONOMY

- Planning, modelling and optimisation of intralogistics systems.
- Analysis of the material flow of intralogistics systems.
- Numerical simulations of bulk material and powders using the discrete element method DEM.
- Planning and construction of transport and lifting devices and their systems.
- Preparation of expert opinions in the field of Transport and storage systems.

#### COOPERATION WITH RESEARCH INSTITUTIONS

- University of Ljubljana, Ljubljana, Slovenia
- University of Belgrade, Belgrade, Serbia
- University of Zagreb, Zagreb, Croatia
- Cracow University of Technology, Cracow, Poland
- University of West Bohemia, Plzen, Czech Republic
- Tomas Bata University, Zlin, Czech Republic
- Vilnius Gediminas Technical University, Vilna, Lithuania
- Saarland University, Saarbrücken, Germany
- Ingolstadt University of Applied Sciences, Ingolstadt, Germany
- Norwegian University of Science and Technology, Trondheim, Norway
- Yuan Ze University, Taoyuan City, Taiwan
- Texas State University, San Marcos, USA
- North Carolina State University, Raleigh, USA
- Oregon State University, Corvallis, USA
- Cranfield University, Cranfield, United Kingdom
- Granutools, Rue Jean Lambert Defrêne, Promotion, Belgium

#### COOPERATION WITH COMPANIES

ETRA, d.o.o., Štore Steel, d.o.o., Siemens, d.o.o., SICK, d.o.o., Pišek Vitli-Krpan, d.o.o. and other companies in the field of transport and storage systems.

#### MOST IMPORTANT RESEARCH ACHIEVEMENT

##### **A model for predicting the wear and service life of bulk conveyor systems.**

To provide accurate and reliable predictions of the wear of the treated surfaces and the expected service life of the conveyors, we have developed a calibrated numerical model intended for the analysis of various conveyor systems for bulk materials. The numerical model is based on the discrete element method (DEM) and is supported by experimental analyses in terms of calibration and material characterisation of refined surfaces and bulk materials.



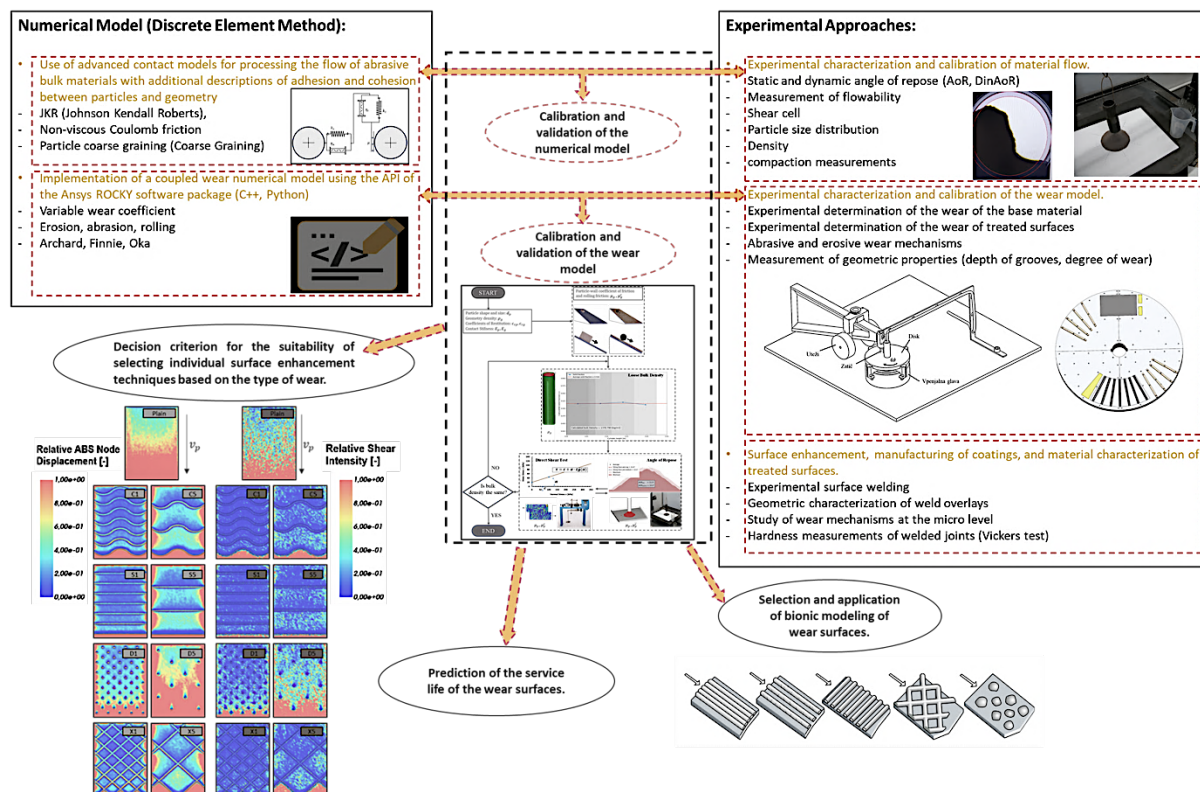

## PUBLICATIONS

1. *MOTALN, Marko, LERHER, Tone. Innovative approaches to wear reduction in horizontal powder screw conveyors: a design of experiments-guided numerical study. Applied sciences. April 2024, vol. 14, iss. 7, [article no.] 3064, str. 24, ilustr. ISSN 2076-3417. DOI: 10.3390/app14073064.*
2. *EKREN, Banu Y., LERHER, Tone, KÜÇÜKYAŞAR, Melis, JERMAN, Boris. Cost and performance comparison of tier-captive SBS/RS with a novel AVS/RS/ML. International Journal of Production Research. 2023, str. 1–15, ilustr. ISSN 0020-7543. DOI: 10.1080/00207543.2023.2199101.*
3. *KOSANIĆ, Nenad, MAROLT, Jakob, ZRNIĆ, Nenad Đ., LERHER, Tone. Travel time model for multiple-deep shuttle-based storage and retrieval systems. International Journal of Production Research. 2023, str. 1–34, ilustr. ISSN 0020-7543. DOI: 10.1080/00207543.2023.2221750.*
4. *HERCOG, Darko, LERHER, Tone, TRUNTIČ, Mitja, TEŽAK, Oto. Design and Implementation of ESP32-Based IoT Devices. Sensors. July 2023, vol. 23, iss. 23, [article no.] 6739, str. 20. ISSN 1424-8220. DOI: 10.3390/s23156739.*
5. *BENČAK, Primož, HERCOG, Darko, LERHER, Tone. Indoor positioning system based on bluetooth low energy technology and a nature-inspired optimization algorithm. Electronics. 2022, vol. 11, iss. 3, str. 1–27, ilustr. ISSN 2079-9292. DOI: 10.3390/electronics11030308.*

## ARIS RESEARCH PROGRAMME P2-0157 Technological Systems for Smart Manufacturing

### NATIONAL AND INTERNATIONAL PROJECTS

- Smart Intralogistics Systems: Integrating Vertical Lift Modules and Shuttle-based Storage and Retrieval Systems. Bilateral SLO-NO research project BI-NO/20-22-012, 2020 - 2022.
- Improving inbound and outbound logistics by using transportation data in supply chain. Bilateral SLO-LT research project BI-LT/20-22-010, 2020 - 2022.

### MEMBERSHIPS

- Slovenian Institute for Standardization SIST - SIST/TC DTN Lifting and Transport Equipment.
- International Professional Society Verein Netzwerk Logistik VNL, Austria.

## 2.5 LABORATORY FOR WELDING



Head of the Laboratory

Assis. Prof. **Tomaž Vuherer, IWE, IWI-c**

E-mail: [tomaz.vuherer@um.si](mailto:tomaz.vuherer@um.si)

Tel.: +386 2 220 7677

Web: <https://www.fs.um.si/laboratorij-za-varjenje/>

The laboratory has excellent research equipment, and special knowledge in the field of testing materials and welded joints, which enables us to carry out scientific research and development activities in the field of welds, materials and welding technologies. Our fundamental focus is on the characterisation of welds and joints, especially metallic, polymer and composite materials. The goals of our research are the design and optimisation of welding technologies, and the achievement of the desired mechanical, technological and metallurgical properties of welded and joined materials throughout the life of the welded joint. Our laboratory specialises in performing various mechanical tests, fracture mechanics, material fatigue and crack growth analysis, which is confirmed by our excellent expertise in the field of material testing and welded joints.

## MAJOR RESEARCH EQUIPMENT

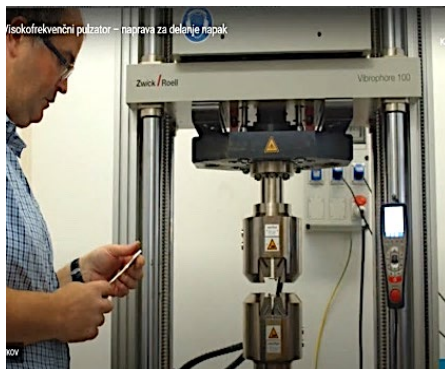

**Vibrophore 100 Zwick** is a resonant tearing machine with a capacity of 100 kN, which is designed for the fatigue of materials, production of S-N curves and Wöhler curves with frequencies up to 100 Hz. Testing can be carried out on tension or bending. By pre-setting the machine, it is possible to perform static tensile, bending and shear tests on it. It is also intended for fracture mechanical tests, to produce cracks before testing, for the performance of fracture mechanical tests and for marking after the fatigue test. The machine is shared with the Structural Evaluation Laboratory.



**Varmig 271-i LCD** (MAG, MIG, FCAW, SMAW); **VARTIG 221 AC/DC** (TIG, SMAW); **VPS 4000** (MAG, MIG, FCAW SMAW); **Welbee 500L** (MAG, MIG, FCAW, SMAW) **Daihen Varstroj**; **AVP A13, Rade Končar 1000 A** (EPP) **AVP**; **Flame Welding & Cutting Kit Messer**. The equipment enables the production of welded joints using REO, MAG, MIG, TIG, EPP, FCAW procedures, as well as cutting of the base material and welds.



**The instrumented Charpy pendulum Amsler RPK 300** with its own Vuhi-Charpy 2024-ver1 program, is intended for an in-depth study of impact testing, where the total fracture energy can be determined, which is divided into crack formation energy and crack propagation energy. Also determined are the behaviour of the material during the fracture itself and the percentage of tough fracture.



**The Amsler 20 t servo hydraulic tearing machine** is designed for static testing of welds and materials. Tensile, compressive, bending and shear tests of welds and materials can be carried out on it. The capacity of the tearing machine is 200 kN, and it has a tensile area and a pressure zone. With the machine's own instrumentation and extensometers it is possible to capture signals directly on the computer. The following are available: - screw fixtures from M6 to M24, round fixtures from  $\text{Æ}2$  to  $\text{Æ}25$  mm and flat fixtures up to 20 x 50 mm.



**The Rumul Cracktronic 160 Nm** is designed to measure crack propagation in material and weld under dynamic loads. The machine is resonant, which allows for rapid cyclic loading of materials with a frequency of up to 100 Hz. It is possible to produce Wöhler and S-N curves for materials and welded joints. It is also intended for the manufacture of cracks for fracture mechanics in the phase of pre-fatigue and in the phase of fatigue of material and welds. **The Rumul Fractomat**, in combination with the Rumul Cracktronic 160 Nm, makes it possible to monitor crack growth under different dynamic loads in materials and welds. This is possible by tearing the foil, which is glued to the material and allows the crack to be measured to 1 mm accurately. With this, it is possible to determine the rate of crack propagation and the Paris curve of how the crack spreads through a particular material or weld. These allow us to predict the remaining service life of a material or component made of that material. The fractomat is portable and can also be used on other machines, such as the Vibrophore 100, or elsewhere in the field to monitor crack growth under dynamic loads.

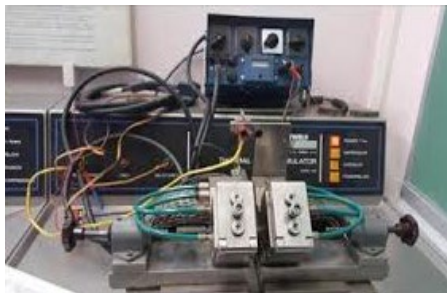

#### **Smitweld Welding Thermal Cycle Simulator 1405 Smitweld**

The welding thermal cycle simulator is an excellent choice to produce microstructures that occur in the heat-affected area, such as the coarse-grained part of the HAZ, the fine-grained part of the HAZ, the inter-critical part of the HAZ and the subcritical part of the HAZ. This allows for a comprehensive study of the individual parts of the HAZ that occur in the weld. It also allows you to simulate the formation of residual stresses resulting from impeded shrinkage during welding.

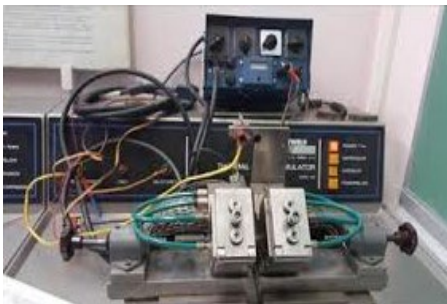

#### **Smitweld 1405 - 10 kN tensile machine Smitweld**

The mechanical tensile machine is designed for static tensile, compressive, bending and shear tests. It can also be used to perform dynamic tests with a low fatigue frequency, so that the test subjects do not heat up during fatigue, and it is also suitable for testing composite materials and plastics. In addition, tensile compressive load cells of 20 N or 200 N can be connected to it, which is suitable for testing samples with a small cross-section. When we connect a CMOD sensor to the machine, we can perform fracture mechanical tests on it.



**The Vishay RS200 Vishay** is designed to measure macro residual stresses on material and welded joints. The system works by measuring micro deformations due to drilling a hole that deforms due to residual stresses present in the material. Measurements are carried out with a three-element resistive measuring rosette, which is glued to the material. With the help of three Wheatstone bridges that measure deformations in individual strain gauges, deformations can be measured, and the released residual stresses can be calculated. We get the principal residual stresses and the angle of orientation of the principal residual stresses with respect to the position of the measuring rosette.





**The Zwick rotary bending machine UBM-200** is designed for dynamic loading with rotary bending for determining S-N and Wöhler curves on materials. It can operate in displacement control or in force control at frequencies up to 85 Hz. It can be used to test materials for fatigue and predict the service life or remaining service life of materials, components and welds. The machine can handle loads of up to 200 Nm. On the machine, we can produce a fatigue crack on the test pieces of round shapes with a pre-prepared notch. Then, the specimens are used for fracture mechanics.



**Wild M10 Leica Stereo Optical Microscope Leica**

It allows you to observe and measure cracks that occur in the material, or when the material is fatigued. It is indispensable in the measurement of crack shape, in the evaluation of fracture-mechanical tests, where the shape and front of the fatigue crack and the crack propagation in the fracture-mechanical test are measured on the fractured surfaces of the specimen. It allows magnifications of up to 200x with different angles of exposure.



**Shimadzu Hardness Meters HMV-2000 Shimadzu**

They are designed for semi-automatic hardness measurements according to Vickers, Brinell and Rockwell. The Shimadzu HMV-2000 hardness meter allows you to measure hardness and microhardness according to Vickers with a load of 2 g to 2 kg on the material, or in various microstructures of the welded joint. The microscope has a hardness meter that allows magnifications of 100x and 500x. **Zwick 3202 Hardness testers Zwick** is also designed to measure hardness according to Vickers and Brinell, where it is possible to measure hardness with weights up to 10 kg. The portable kraut gauge is designed for field hardness measurements using the Vickers and Rockwell method.



**Measurement System National instruments**

It is designed to capture deformation signals from resistive gauge sheets, to measure force, displacements, accelerations and pressures on various machines during operation and testing. It is also possible to transfer the equipment to the field and carry out measurements of various quantities there. A data acquisition speed is possible up to 2 M/s. The equipment consists of various modules – an SCXI 1000 housing, SCXI1100 voltage + thermocouples, an SCXI 1520 Wheatstone bridge amplifier, SCXI 1314, SCXI terminal blocks, and several data capture cards with different data capture speeds with additional sensors.

**SERVICE OFFER AND SUPPORT TO THE ECONOMY**

The welding laboratory offers support to companies at various levels:



- at the level of design and planning of welding technology,
- at the level of standard mechanical tests of welds and materials,
- at the level of dynamic testing of welded joints and materials,
- at the level of special technological tests of welded joints and materials,
- at the level of special examinations of materials and welds.

- Consulting in the creation of WPQR, WPS, welding plans and non-destructive investigation plans.
- In the laboratory it is possible to perform test welds with various welding procedures, such as: SMAW, TIG, MIG, MAG, SAW and spot resistance welding, thus optimising the welding processes.
- Mechanical testing of welded joints and materials (tensile test, bending test, instrumented impact toughness test, hardness measurements).

- Various technological testing of welded joints and materials.
- Dynamic testing of welded joints and materials, S-N curves, Vöhler curves.
- Measurement of the growth rate of cracks, Paris curves.
- Fracture mechanics on welded joints and materials.
- Simulations of TVP material on a welding thermal cycle simulator.
- Heat treatment of small, welded joints and materials.
- Measurements of residual stresses on welds, materials and structures.
- Monitoring of deformations and stresses during the operation of structures with resistive gauge strips.
- Analysis of various damages in the operation of structures.
- Integrity of welded joints and prediction of service life and remaining service life of structures in operation or damaged structures.

#### COOPERATION WITH RESEARCH AND OTHER INSTITUTIONS

- MAGNA STEYR - Aerospace, Graz, Austria
- The Boeing Company, Arlington, USA
- NASA, The National Aeronautics and Space Administration, Washington, D.C., USA
- ESA, European Space Agency, Paris, France
- Research and Testing Institute Plzen Ltd., Plzen, Czech Republic
- Metallurgical Institute of Serbia, Belgrade, Serbia
- Military Technical Institute Belgrade, Belgrade, Serbia
- Institute of Welding, Ljubljana, Slovenia
- Mining Institute Tuzla, Tuzla, Bosnia and Herzegovina
- University of Ljubljana, Faculty of Mechanical Engineering, Ljubljana, Slovenia
- Graz University of Technology, Graz, Austria
- Ternopil Ivan Puluj National Technical University, Ternopil, Ukraine
- Military University of Technology in Warsaw, Warsaw, Poland
- University of Zagreb, Faculty of Mechanical Engineering and Naval Engineering, Zagreb, Croatia
- University of Slavonski Brod, Slavonski Brod, Croatia
- University of Belgrade, Faculty of Mechanical Engineering, Belgrade, Serbia
- University of Belgrade, Faculty of Technology and Metallurgy, Belgrade, Serbia
- University of Niš, Faculty of Mechanical Engineering, Niš, Serbia
- University of Novi Sad, Novi Sad, Serbia
- Cyril and Methodius University of Skopje, Faculty of Mechanical Engineering, Skopje, North Macedonia
- University of Sarajevo, Faculty of Mechanical Engineering, Sarajevo, Bosnia and Herzegovina
- Djemal Bijedić University, Faculty of Mechanical Engineering, Mostar, Bosnia and Herzegovina
- University of Mostar, Faculty of Mechanical Engineering, Mostar, Bosnia and Herzegovina
- University of East Sarajevo, Faculty of Mechanical Engineering, Sarajevo, Bosnia and Herzegovina
- University of Montenegro, Faculty of Mechanical Engineering, Podgorica, Montenegro
- Faculty of Polymer Technology, Slovenj Gradec, Slovenia

#### COOPERATION WITH COMPANIES

ADK, d.o.o., Palfinger, d.o.o., Palfinger Marine, d.o.o., Maribor, Magna Steer Areosper, Lestro-Ledinek, d.o.o., Daihen Varstroj, d.d., Institut for welding, d.o.o., Ljubljana, Martmetal, d.o.o., Siege Acroni, D. O., Sij Acroni, d.o.o., Sij Ravne Systems, d.o.o., Sij Metal Ravne, d.o.o., ŠTORE STEEL, d.o.o., Valji, d.o.o., Valji Group, d.o.o., Talum, d.d., Kidričevo, Talum Rondelisce, d.o.o., Impol-Montal, d.o.o., Metalna-SRM, d.o.o., Ferokotao, d.o.o., Armature, d.o.o., Fibmarkt, d.o.o., Premgovnik Valenje, d.o.o., Kolding, d.o.o., Kovinarstvo Bučar, d.o.o., Ecom Ruše, d.o.o., Weld, d.o.o., Electroda Zagreb, d.d., Meser Slovenija, d.o.o., ABVT, d.o.o., IPRO ING, d.o.o., Ingvar, d.o.o., Metal Mikulić, d.o.o., Vers, d.o.o., Urmat, d.o.o., JosS, d.o.o.

## MOST IMPORTANT RESEARCH ACHIEVEMENT

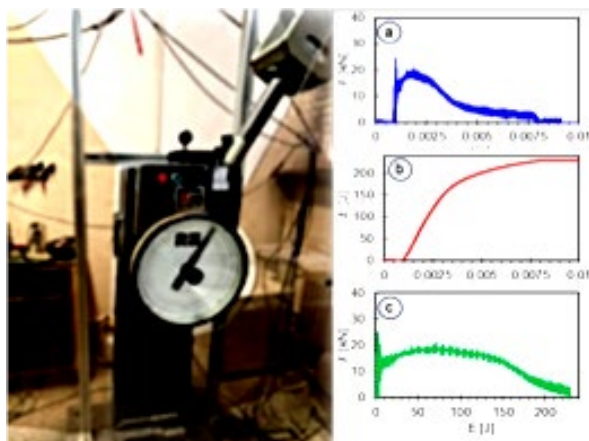

We have instrumented the Charpy Hammer in-house, **which enables force monitoring during fracture and energy monitoring during fracture.** With the help of a magnetic sensor, the total energy for refraction can be divided into the energy for refraction, the energy for initiation and the energy for the propagation of refraction. It is also possible to determine the moment when the crack is initiated from the mechanical notch. Capture occurs at a frequency of  $4 \times 10^6$  data per second. The data, however, are processed in a self-developed Vuhi – Charpy program. The data in the instrumented Charpy test shall be used on heterogeneous materials, such as welded joints, and materials for military purposes. They also use our program for military purposes at home and abroad. The results obtained from the Charpy hammer experiment are used for research purposes, where quite a few publications have been published.

## PUBLICATIONS

1. VUHERER, Tomaž, SMAILI, Fidan, BJELAJAC, Edvard, MANJGO, Mirza, LOJEN, Gorazd. *Simulation and mechanical properties of fine-grained heat-affected zone microstructure in 18CrNiMo7-6 steel*. *Materials*. Sept. 2022, vol. 15, iss. 19 (6782), str. 1–14. ISSN 1996-1944. DOI: 10.3390/ma15196782. [COBISS. SI-ID 125181699]
2. VUHERER, Tomaž, MILČIĆ, Miodrag, GLODEŽ, Srećko, MILČIĆ, Dragan, RADOVIĆ, L., KRAMBERGER, Janez. *Fatigue and fracture behaviour of Friction Stir Welded AA-2024-T351 joints*. *Theoretical and Applied Fracture Mechanics*. Aug. 2021, vol. 114 (103027), str. 1–13. ISSN 0167-8442. DOI: 10.1016/j.tafmec.2021.103027. [COBISS. SI-ID 66873603]
3. LOJEN, Gorazd, VUHERER, Tomaž. *Optimization of PWHT of simulated HAZ subzones in P91 steel with respect to hardness and impact toughness*. *Metals*. Sep. 2020, vol. 10, iss. 9, str. 1–21. ISSN 2075-4701. <https://www.mdpi.com/2075-4701/10/9/1215>, DOI: 10.3390/met10091215. [COBISS. SI-ID 27833603]
4. BJELAJAC, Edvard, SKUMAVC, Andrej, SMAILI, Fidan, LOJEN, Gorazd, PREDAN, Jožef, VUHERER, Tomaž. *Experimental study of crack propagation through clad 316L/355 steel produced by the hot-roll bonding process*. *Metals*. July 2023, vol. 13, iss. 7, 1273, str. 18, ilustr. ISSN 2075-4701. DOI: 10.3390/met13071273. [COBISS. SI-ID 161158403]
5. MILOVIĆ, Ljubica, PETROVSKI, Blagoj, VUHERER, Tomaž. *Estimation of residual strength of a crack-containing welded pressure vessel exposed to a subzero operating temperature*. *Engineering failure analysis*. 2019, vol. 106 (104167), str. 1–9. ISSN 1350-6307. DOI: 10.1016/j.engfailanal.2019.104167. [COBISS. SI-ID 23001622]

## ARIS RESEARCH PROGRAMME P2-0120 Technologies of Metastable Materials

### NATIONAL AND INTERNATIONAL PROJECTS

- The influence of temperature conditions on the microstructure and mechanical properties of additively manufactured materials. N2-0328, ARIS, 2012-2027.
- Structural and surface properties of fibre membranes for purification and chromatographic separation of biomacromolecules. J2-1719, ARIS, 2012-2020.
- The influence of different heterogeneous properties on the structural integrity of the weld with error. N2-0030, 2012-2018.
- Investigation of the influence of the injection site and the effect of glass fibres on the mechanical behaviour of a composite polymer structure produced by injection moulding. A bilateral project with Bosnia and Herzegovina BI-BA/24-25-021) ARIS, 2024-2025.
- Ensuring the integrity of ATIG welded joints on active powder welded austenitic ferritic duplex steels. A bilateral project with Montenegro BI-ME/23-24-019 ARIS, 2023-2024.
- Determination of toughness and fatigue strength properties of new adaptively built materials in welds and heat-affected areas. A bilateral project with Austria BI-AT/18-19-016, ARIS, 2018-2019.
- The problem of residual stresses on structures in the power industry. BI-BA/19-20-036, ARIS, 2012-2021.



- Optimisation of injection moulded plastic components from the point of view of fracture mechanics, a bilateral project with Bosnia and Herzegovina. BI-BA/16-17-011, ARIS, 2012-2017.
- Electro arc TIG and plasma welding of high-alloy Cr-Ni austenitic steels and cast steels using active fluxes. A bilateral project with Montenegro BI-ME/16-17-013, ARIS, 2016-2017.
- Ensuring the integrity of dynamically loaded welded structures made of modern high-strength steels. A bilateral project with Russia BI-RU/19-20-037, ARIS, 2019-2020.
- Ensuring high reliability of aluminium structures and their parts in transport technology. A bilateral project with Serbia BI-RS/20-21-041, ARIS, 2020-2021.
- Research and application confidential projects for the space industry in the field of Production and testing of parts for manned space rockets - cooperation in projects with MAGNA Steyr, aerospace (Austria), The BOEING COMPANY (USA), The National Aeronautics and Space Administration - NASA (USA) and the European Space Agency - ESA (Europe), Project 2391319 + 2391484, Project 2399284, Project 2402695 + 2403276, Project 2412289

#### MEMBERSHIPS

- IIW - International Institute of Welding
- ESIS - European Structure Integrity Society
- ASTM - American Standards for Testing Materials
- SIST - Slovenian Institute for Standardisation
- Welding Technology Society Maribor

#### 2.6 LABORATORY FOR THE EVALUATION OF STRUCTURES



*Head of the Laboratory*

**Prof. Srečko Glodež**

*E-mail: [srecko.glodez@um.si](mailto:srecko.glodez@um.si)*

*Tel: +386 2 220 7708*

*Web: <https://lavkon.fs.um.si/>*

The Laboratory for Structural Evaluation operates under the Chair of Construction and Design at the Faculty of Mechanical Engineering, University of Maribor. The well-equipped laboratory enables research activities in the framework of the following research topics: Dimensioning of dynamically loaded machine parts and structures (HCF, LCF, Fracture mechanics), Computational modelling (structural analysis using the Finite Element Method), Machine elements (in general), Drives (gear drives), Contact problems and tribology and Noise and vibration analyses.

#### MAJOR RESEARCH EQUIPMENT



##### High frequency pulsator Vibrophore 100 ZwickRoel

The testing machine Vibrophore 100 is applicable for static tensile/compression/bending tests and dynamic High Cycle Fatigue tests using flat and round specimens. The main characteristics of the machine are as follows: Force range: up to 100 kN, Test frequency: up to 200 Hz, Set of jaws for round specimens:  $\varnothing 4 \dots \varnothing 17$  mm, Set of jaws for a flat specimen: 0...10 mm. The testing machine Vibrophore 100 can also be used for determination of fracture toughness  $K_{Ic}$  of different engineering materials. Monitoring the fatigue crack growth and determination of the material parameters of the Paris Equation.



#### Electrodynamic Testing Machine LTM3 ZwickRoel

The testing machine LTM3 is applicable for static tensile/ compression/ bending tests and dynamic High Cycle and Low Cycle Fatigue tests using flat and round specimens of small dimensions. The machine is suitable mainly for testing materials often used for lightweight design (Al-alloys, polymers, composites, etc.). The main characteristics of the machine are as follows: Force range: up to 3 kN, Test frequency: up to 100 Hz, Set of jaws for round specimens:  $\varnothing 2.5 \dots \varnothing 12$  mm, Set of jaws for a flat specimen: 0...12 mm. The testing machine LTM3 can also be used for some fracture mechanics testing.



#### Temperature Chamber for Testing Materials ZwickRoel

The temperature chamber is applicable for material testing in the temperature range from  $- 80^{\circ}\text{C}$  to  $+ 250^{\circ}\text{C}$ . A high degree of accuracy in maintaining the desired temperature ensures reliable experimental results. The chamber allows materials to be tested in extreme temperature conditions, such as cold environments or high temperatures, which are crucial in specific applications.



#### IMV vibration test system i220/SA1HAG

The vibration test system is suitable for experimental testing of small engineering components to obtain the vibration behaviour of such components. The main characteristics of the system are as follows: Max. Force: 16 kN, Frequency range: up to 3300 Hz, Max. Acceleration: up to  $1000 \text{ m/s}^2$ .



#### Compact Gear Testing Bench

The test bench is useful for testing cylindrical gear pairs made of various engineering materials (metals, sintered materials, polymers). The experimental testing is focused mainly on the wear behaviour of the analysed gears under different operating conditions (lubricated contact, dry contact, different rotational speeds, etc.).

#### SERVICE OFFER AND SUPPORT TO THE ECONOMY

- Mechanical characterisation of metallic, polymer and composite materials. The experimental testing includes static and dynamic testing of materials and components.
- Performing static and dynamic strength analyses according to the Finite Element Method.
- Vibration measurement of machinery and equipment and basic noise measurements.
- Constructing the drivers of various implementations and elements of transmissions.
- Advanced computational modelling and construction.

#### COOPERATION WITH RESEARCH AND OTHER INSTITUTIONS

- Technische Universität Graz, Graz, Austria
- Institute of Thermomechanics, Czech Academy of Sciences, Prague, Czech Republic
- Montanuniversität Leoben, Leoben, Austria

- University of Belgrade, Belgrade, Serbia
- University of Niš, Niš, Serbia
- University of Zagreb, Zagreb, Croatia
- University of Split, Split, Croatia
- University of Chicago, Chicago, USA

### COOPERATION WITH COMPANIES

Paloma, d.d., Surovina, d.o.o., Calcit, d.o.o., Deutz Engineering, d.o.o, Rotis, d.o.o., Farmech, d.o.o., Talum, d.d., AVL, Domel, d.o.o., Kolding, d.o.o., Mahle, d.o.o., RTC, d.o.o., SPC, d.o.o., Supra, d.o.o., Danfoss, d.o.o., Gea Vipoli, d.o.o., TBP, d.o.o., Container, do. o., Tial, d.o.o., Medicop, d.o.o., Podkrižnik, d.o.o., Roto, d.o.o., Metalna SMM, d.o.o., Dravske elektrarne, d.o.o., SIJ Ravne, d.o.o., Megametal, d.o.o., ...

### MOST IMPORTANT RESEARCH ACHIEVEMENT

**A numerical model for the virtual insertion of vascular splints** was developed as part of international cooperation with the University of Chicago. Computer simulations of the insertion of vascular splints can make an important contribution to the safety and efficiency of intravascular procedures.

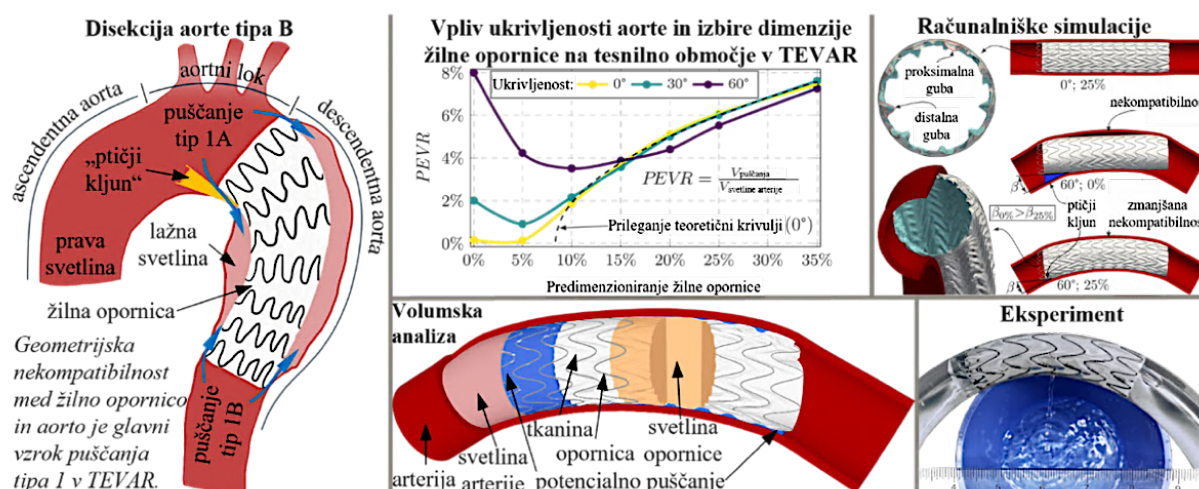

### PUBLICATIONS

- ZUPANIČ, Franc, KLEMENC, Jernej, STEINACHER, Matej, GLODEŽ, Srečko. Microstructure, mechanical properties and fatigue behaviour of a new high-strength aluminium alloy AA 6086. *Journal of alloys and compounds*. [Print ed.]. April 2023, vol. 941, [article no.] 168976, str. 13. ISSN 0925-8388. <https://repozitorij.uni-lj.si/IzpisGradiva.php?id=148321>, DOI: 10.1016/j.jallcom.2023.168976.
- NEČEMER, Branko, ZUPANIČ, Franc, VUHERER, Tomaž, GLODEŽ, Srečko. High-cycle fatigue behaviour of the aluminium alloy 5083-H111. *Material*. Mar. 2023, vol. 16, iss. 7, [article no.] 2674, p. 15. ISSN 1996-1944. DOI: 10.3390/ma16072674.
- POLANEC, Brigita, GLODEŽ, Srečko, BELŠAK, Aleš. Noise evaluation of coated polymer gears. *Polymers*. Feb. 2023, vol. 15, iss. 3, [article no.] 783, str. 22. ISSN 2073-4360. <https://www.mdpi.com/2073-4360/15/3/783>, DOI: 10.3390/polym15030783.
- DONIK, Žiga, NEČEMER, Branko, GLODEŽ, Srečko, KRAMBERGER, Janez. Finite element analysis of the mechanical performance of a two-layer polymer composite stent structure. *Engineering failure analysis*. July 2022, vol. 137 (106267), str. 17. ISSN 1350-6307. DOI: 10.1016/j.engfailanal.2022.106267.
- IGNATIJEV, Aljaž, NEČEMER, Branko, KRAMBERGER, Janez, GLODEŽ, Srečko. Fatigue crack initiation and propagation in a PM-gear tooth root. *Engineering failure analysis*. Aug. 2022, vol. 138 (106355), str. 10. ISSN 1350-6307. DOI: 10.1016/j.engfailanal.2022.106355.

### PATENTS AND PATENT APPLICATIONS

- HUMAR, Jani, KOROŠEC, Albert, GOLJEVŠČEK, Aleksander, GLODEŽ, Srečko, PEHAN, Stanislav. Vehicle: Patent SI 25951 A, 2021-07-30. Ljubljana: Intellectual Property Office of the Republic of Slovenia, 2021.

- ŠAFARIČ, Riko, KRAMBERGER, Janez, ŠORGO, Andrej, EKART, Janez, BRATINA, Božidar, KROŠLIN, Tadej, ŽILIČ FIŠER, Suzana, GÖNCZ, Péter, TAŠNER, Frančišek, TRČEK, Janja, KRAVANJA, Zdravko, BRUMEC, Vilijana, FIŠER, Jure. Process for drying municipal and industrial sludge: Patent: SI24964 (A), 2016-10-28. Ljubljana: Intellectual Property Office of the Republic of Slovenia, 2016.
- KNEZ, Marko, GLODEŽ, Srečko, KRAMBERGER, Janez. Device for determining the parameters of small-cyclic fatigue by means of a rotating bending test: Patent No. 22766 of 02.11.2009, patent application No. P-200800075, dated 1.4.2008. Ljubljana: Ministry of Economy, Intellectual Property Office of the Republic of Slovenia, 2009.

ARIS RESEARCH PROGRAMME P2-0063 Design of Cellular Structures

#### NATIONAL AND INTERNATIONAL PROJECTS

- Development of advanced metamaterials with improved resistance to vibrational fatigue. Z2-50082, 1.10.2023 - 30.9.2025.
- Experimental and numerical analysis of static and dynamic bending loading of composites with a rubber matrix. N2-0326, 1.10.2023 - 30.09.2026.
- Development and mechanical characterisation of metamaterials for lightweight structures, a bilateral project with TU Graz 2023 - 2024.
- Development and mechanical characterisation of an advanced biodegradable vascular splint, a bilateral project with the University of Chicago, USA, 2022 - 2024.

#### MEMBERSHIPS

- Slovenian Society of Mechanics
- Slovenian Society for Tribology
- Membership of the SIST Technical Committees
- ESIS - European Structure Integrity Society

## 2.7 LABORATORY FOR ADVANCED COMPUTATIONAL ENGINEERING AND EXPERIMENTING LACE-X



*Head of the Laboratory*

**Prof. Zoran Ren**

*E-mail: [zoran.ren@um.si](mailto:zoran.ren@um.si)*

*Tel.: +386 2 220 7702*

*Web: <http://lace.fs.um.si/>*

The laboratory specializes in cutting-edge research and development of advanced metamaterials engineered for superior mechanical performance, particularly under extreme conditions such as high-speed impacts, explosions, or collisions. We focus on designing novel metamaterials with cellular internal structures, combining state-of-the-art mathematical and computational modelling with the unparalleled computational power of high-performance supercomputers to optimise their properties.



*Computer simulation of a 38-ton truck hitting a road safety fence*



*Graded TPMS Cellular Metamaterial*



After developing and validating virtual models of these materials, we collaborate with leading domestic and international partners to bring these designs to life using the latest fabrication technologies. These prototypes are then rigorously tested and characterised in our facilities using advanced experimental techniques. This process helps verify their performance for specific applications or identify areas for refinement. In addition to material testing, we specialise in the geometric analysis of internal structures and the development of sophisticated numerical models and simulations to predict material behaviour under extreme loads. Our cutting-edge testing equipment, including the Split-Hopkinson Pressure Bar and Direct-Impact Hopkinson Bar, allows us to precisely measure material properties at high and ultra-high strain rates. Our work has significant applications across various industries, with expertise in developing high-performance materials for road safety systems. By combining deep scientific expertise with innovative technology and strong partnerships, we deliver solutions that meet the most demanding challenges in material science and engineering. If you're seeking a research partner or are interested in our capabilities, we'd be delighted to collaborate with you.

### MAJOR RESEARCH EQUIPMENT



**HPC CORE@UM** is a micro supercomputer with 3 TERAFLIPS of computing capacity, designed to perform complex scientific computer simulations. The installed software enables the implementation of complex nonlinear simulations of the behaviour of solids and liquids and multiphysical problems for a wide range of research and industrial applications.



#### SHPB and DIHB – in-house prototype testing facility

The Split Hopkinson Pressure Bar (SHPB) and Direct Impact Hopkinson Bar (DIHB) test facility is used for experimental testing of engineering materials at high deformation rates between 100 to 8,000  $s^{-1}$ . The maximum diameter of test sample is 20 mm.



#### Mobile system for synchronised fast digital recording of transients - in-house configuration

The system is designed for advanced digital visualisation of extremely fast transient events, such as material impact deformation, vortex formation, cavitation, splashing, brittle fractures, rapid crack propagation, explosions, and projectile effects. It enables a deeper understanding of the fundamental physical principles underlying these phenomena. At the heart of the system are two ultra-fast cameras, the PHOTRON FASTCAM-SA-Z-2100K-M-128GB, capable of capturing up to 2

million frames per second, along with the high-speed DEWESoft SIRIUSi HS 8x STG+ data acquisition system and LED lighting. Complementing these is our proprietary DIC (Digital Image Correlation) analysis software, making this system a comprehensive and powerful tool for investigating high-speed dynamic events.

### SERVICE OFFER AND SUPPORT TO THE ECONOMY

- Design and standard calculations of mechanical structures and mechanisms.
- Static and dynamic computational analyses of linear and nonlinear problems of strength mechanics.
- Geometric characterisation of complex cellular materials and structures.
- Advanced computer modelling of complex engineering phenomena.
- Development and optimisation of cellular metamaterials.

### COOPERATION WITH RESEARCH AND OTHER INSTITUTIONS

- University of Ljubljana, Ljubljana, Slovenia
- University of Zagreb, Zagreb, Croatia
- University of Split, Split, Croatia
- Technical University of Prague, Prague, Czech Republic
- Institute of Theoretical and Applied Mechanics of the Czech Academy of Sciences, Prague, Czech Republic
- Poznan University of Technology, Poznan, Poland
- Helmut Schmidt University, Hamburg, Germany
- Politecnico di Milano, Milan, Italy
- University of Aveiro, Aveiro, Portugal
- Izmir Institute of Technology, Izmir, Turkey
- Middle Eastern Technical University, Ankara, Turkey
- Korea Institute of Machinery and Materials, Daejeon, South Korea
- Waseda University, Tokyo, Japan
- Kumamoto University, Kumamoto, Japan
- National Institute of Technology, Kumamoto College, Kumamoto, Japan
- National Institute of Technology, Okinawa College, Nago, Okinawa, Japan
- The University of Newcastle, Newcastle, Australia
- Beijing Institute of Technology, Beijing, China
- New York University, Abu Dhabi, United Arab Emirates

### COOPERATION WITH COMPANIES

Kveder, d.o.o., Petrič, d.o.o., Liko Liboje, d.d., LOSCO, d.o.o., Gorenje, d.d., KoDUS, s.p., M PLUS, d.o.o., BSH, d.o.o., Nazarje, Container, d.o.o., Danfoss Trata, d.o.o., GEM Motors, d.o.o., Medicop, d.o.o., Aluvar, d.o.o., Nafta Strojna, d.o.o., SACOM, d.o.o., (BIH), Marcegaglia Buildtech (IT), Rimac Technology, d.o.o., (CRO), Unipromet, d. o. o., (SR), Hellenic Pipe Works S.A. (GR).

### MOST IMPORTANT RESEARCH ACHIEVEMENT

**Concept development and optimisation of new metamaterials with a cellular internal structure using advanced mathematical and computational modelling techniques combined with high-performance computing.**

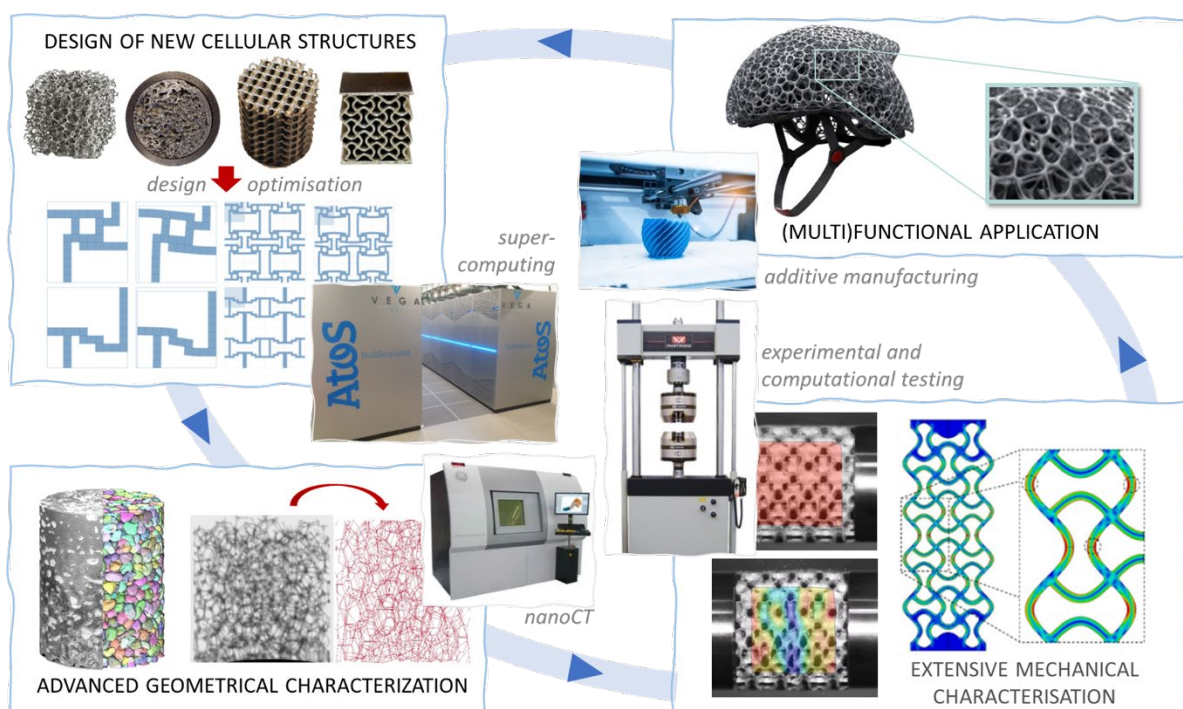



Production of the developed metamaterials using the latest techniques in cooperation with international partners. Comprehensive characterisation of engineered metamaterials using advanced experimental methods to confirm the suitability of their design for specific applications.

## PUBLICATIONS

1. NOVAK, Nejc, AL-KETAN, Oraib, MAUKO, Anja, YILMAZ, Yunus Emre, KRSTULOVIĆ-OPARA, Lovre, TANAKA, Shigeru, HOKAMOTO, Kazuyuki, ROWSHAN, Reza, ABU AL-RUB, Rashid K., VESENJAK, Matej, REN, Zoran. *Impact loading of additively manufactured metallic stochastic sheet-based cellular material. International Journal of Impact Engineering. [Print ed.]. April 2023, vol. 174, [article no.] 104527, str. 1–15. ISSN 0734-743X. DOI: 10.1016/j.ijimpeng.2023.104527.*
2. MAUKO, Anja, SARIKAYA, Mustafa, GÜDEN, Mustafa, DUARTE, Isabel, BOROVIŃEK, Matej, VESENJAK, Matej, REN, Zoran. *High strain-rate deformation analysis of open-cell aluminium foam. Journal of Materials Research and Technology. July-August 2023, vol. 25, str. 1208-1221, ilustr. ISSN 2238-7854.*
3. NOVAK, Nejc, TANAKA, Shigeru, HOKAMOTO, Kazuyuki, MAUKO, Anja, YILMAZ, Yunus Emre, AL-KETAN, Oraib, VESENJAK, Matej, REN, Zoran. *High strain rate mechanical behaviour of uniform and hybrid metallic TPMS cellular structures. Thin-walled structures. Oct. 2023, vol. 191, str. 13. ISSN 0263-8231. DOI: 10.1016/j.tws.2023.111109.*
4. NOVAK, Nejc, BIASETTO, Lisa, REBESAN, Pietro, ZANINI, Filippo, CARMIGNATO, Simone, KRSTULOVIĆ-OPARA, Lovre, VESENJAK, Matej, REN, Zoran. *Experimental and computational evaluation of tensile properties of additively manufactured hexa- and tetrachiral auxetic cellular structures. Additive manufacturing. [Print ed.]. Sep. 2021, vol. 45, str. [1]-18, ilustr. ISSN 2214-8604. DOI: 10.1016/j.addma.2021.102022.*
5. NOVAK, Nejc, AL-KETAN, Oraib, KRSTULOVIĆ-OPARA, Lovre, ROWSHAN, Reza, ABU AL-RUB, Rashid K., VESENJAK, Matej, REN, Zoran. *Quasi-static and dynamic compressive behaviour of sheet TPMS cellular structures. Composite structures. [Print ed.]. Jun. 2021, vol. 266 (113801), str. 1–10. ISSN 0263-8223. DOI: 10.1016/j.compstruct.2021.113801.*

## PATENTS AND PATENT APPLICATIONS

- VESENJAK, Matej, NOVAK, Nejc, REN, Zoran. Axisymmetric chiral auxetic structure: patent SI 26064 A, 2022-03-31. Ljubljana: Intellectual Property Office of the Republic of Slovenia, 2022.
- VESENJAK, Matej, NOVAK, Nejc, REN, Zoran. Axisymmetric chiral auxetic structure: patent application EP21197296.3, 2021.
- HOKAMOTO, Kazuyuki, OTSUKA, Masahiko, HIDA, Eiji, REN, Zoran, VESENJAK, Matej. Novel manufacturing method of a metal pipe joined body having a complicated hollow structure: JP 6821150 B2, 2021-01-27. [Chiyada-ku Tokyo]: Japan Patent Office, 2021.
- HOKAMOTO, Kazuyuki, OTSUKA, Masahiko, HIDA, Eiji, REN, Zoran, VESENJAK, Matej. Novel manufacturing method of a metal pipe joined body having a complicated hollow structure: JP6856208 B2, 2021-04-07. [Chiyada-ku Tokyo]: Japan Patent Office, 2021.
- BOROVIŃEK, Matej, REN, Zoran. Steel road safety barrier with trapezoidal reinforcement = Stahlstraßenleitplanke mit trapezförmiger Verstärkung = Barrière de sécurité routière en acier avec renforcement trapézoidal: European patent specification EP2813620 B1, 2019-03-27. Munich: European Patent Office, 2019.

## ARIS RESEARCH PROGRAMME P2-0063 Design of Cellular Structures

### NATIONAL AND INTERNATIONAL PROJECTS

- Development and characterisation of advanced auxetic cellular metamaterials. Postdoctoral project Z2-2648, 2012 - 2022.
- Development of multifunctional acoustic cell structures. Basic project J2-8186, 2012-2020.
- Topological optimisation of graded auxetic metamaterials. A bilateral Slovenian - Croatian research project BI-HR/18-19-012, 2012 - 2019.
- Preliminary Analysis of Innovative Aerostructures Spectrum Powered by HPC – PAIAeroS, H2020: FF4EuroHPC, 1.3.2022 - 30.5.2023.
- Study on auxetic structures' behaviour under impact conditions. Fundamental international research project Opening Fund SKLEST, Beijing Institute of Technology, 2017 - 2018.

## MEMBERSHIPS

- SDM - Slovenian Society of Mechanics
- SIST - Slovenian Institute for Standardisation
- VDI - Association of German Engineers
- ASME - American Society of Mechanical Engineers
- IMechEng - Institution of Mechanical Engineers
- IROAST Kumamoto - International Advanced Science and Technology Research Organisation
- GAAM - Society for Applied Mathematics and Mechanics
- Alexander von Humboldt
- NAFEMS - International Association for the Engineering Modelling, Analysis and Simulation Community
- USACM - U.S. National Congress on Computational Mechanics

### 3. MATERIALS AND FORMING

In the field of Materials and Forming, 2 laboratories and 1 centre are active:

LABORATORY:	HEAD:
<a href="#">3.1 Laboratory for Materials</a>	Franc Zupanič
<a href="#">3.2 Laboratory for Materials Forming</a>	Ivan Anžel
<a href="#">3.3 University Centre for Electron Microscopy</a>	Ivan Anžel



Head of the Chair of Materials and Forming

**Prof. Ivan Anžel**

E-mail: [ivan.anzel@um.si](mailto:ivan.anzel@um.si)

Tel.: +386 2 220 7861

Web: <https://www.fs.um.si/tehnologija-materialov-in-preoblikovanje/>

#### 3.1 LABORATORY FOR MATERIALS



Head of the Laboratory

**Prof. Franc Zupanič**

E-mail: [franc.zupanic@um.si](mailto:franc.zupanic@um.si)

Tel.: +386 2 220 7863

Web: <https://www.fs.um.si/laboratorij-za-materiale/>

The Laboratory for Materials focuses on research and technologies of metallic materials and their composites. Our work includes the synthesis of new alloys and the characterisation of materials at various levels, including macro-, micro- and nanoscales. The knowledge gained from basic research is used successfully in applied research and for the needs of the metallurgical and metal processing industry. We offer comprehensive materials research (metallographic, fractographic, mechanical properties and others) to companies in our region. In addition, we integrate theoretical and practical knowledge of materials into the pedagogical process, where we take care of the education of young professionals in the fields of mechanical engineering, mechatronics and economic engineering. The students gain an in-depth understanding of metallic, ceramic, polymer and composite materials, their manufacturing and processing technologies, and approaches to the microstructural and mechanical characterisation of materials. We follow the international development of materials and technologies, transferring new discoveries and knowledge into our research and educational work.



Melting in a vacuum  
induction furnace

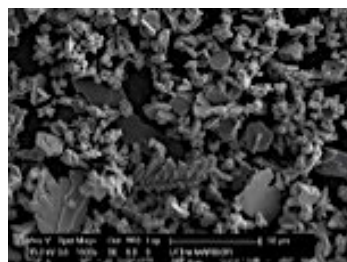

Extracted Al-alloy sample, prepared  
according to a patented process



Martensitic structure of steel,  
colour etching and light microscopy

#### MAJOR RESEARCH EQUIPMENT



**Furnaces for alloy smelting and heat treatment Bosio**

Maximum temperature 1100 °C.



### Metallographic Laboratory

Metallographic preparation of samples. Preparation of samples for light and scanning electron microscopy. Equipment for inserting samples into plastic, grinding, polishing and etching.



### Precision metallographic saw IsoMet 1000 Buehler

The IsoMet 1000 is a 7-inch [178 mm] gravity table saw designed to cut through a variety of materials with minimal material deformation. The saw is suitable for sensitive parts, as it uses only the force of gravity. It allows the use of a coolant and lubricating fluid and adjustable cutting speed (adjustable engine speed up to 1000 rpm).



### Metallographic saw Labotom-5 Struers

A manual metal cutting machine. Engine power 2.6 kW (3.5 hp). For 250 mm (10") cutting discs. With a cutting table with 10 mm T-slots. The recirculating cooling unit allows you to cool the workpiece.



### Vacuum induction melting furnace Leybold-Heraeus with a continuous casting machine Techica-Guss GmbH

The entire process, from the beginning of melting to complete cooling of the casting, takes place in a vacuum or protective atmosphere. Power: maximum 60 kW. Power regulation: Stepless, manual, frequency: 4 kHz (medium frequency induction melting furnace), vacuum  $10^{-2}$  mbar, crucible volume 3 l, minimum crucible filling about 1.5 l, maximum temperature 2000 °C.



### DURAVISION 20 Emco-Test Macro Hardness Meter

Brinell measurements according to EN ISO 6506, ASTM E10  
Rockwell measurements with EN ISO 6508, ASTM E18  
Vickers measurements in with EN ISO 6507, ASTM E384, ASTM E92  
Test load range 9.8–2450 N (1–250 kg), height adjustment with handwheel, measuring range  $\varnothing$  90 mm, max. workpiece weight 200 kg.



### Microhardness tester DURASCAN 50 Emco-Test

The automated microhardness tester enables individual measurements, measurements according to the Vickers mapping method (microhardness mapping) according to Vickers HV0.01, HV0.025, HV0.05, HV0.1, HV0.2, HV0.3, HV0.5, HV1, HV2, HV2.5, HV3, HV5, HV10, HV20, HV30, HV50. Automatic load adjustment (from 10 g to 62.5 kg).





**Micro- and Nanoindentation Nanotest Vantage Micro Materials**

Force range: from a tenth of an mN to 30 N  
 Macrohardness: from 2 N to 30 kN  
 Microhardness: less than 2 N, indentation depth more than 0.2  $\mu\text{m}$   
 Nanohardness: Indentation depth less than 0.2  $\mu\text{m}$   
 Temperature range: from room temperature to 400 °C  
 Determination of properties by micro- and nano-indentation: indentation hardness, Marten's hardness, indentation elastic modulus, response to cracking, topography and surface roughness, coefficient of friction, plastic and elastic work.



**Stereomicroscope Olympus SZ10 with EP50 camera Olympus**

Magnifications from 6.3x to 63x.

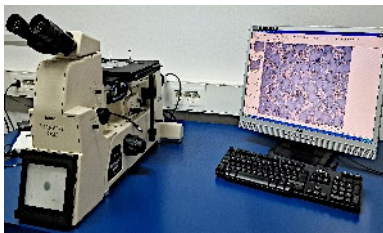

**Nikon Epiphot 300 Inverted Metallurgical Microscope Nikon**

equipped with the Soft Analysis image analysis program. A light microscope with a camera and with 5x, 10x, 20x, 20x, 50x and 100x lenses and 10x eyepieces, enables the analysis of flat metallographically prepared samples.

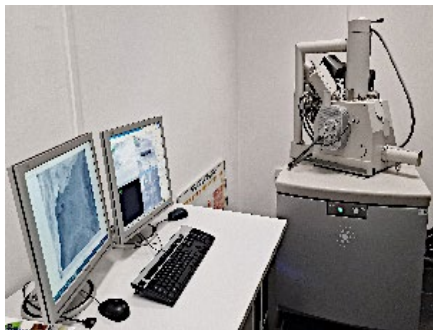

**QUANTA 200 3D Electron Ray Microscope with focused ion beam (SEM/FIB) FEI Company**

The Quanta 200 3D is an environmental line electron microscope with a system of double beams – electron and ion (dual beam). The microscope has the name "environmental" or the designation "ESEM" because it allows you to work at different pressures and at adjustable humidity. It allows the analysis of non-conductive samples without additional sample preparation. It is equipped with an ion column and a gas system for platinum deposition.



**HRSEM electron scanning microscope SIRION 400 FEI Company, equipped with an EDS analyser for microchemical analyses INCA 350 Oxford Instruments**

The SIRION FEG is a high-resolution field electron emission electron microscope. The Schottky origin of electrons allows for field emission and an electron beam with a small diameter and high density. Resolution: 1.0 nm at 15 kV or 2.0 nm at 1 kV.



**Jeol JFC 1100E Thin Metal Coating Sprayer Jeol**

Apparatus for the preparation of conductive samples for scanning electron microscopy.

## SERVICE OFFER AND SUPPORT TO THE ECONOMY

Metallographic and fractographic analysis:

- Metallographic preparation of samples, examination of surfaces, cracks and fractures.
- Light microscopy with image analysis.
- Scanning electron microscopy with microchemical EDS-analysis.
- Focused ion beam microscopy.
- Special metallographic techniques (colour etching of metals, deep etching and phase extraction).

Microscopy:

- Scanning electron microscopy of polymeric materials and other electrically and thermally non-conductive materials and fixed biological samples.
- Environmental scanning electron microscopy of composite materials.

Metallographic analysis of layers and coatings:

- Thickness measurements.
- Definition of the microstructure of coatings (light and electron microscopy and focused ion beam microscopy).
- Measurements of the microhardness of coatings.

Hardness and microhardness measurements:

- HV microhardness measurements.
- Hardness measurements HB, HV and HRC.

Micro- and nanoindentation:

- Determination of properties by micro- and nanoindentation: indentation hardness, Martens hardness, indentation elastic modulus, response to cracking, topography and surface roughness, coefficient of friction, plastic, elastic work.

Heat treatment of metals:

- Experimental heat treatment of metals in air.
- Analysis of heat treatment results (definition of hardness and microstructure and thickness of the treated surface).

Continuous casting:

- Production of alloys by vacuum induction melting and casting.
- Experimental continuous casting of special alloys.
- Determining the type of material for moulds and casting pots.
- Definition of the parameters for continuous casting of bars of small diameters.

## COOPERATION WITH RESEARCH AND OTHER INSTITUTIONS

- Jožef Stefan Institute, Ljubljana, Slovenia
- Faculty of Science, University of Ljubljana, Ljubljana, Slovenia
- Faculty of Mechanical Engineering, University of Ljubljana, Ljubljana, Slovenia
- Faculty of Chemistry and Chemical Technology, University of Ljubljana, Ljubljana, Slovenia
- IMT Ljubljana, Ljubljana, Slovenia
- KIT – Karlsruhe Institute of Technology, Karlsruhe, Germany
- CIC BiomaGUNE - Centre for Cooperative Research in Biomaterials, San Sebastian, Spain
- Ernst Ruska-Centre for Microscopy and Spectroscopy with Electrons (Forschungszentrum Jülich), Jülich, Germany
- HZDR-IBC, Dresden, Germany
- University of São Paulo, Department of Materials Engineering, Lorena School of Engineering, Brazil
- Elettra-Sincrotrone Trieste S.C.p.A. Trieste, Italy
- Institute of Crystallography - C.N.R. Sede Secondaria di Trieste, Trieste, Italy
- TU Graz, Austrian Centre for Electron Microscopy and Nanoanalysis, Graz, Austria
- University of Novi Sad, Faculty of Technical Sciences, Novi Sad, Serbia
- Ruđer Bošković Institute, Laboratory for Optics and Optical Thin Films, Zagreb, Croatia



### COOPERATION WITH COMPANIES

Impol, Omco Metals Slovenia, Cimos, Interkorn, Impol, Talum, Gselamn and Gselman, Premogovnik Velenje, Plana, Logicdata, Konus, Agis, Petrovič, d.o.o., ...

### MOST IMPORTANT RESEARCH ACHIEVEMENT

**Development of new high-strength aluminium alloys.** Cooperation in the development of new commercial aluminium alloys of the 6086 group. We have developed a new type of aluminium alloys that have three types of nanoparticles in their microstructure, which are well resistant to elevated temperatures, while, at the same time, providing high levels of strength at room temperature, for which we have obtained the European EPO patent. These types of nanoparticles are icosahedral quasicrystals, dodecahedral quasicrystals, and an ordered crystal phase, with the structure L1<sub>2</sub>. The main advantage of these alloys is that large cooling rates are not required to achieve the desired microstructure, and the appropriate size and arrangement of nanoparticles is achieved by stepwise heat treatment. Heat-resistant nanoparticles retain the strength properties of alloys up to at least 450 °C, while most aluminium alloys soften significantly after heating to 250°C.

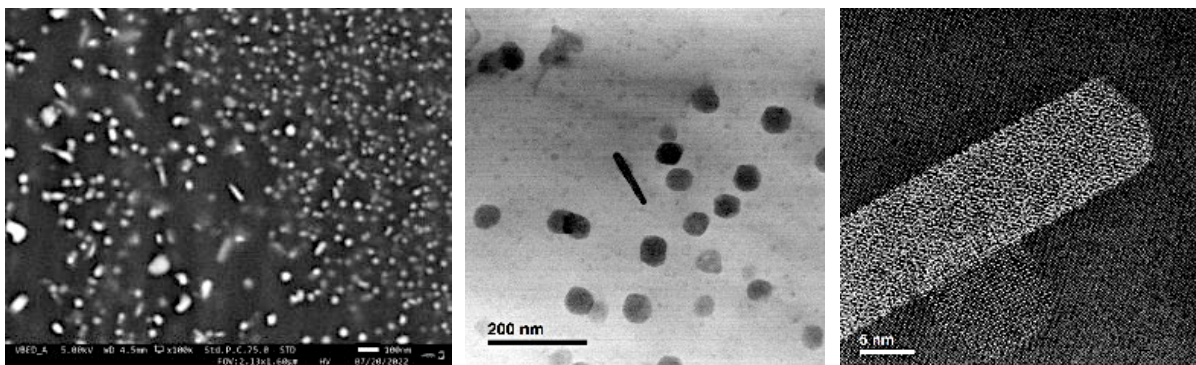

Scanning (SEM) and transmission (TEM) electron microscopy micrographs of quasicrystalline particles in aluminium alloys

**Development of a new 3D metallographic method of sample preparation by deep etching and extraction of particles from an aluminium or iron base.** The method enables the analysis of 3D morphology of crystalline and quasicrystalline phases, precise microchemical analysis (SEM) and transmission electron microscope (TEM), powder X-ray diffraction (XRD) and determination of the distribution of individual phases in a compact sample.

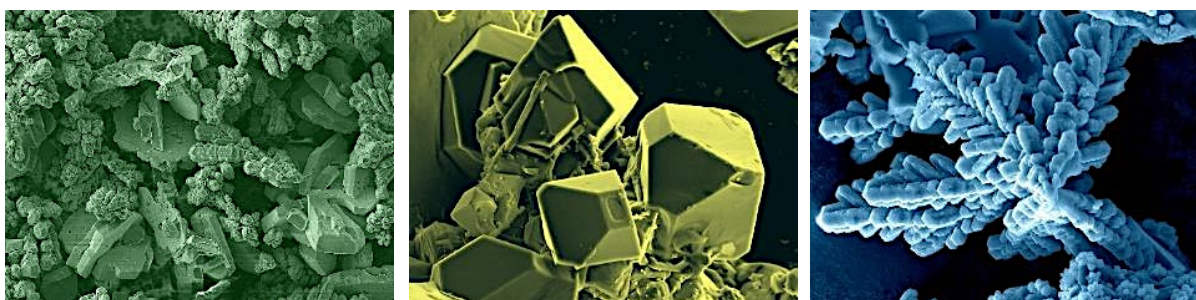

Scanning electron microscopy images of extracted phases from aluminium alloys

### PUBLICATIONS

1. ZUPANIČ, Franc, GSPAN, Christian, BURJA, Jaka, BONČINA, Tonica. Quasicrystalline and L1<sub>2</sub> precipitates in a microalloyed Al-Mn-Cu alloy. *Materials today communications*. Mar. 2020, vol. 22, str. 1–6, ilustr. ISSN 2352-4928. DOI: 10.1016/j.mtcomm.2019.100809
2. ZUPANIČ, Franc, ŽIST, Sandi, ALBA, Mihaela, LETOFSKY-PAPST, Ilse, BAUERN, Jaka, VONČINA, Maja, BONČINA, Tonica. Dispersoids in Al-Mg-Si alloy AA 6086 modified by Sc and Y. *Materials*. April 2023, vol. 16, iss. 8, [article no.] 2949, p. 24. ISSN 1996-1944. DOI: 10.3390/ma16082949.
3. MACERL, Matjaž, ZUPANIČ, Franc, HOČURŠČAK, Lara, KLOBČAR, Damjan, KOVÁCS, Andras, BONČINA, Tonica. Microstructure and properties after friction stir processing of twin-roll cast Al-Mn-Cu-Be alloy. *Crystals*. April 2022, vol. 12, iss. 5 (630), str. 18, ilustr. ISSN 2073-4352. DOI: 10.3390/cryst12050630.

4. BONČINA, Tonica, ALBU, Mihaela, ZUPANIČ, Franc. Ageing of Al-Mn-Cu-Be alloys for stimulating precipitation of icosahedral quasicrystals. *Metals*. July 2020, vol. 10, iss. 7 (937), str. 1–16.
5. ZUPANIČ, Franc, NUNES, Carlos A., COELHO, Gilberto Carvalho, CURY, Paula L., LOJEN, Gorazd, BONČINA, Tonica. Solidification of Be-free Ni-based dental alloy. *Transactions of Nonferrous Metals Society of China*. 2018, vol. 28, iss. 11, str. 2226-2235. ISSN 1003-6326. DOI: 10.1016/S1003-6326(18)64867-8.

#### PATENTS AND PATENT APPLICATIONS

- ZUPANIČ, Franc, BONČINA, Tonica. Manufacturing of high strength and heat-resistant aluminium alloys strengthened by dual precipitates = Herstellung von Hochfesten und wärmebeständigen durch dual-präzipitate verstärkten Aluminiumlegierungen = Fabrication d'alloyes d'aluminium à haute résistance mécanique et thermique plus plus des précipités doubles: European patent specification EP 3 456 853 B1, 2020-02-19. Munich: European Patent Office, 2020.
- ZUPANIČ, Franc, BONČINA, Tonica, LOJEN, Gorazd, NUNES, Carlos A., DOS SANTOS, Claudinei, COELHO, Gilberto Carvalho, ALKMIN, Luciano Braga, CORRÊA DE TOLEDO CURY, Paula Letícia. Excretion-hardened dental Ni-alloy with a high proportion of Nb produced by continuous casting process: patent No. SI 24599 A, date of publication 31.7.2015; Patent Application No. P-201400313, date of application 15.9.2014 Ljubljana: Intellectual Property Office of the Republic of Slovenia, 2015.
- BONČINA, Tonica, ZUPANIČ, Franc, MARKOLI, Boštjan. Procedure of dynamic deep etching and particle extraction from aluminium alloys: European patent EP2458033, granted 6.9.2013; published on 9.10.2013; application no. 11468004.4-2122, 4. October 2011. Munich: Europäisches Patentamt: = European Patent Office: = Office européen des brevets, 2013
- BONČINA, Tonica, ZUPANIČ, Franc. Process for the preparation of samples of polymer nanocomposite coatings for electron microscopy: Patent No. SI 23688 A, date of publication 28.9.2012; Patent Application No. P-201200144, date of filing of application 10.5.2012. Ljubljana: Intellectual Property Office of the Republic of Slovenia, 2012. BONČINA, Tonica, ZUPANIČ, Franc, MARKOLI, Boštjan. Dynamic deep etching and particle extraction process from aluminium alloys: SI 23106 A, 2011-01-31. Ljubljana: Intellectual Property Office of the Republic of Slovenia, 2011. 8 p. [COBISS. SI-ID 14779414]Patent Family: Patent Application No. P-201000313, 2010-10-11.
- MRVAR, Primož, MEDVED, Jože, ZUPANIČ, Franc, BONČINA, Tonica, STEINACHER, Matej. Process for the manufacture of magnesium alloy and ceramic foam composite panels and composite panels: patent: SI 23365 (A), 2011-11-30. Ljubljana: Intellectual Property Office of the Republic of Slovenia, 2011.

#### ARIS RESEARCH PROGRAMME

P2-0120 Technologies of Metastable Materials

I0-0029 Infrastructural Activity of the University of Maribor

#### NATIONAL AND INTERNATIONAL PROJECTS

- Nanostructured coatings of high-entropy alloys for use in toolmaking. An application project.
- The influence of temperature conditions on the microstructure and mechanical properties of additively manufactured materials. A fundamental project.
- Access to large infrastructure project ReMade@ARI (REcyclable MAterials DEvelopment at Analytical Research Infrastructures).
- Access to large infrastructures under the project NFFA.EU.

#### MEMBERSHIPS

- Slovenian Microscopy Society
- German Society for Materials Science e.V.
- European Microscopy Society

### 3.2 LABORATORY FOR MATERIALS FORMING



Head of the Laboratory

**Prof. Ivan Anžel**

E-mail: [ivan.anzel@um.si](mailto:ivan.anzel@um.si)

Tel.: +386 2 220 7861

Web: <https://www.fs.um.si/laboratorij-za-preoblikovanje-materialov/>

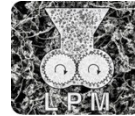

In the Laboratory for Materials Forming, laboratory exercises are carried out as part of the pedagogical process at undergraduate and postgraduate Study Programmes, and studies and analyses of processes and phenomena in transformation or design processes are carried out in the framework of research activities. These activities pursue the fundamental goal of achieving the desired, targeted microstructure and planned properties by optimising the parameters of the transformation or design of the products.

In all areas of human activity, new materials are being introduced constantly, and, as a result, alternative product design processes. In the Laboratory for Materials Forming, we follow these trends through research work on a new compounding system, studies of the production of modern polymer composite and hybrid materials using 3D printing, analyses of plastic flow mechanisms in modern engineering materials, and the development of special transformation processes (e.g., ECAP). Studies of material recycling processes and analyses of the impact of technological processes on the environment are also carried out, with the aim of following sustainable development in the field of Materials and Technology Development.

#### MAJOR RESEARCH EQUIPMENT



#### PROCESS 11 ThermoFisher Scientific

The experimental system for compounding nano- and microstructural polymer composites and metal glasses enables basic research in the field of the synthesis of polymer composites, metal glasses and metal and ceramic powder mixtures. The modular design of the system offers a study of the influence of process parameters on the microstructure and properties of composites, a study of the geometry of screws on the homogeneity of mixtures, the mechanism of mixing and kneading, the study and measurement of rheological properties of composite melts, the

study of the influence of additives (stabilisers, lubricants, antioxidants, UV stabilisers, pigments...) on the properties of melts, the influence of technological parameters on the homogeneity of melts and the influence of crystallisation on the structure and properties of metal glasses. The system also enables research into the recyclability of polymer composite mixtures – polymer alloys. This laboratory extruder is ideal for various types of compounding, such as: 3D filaments, a foil making system, a pellet making device.



**The device for monitoring processes in materials with the measurement of electrical resistance** is designed to monitor the processes of melt crystallisation, and enables continuous and non-destructive monitoring: directional solidification (the rate of solidification front, temperature gradient in liquid), equiaxed solidification (solidification interval, cooling velocity) and heat treatment (the kinetics and mechanisms of phase changes in the solid state in many heat treatments: recrystallisation, normalisation, soft annealing, tempering, cementing, nitriding, high temperature oxidation...).





#### HAAKE MiniJet Pro ThermoFisher Scientific

The device for injection moulding of polymer and composite materials is capable of injection moulding of various sample geometries and standard test testers with the help of a piston injection moulding system. The main characteristics: small sample volume from 2 to 12.5 ml of material, quick and easy to use, interchangeable moulds, test specimens can be made from powders, pellets or direct melt transfer, sample geometry from established standards to customised moulds.



#### HAAKE MARS ThermoFisher Scientific

The rheometer enables the determination of the rheological properties of composite melts, the mechanical properties of composite materials, and the analysis of the impact of manufacturing process parameters on the structure, properties and recyclability of the developed composites. The device can be used to measure viscosity, elasticity and temperature-related mechanical changes in samples. With this type of measurement, we can optimise product development, improve productivity and quality. It is designed to allow the use of all related assemblies, including the head and electronic measuring systems, which can be replaced at will. Features: controlled test chamber (from -150 °C to +600 °C), solid clamps for Dynamic Mechanical Thermal Analysis (DMTA), simple HAAKE RheoWin software.



#### RAISE 3D E2 3D Printer with Two Independent Nozzles

**Raise** The 3D printer has two independent nozzles (IDEX – Independent Dual Extruders), so it is possible to 3D print with two different colours or compatible materials at the same time. Since the nozzles are completely separated, multiple objects can be 3D printed with both at the same time, thus halving the time of 3D printing. Features: different nozzle tip diameters (0.2 / 0.4 / 0.6 / 0.8 / 1.0 mm), closed chamber for maintaining the ambient print temperature, the 3D printer can be controlled and monitored remotely via the built-in camera and Wi-Fi or Ethernet connection, large print area: 330 x 240 x 240 mm, wide range of materials up to 300 °C, flexible printing surface that allows the safe removal of models.

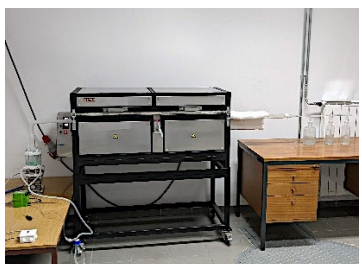

#### USP-device for ultrasonic dispersing pyrolysis of our in-house design and manufacture.

The basis of the device is an ultrasonic aerosol generator (UZ) with a frequency of 1.6 MHz, with a maximum capacity of 0.5 L/h. The aerosol is transported from the ultrasound generator with an inert gas (typically N<sub>2</sub>). The reactor consists of two heating zones and a reaction tube. The heating zones have lengths of 400 mm and a maximum temperature of 1000 °C, with the possibility of adding a third zone. The quartz glass reaction tube has a length of 1800 mm and a diameter of 35 mm, and at a length of 700 mm it has a side tube that allows the supply of a reducing gas, such as H<sub>2</sub>. The basic design of the catching system is wet capture of nanoparticles in liquids and enables catching in glass containers and Teflon containers.

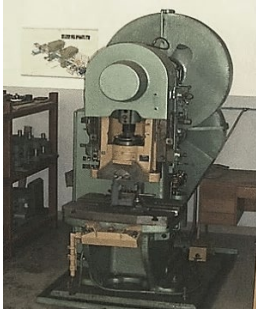

#### Eccentric press AUE 600 kN Hiltman Lorenz

Processing and transformation of material with less physical effort, processing in a shorter time. Cutting and punching of various products, including semi-finished products, which can be used further in other finishing processes (machining, heat treatment, etc.).



#### SMA Testing Stacy

A device for training one-way and two-way shape memory of shape memory alloys. The device is sensitive enough to measure the small loads required by small and thin strips. The device enables thermomechanical cycling up to 200 °C, as well as the unloading and testing of the effect of bidirectional design memory.



#### Hydraulic press WEB WEMA ZEULENRODA 250 MP

Metal processing in cold and hot states. Forming by bending, deep drawing, compression, material thinning, counter-extrusion and DC extrusion, process combinations, etc. For processes of transforming large areas of sheet metal, cutting off and bending pieces at the same time.



#### Universal Experimental Tool FS - ITM 6502 - 010

A free compression tool, bending, ring test, pressure test for determining plasticity curves.

### SERVICE OFFER AND SUPPORT TO THE ECONOMY

- The compounding system offers companies development support in the field of the Synthesis of new polymer and composite materials, and in the field of the development of new technological processes, and the production of polymer-based composite materials.
- The compounders offer flexible compounding configurations for small batches for either pilot production or low volume production and are well suited for R&D in the polymeric, pharmaceutical, biological and nanotechnology sectors.
- Study of the influence of manufacturing parameters on the structure and properties of composite and polymeric materials, using only a few grams of input raw materials.
- Simulation and optimisation of the compounding production process.
- Determination of rheological properties.
- Production of standard test testers from polymer and composite materials with the HAAKE MiniJet Pro injection system for testing the mechanical, optical or rheological properties of the sample.
- 3D printing for a wide range of materials up to 300 °C, print size 330 x 240 x 240 mm.
- Synthesis of nanoparticles.
- In situ measurements of electrical resistance in various heat treatments.
- Metal processing in cold and hot states.
- Forming using various tools (free compression, bending, ring test, cold extrusion, deep drawing, shear cutting tools)



### COOPERATION WITH RESEARCH AND OTHER INSTITUTIONS

- Institute of Metal Materials and Technologies Ljubljana, Ljubljana, Slovenia
- Institute of Chemistry Ljubljana, Ljubljana, Slovenia
- Faculty of Polymer Technology Slovenj Gradec, Slovenj Gradec, Slovenia
- Faculty of Natural Sciences and Engineering, University of Ljubljana: Synthesis and Characterisation of Materials, Ljubljana, Slovenia
- Jožef Stefan Institute Ljubljana, Ljubljana, Slovenia
- Faculty of Medicine in Ljubljana. Ljubljana, Slovenia
- National Institute of Biology, Ljubljana, Slovenia
- Biotechnical Faculty, Ljubljana, Slovenia
- Montanuniversität Leoben, Leoben, Austria
- NAME RWTH Aachen, Aachen, Germany
- Faculty of Metallurgy Sisak, Sisak, Croatia

### COOPERATION WITH COMPANIES

MLM, d. d., Farmtech, d. o. o., Paloma, d. d., Magneti, d. d., Impol, Weler Abrasive, Wire

### MOST IMPORTANT RESEARCH ACHIEVEMENT

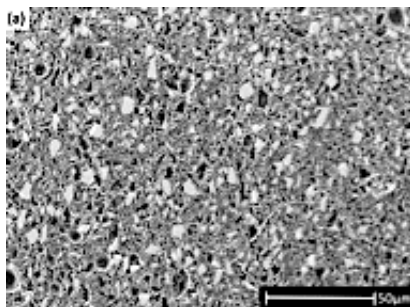

**Development of new types of filaments for 3D printing of plastomagnets and the development of new hybrid plastomagnets, in which the matrix is made of TPU and PA12, and the magnetic particles of NdFeB are a combination of particles made with "melt spin" technology and gas atomisation.**

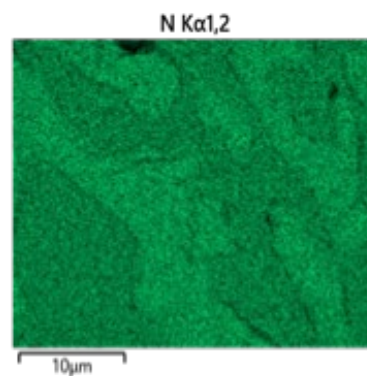
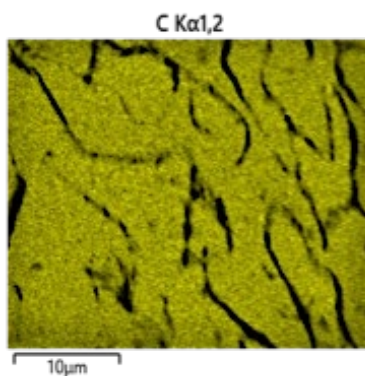
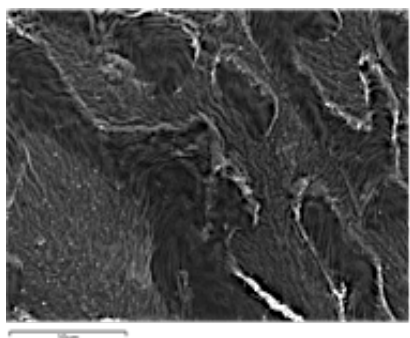

### PUBLICATIONS

1. BRUNČKO, Mihael, KIRBIŠ, Peter, ANŽEL, Ivan, GUSEL, Leo, FEIZPOUR, Darja, IRGOLIČ, Tomaž, VUHERER, Tomaž. Evaluation of the impact and fracture toughness of a nanostructured bainitic steel with low retained austenite content. *Materials*. Feb. 2023, vol. 16, iss. 5, [article no.] 2003, str. 12. ISSN 1996-1944. DOI:10.3390/ma16052003. [COBISS. SI-ID144522499], [JCR,SNIP,Wos,Scopus] Funded by: ARRS, Program, P2-0120, SI, Technologies of Metastable Materials.
2. ELEN, Žiga, KRAJEWSKI, Marcin, ZUPANIČ, Franc, MAJERIČ, Peter, ŠVARC, Tilen, ANŽEL, Ivan, EKAR, Jernej, LIOU, Sz-Chian, KUBACKI, Jerzy, TOKARCZYK, Mateusz, RUDOLF, Rebeka. Melting point of dried gold nanoparticles prepared with ultrasonic spray pyrolysis and lyophilisation. *Nanotechnology reviews: Elektronski vir*. [Online ed.]. July 2023, vol. 12, iss. 1, str. 12. ISSN 2191-9097. DOI:10.1515/ntrev-2022-0568. [COBISS. SI-ID158645507], [JCR,SNIP,Wos,Scopus]financer: This research was funded by the Slovenian Research Agency Training and funding of a Young Researcher, (Co) Financing Agreements nos. 1000- 19-0552, 1000-20-0552, and 1000-21-0552; ARRS, Programi, P2-0120, SI, Tehnologije metastabilnih materialov.

3. GÖKEN, J., SABA, N., ANŽEL, Ivan. Analysis of acoustic radiation of rectangular wooden panels made of spruce, maple and cherry wood. *Journal of alloys and compounds*. [Print ed.]. 25 October 2022, vol. 919 (165879), str. 10. ISSN 0925-8388. DOI:10.1016/j.jallcom.2022.165879. [COBISS. SI-ID112503299], [JCR,SNIP,Wos,Scopus].
4. FRAS ZIEMIČ, Lidija, KRAŠEVAC GLASER, Tjaša, PLOHL, Olivija, ANŽEL, Ivan, ŠIMAT, Vida, ČAGALI, Martina, MEŽNAR, Eva, MALIN, Valentina, STERNIŠA, Meta, SMOLE MOŽINA, Sonja. Biomass-derived plant extracts in macromolecular chitosan matrices as a green coating for PLA films. *Journal of functional biomaterials*. 2022, vol. 13, iss. 4 (228), p. 1-19, illus. ISSN 2079-4983. <https://www.mdpi.com/2079-4983/13/4/228> TWC:10.3390/jfb13040228. [COBISS. SI-ID128975619], [JCR,SNIP,Wosuntil 2023-10-07: Citations (TC): 2, Pure Citations (CI): 1, Pure Citations Per Author (CIAu): 0.10,Scopusuntil 2023-09-21: Citations (TC): 2, Clean Citations (CI): 1, Pure Citations Per Author (CIAu): 0.10].
5. KIRBIŠ, Peter, ANŽEL, Ivan, BRUNČKO, Mihael. Continuous casting of high carbon nanostructured bainitic steel = Continuous casting of high carbon nanostructured bainitic steel. *Livarski vestnik: newsletter of the Foundry Association of Slovenia*. 2022, year. 69, no. 1, p. 53-59, illus. ISSN 0024-5135. <http://www.dlib.si/details/URN:NBN:SI:doc-XGG17EBL>. [COBISS. SI-ID 104306179].

#### PATENTS AND PATENT APPLICATIONS

- Steels with fast kinetics of bainite formation and the method of production of said steel: Patent SI 25891 A, 2021-03-31. Kirbish, Peter; Brunčko, Mihael; Anžel, Ivan; Večko Pirtovšek, Tatjana. Type of work: 2.24 patent. Year: 2021. COBISS. SI-ID 83654659.
- Measuring probe for monitoring heat treatment of metallic materials: Decision on granting patent No. SI 22176 A, date of publication 30.06.2007; Application No. P-200500302, application date 07.11.2005. Brunčko, Mihael; Anžel, Ivan; Bosio, Hugo. Type of work: 2.24 patent. Year: 2007. COBISS. SI-ID 10489366
- Measuring cell for monitoring directional solidification: decision on granting a patent of the Intellectual Property Office of the Republic of Slovenia No. SI 21765 A, (application no. P-200400115, application date 14.4.2004, date of publication of the application 31.10.2005). Brunčko, Mihael; Anžel, Ivan; Križman, Alojz. Type of work: 2.24 patent Year: 2005. COBISS. SI-ID 9994006

#### ARIS RESEARCH PROGRAMME

P2-0120 Technologies of Metastable Materials

IO-0029 Infrastructural Activity of the University of Maribor

#### NATIONAL AND INTERNATIONAL PROJECTS

- A new generation of plasmomagnets. Ministry of Economy, Tourism and Sport, RDP No. 631-49/2020/1
- 3D-printed plasmomagnets. Ministry of Economic Development and Technology, No. 4300-2/2027/149

#### MEMBERSHIPS

- Slovenian Materials Society
- Slovenian Society for Electron Microscopy
- German Society for Materials Science e.V.
- Foundry Association of Slovenia

### 3.3 UNIVERSITY CENTRE FOR ELECTRON MICROSCOPY



Head of the Centre

**Prof. Ivan Anžel**

E-mail: [ivan.anzel@um.si](mailto:ivan.anzel@um.si)

Tel.: +386 2 220 7861

Web: <https://www.fs.um.si/univerzitetni-center-za-elektronsko-mikroskopijo/>



The University Centre for Electron Microscopy - UCEM, was established in 2005 as the first infrastructural research centre at the University of Maribor, with the aim of combining knowledge and experience in the field of electron microscopy, and as a research support in the analysis of all types of metallic, ceramic, polymer, composite and hybrid materials. UCEM's activities are aimed at connecting materials science with the

materialographic preparation of samples, and with the characterisation techniques that electron microscopy at UCEM enables (SEI, BEI, EDX analysis, EBSD analysis, SXES analysis, FIB, etc.), with the aim of identifying microstructural constituents and determining the properties of materials depending on the technological processes of production/treatments. It is also possible to observe in environmental mode, which is used successfully for research in the fields of biology, chemistry and medicine. Support is also provided for the analysis of specific samples that are poorly thermally and electrically conductive, soft (e.g., aerogels), volatile (e.g., vanillins), or liquid (e.g., oil droplets). The use of FIB/SEM ion microscopy also enables the physical processing of individual atomic layers of samples. With the help of knowledge and experience, UCEM offers reliable, high-quality and professionally competent support in the characterisation of materials. Research work in the field of Electron Microscopy is related to acquired research projects and programmes, within which new ways and methods of characterisation are also introduced. The contents of research programmes and projects include the identification and characterisation of microstructural elements, the analysis of the impact of manufacturing technologies on the development of microstructure, and studies of the interdependence between microstructure, properties and technology of material production.

### MAJOR RESEARCH EQUIPMENT



#### JSM-IT 800 SHL JEOL high-resolution scanning electron microscope FEG SEM with EDX, EBSD and SXES spectrometers JEOL

The high-resolution field electron microscope is designed for the observation of microstructural constituents using various detectors (SED-topography, BED-composition or Z-contrast, UHD high-resolution topography, UED-high-resolution composition) in different observation modes (STD, BD, LDF). With the STEM detector, it is possible to analyse transmitted electrons in samples of thickness up to 50 nm. With integrated EDX, EBSD and SXES spectrometers, the system enables qualitative and quantitative microchemical analysis, crystallographic phase analysis, determination of crystal grain orientation, detection of light trace elements, and spectroscopy of the chemical state of

atoms in microstructural phases. The system enables accurate microchemical analysis in a very short time at high resolution. The SXES spectrometer, which enables the determination of the energy states of binding electrons or the density of the states of valence electrons, is distinguished by its superior energy resolution (1.2 eV). The microscope is distinguished by high resolution (0.5 nm) at an acceleration voltage of 15 kV, and excellent resolution (0.9 nm) at a very low acceleration voltage of 0.5 kV. It also enables observation at extremely low accelerating voltages – 0.01 kV, which is favourable for observing non-conductive samples (polymeric materials, ceramics, biological preparations).



**The SIRION 400 NC FEI high-resolution field-emission-electron microscope FEI**, equipped with an **EDX-analyser** is a high-resolution field-emission electron microscope that enables extremely high magnifications and high resolution (1 nm). It is equipped with an EDX spectrometer for qualitative and semi-quantitative microchemical analysis and enables qualitative and semi-quantitative microchemical spot and area analysis, qualitative line analysis and surface distribution of elements (mapping). Elements ranging from beryllium to uranium can be analysed. Its good resolution at low accelerating voltage also allows the observation of non-conductive samples and materials containing components with a low atomic number.

Samples can be observed in a high or low vacuum (up to 130

Pa). The microscope is equipped with an SED (topographic contrast) and BED (topographic and Z-contrast) detector. In addition, it is possible to analyse transmitted electrons in samples of thickness up to 50 nm with a STEM detector.



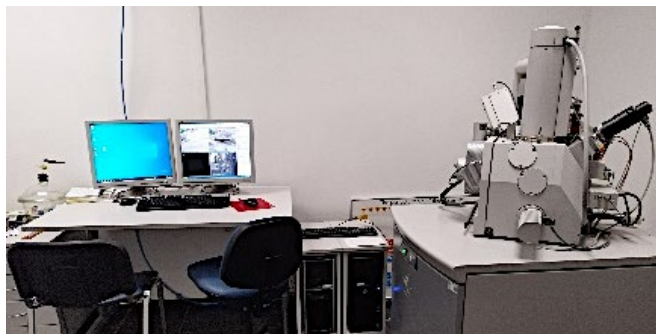

**The QUANTA 200 FEI 3D Environmental Line Electron Microscope with an Ion Gun and Platinum Deposition System** is an environmental electron microscope with thermal emission of electrons. The microscope allows you to work at different pressures and at 100% humidity. The environmental mode of operation – ESEM, is suitable for the analysis and characterisation of non-conductive samples (polymeric materials, ceramics, non-conductive surface layers, biological and medical preparations, etc.), and is

especially important for the observation of moist, oily and dirty samples, and for the observation of in-situ processes (hydration, dissolution, etc.). In addition to the electron source (electron gun), the microscope is also equipped with an ion source (ion gun), which, in addition to observing the surface, also allows surface treatment and analysis of the microstructure below the surface. Non-standard equipment on the microscope is a platinum deposition system that protects the surface from damage that would occur during ion cutting.



**COOLING CROSS SECTION POLISHER IB-19520CCP JEOL**

The CCP device is designed for superior cross-sectional preparation of a sample for observation with a scanning electron microscope. The device is equipped with a TVBA holder, that allows the prepared sample to be transferred in a vacuum to the chamber of the JSM-IT 800 SHL electron microscope in such a way that the sample does not meet the atmosphere after cross-sectional preparation. The CCP also includes a CCA adapter for carbon spraying. Compared with conventional mechanical polishing, CCP creates a very uniform cross-section without milling defects. The device is also useful for the preparation of cross-

sections of heat-sensitive materials. With the option of the intermittent milling of samples (On-OFF-ON mode) cooled with liquid nitrogen (down to -120 °C), the concentration is reduced of defects on the surface of polished samples that may arise due to the influence of heat.



**CRYO ION SLICER ONE-09090CIS JEOL**

An apparatus for the automatic preparation of thin wafers for observation by means of a transmission electron microscope (TEM). A beam of Ar ions is used for the preparation of wafers, with the possibility of cooling the sample carrier down to - 120 °C.



**Ion Spatter JFC-1100A Geol**

An apparatus for spattering a thin layer of gold onto the surfaces of poorly conductive or electrically non-conductive samples for the observation and examination of these surfaces by line electron microscopes.



**DIAMOND WIRE SAW MODEL 4500 WELL**

A diamond saw on a thin wire with diamonds for precise cutting of thin slices up to a thickness of 100 µm, for the preparation of TEM samples.



#### **Buehler Materialographic Sample Preparation Devices**

Devices for materialographic preparation of samples are intended for the preparation of surfaces of various materials for the needs of microstructural characterisation and analysis with an optical and electron microscope. Materialographic preparation of samples includes cutting samples on a precision or high-speed saw; mounting the samples (cold or hot mounting); grinding and polishing of samples on an automatic grinding and polishing device; and chemical or electrolytic etching.



#### **NIKON Epiphot 300 s kamero OLYMPUS DP12 Olympus**

An inverted metallurgical optical microscope for microstructural characterisation of polished and etched surfaces of materials, with the possibility of magnification from 50x to 1000x. Quantitative stereological evaluation of the microstructure is also enabled with the connected computer program AnalysSIS.



#### **OLYMPUS SZX10 s Camera EP50 Olympus**

A flexible stereomicroscope for routine examinations. The microscope has a magnification range of 10:1 with a magnification range of 0.63x–6.3x magnification. The microscope is equipped with a stand that allows tilting. Microscopic samples can be imaged with the EP50 camera.

### **SERVICE OFFER AND SUPPORT TO THE ECONOMY**

- Preparation of samples for optical and electron microscopy.
- Microstructural characterisation and analysis of materials by optical and electron microscopy.
- Development of special methods for the characterisation of nanoparticles, nanostructured materials and other advanced materials.
- Analyses and control inspections of precious metal alloys for jewellery and dental prosthetics.
- Implementation of infrastructural support to users, undergraduate and postgraduate students, researchers at UM, UL and other research organisations and companies in research in the fields of Engineering Materials and biological and medical samples.
- Analysis of samples of ceramic, composite and polymer materials.
- Preparation of soft, wet and volatile biological and medical samples to preserve the original shape and structure.
- Determining the properties of materials and advising on further processing of materials to achieve the desired properties or solving technological problems in the processing of materials.
- Quality control of highly demanding industrial products and development of new materials and technologies in companies.
- Microscopy at different pressures in the EM chamber, which allows the analysis of thermally and electrically non-conductive samples, as well as the monitoring of in-situ processes in the chamber.
- Microscopy with ion-beam (SEM/FIB).

### **COOPERATION WITH RESEARCH AND OTHER INSTITUTIONS**

- Institute of Metal Materials and Technologies Ljubljana, Ljubljana, Slovenia
- Institute of Chemistry Ljubljana, Ljubljana, Slovenia
- Faculty of Polymer Technology Slovenj Gradec, Slovenj Gradec, Slovenia
- Faculty of Natural Sciences, University of Ljubljana, Ljubljana, Slovenia
- Jožef Stefan Institute Ljubljana, Ljubljana, Slovenia
- Faculty of Medicine in Ljubljana, Ljubljana, Slovenia



- National Institute of Biology, Ljubljana, Slovenia
- Biotechnical Faculty, Ljubljana, Slovenia
- Montanuniversität Leoben, Leoben, Austria
- NAME RWTH Aachen, Aachen, Germany
- Faculty of Metallurgy Sisak, Sisak, Croatia

#### COOPERATION WITH COMPANIES

Talum, Paloma, d.d., TÜV SÜD Sava, Magneti, d.d., Štore Steel, Unior Zreče, Impol, Zlatarna Celje, d.d., Weiler Abrasive, Wire, Magna Steyr, Slovenska industrija jekla, Acroni Jesenice, Metal Ravne, Cimos.

#### MOST IMPORTANT RESEARCH ACHIEVEMENT

**Development of techniques for microstructural and microchemical characterisation of nanoparticles of various metal, ceramic and polymeric nanostructured materials.**

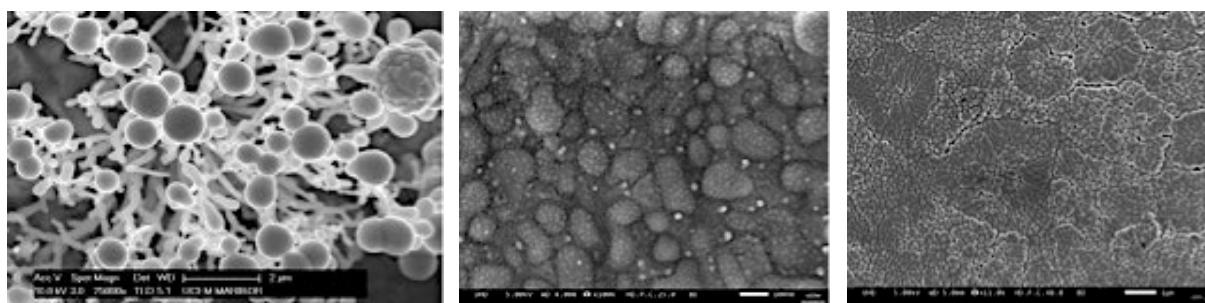

The images show nanoparticles and the microstructure of a high-entropy alloy from the Ag-Pt-Pd-Cu-Ni system after rapid solidification.

#### PUBLICATIONS

1. GÖKEN, J., SABA, N., ANŽEL, Ivan. Analysis of acoustic radiation of rectangular wooden panels made of spruce, maple and cherry wood. *Journal of alloys and compounds*. [Print ed.]. 25 October 2022, vol. 919 (165879), str. 10. ISSN 0925-8388. DOI:10.1016/j.jallcom.2022.165879. [COBISS. SI-ID112503299], [JCR,SNIP,Wos,Scopus]
2. JUG, Andraž, BRUNČKO, Mihael, RUDOLF, Rebeka, ANŽEL, Ivan. Oxidation behaviour of microstructurally highly metastable Ag-La alloy. *Materials*. Mar. 2022, vol. 15, iss. 6 (2295), str. 18. ISSN 1996-1944. DOI:10.3390/ma15062295. [COBISS. SI-ID101707267], [JCR,SNIP,Wosuntil 2023-09-14: Citations (TC): 2, Clean Citations (CI): 2, Pure Citations Per Author (CIAu): 0.50,Scopusuntil 2023-09-11: Citations (TC): 2, Clean Citations (CI): 2, Pure Citations Per Author (CIAu): 0.50]
3. SIMIČ, Lidija, RUDOLF, Rebeka, MAJERIČ, Peter, ANŽEL, Ivan. Cast microstructure of a complex concentrated noble alloy Ag<sub>20</sub>Pd<sub>20</sub>Pt<sub>20</sub>Cu<sub>20</sub>Ni<sub>20</sub>. *Materials*. July 2022, vol. 15, iss. 14 (4788), str. 14, ISSN 1996-1944 [COBISS. SI-ID114803715], [JCR,SNIP,Wosuntil 12/12/2022: Citations (TC): 1, Clean Citations (CI): 0, Clean Citations Per Author (CIAu): 0.00,Scopusuntil 2023-02-20: citations (TC): 1, pure citations per author (CIAu): 0.00]
4. SIMIČ, Lidija, STOPIČ, Srečko, FRIEDRICH, Bernd, ZADRAVEC, Matej, JELEN, Žiga, BOBOVNIK, Rajko, ANŽEL, Ivan, RUDOLF, Rebeka. Synthesis of complex concentrated nanoparticles by Ultrasonic Spray Pyrolysis and lyophilisation. *Metals*. Oct. 2022, vol. 12, iss. 11 (1802), str. 1–16, ilustr. ISSN 2075-4701. DOI:10.3390/met12111802. [COBISS. SI-ID127093763], [JCR,SNIP,Wosuntil 2023-05-12: Citations (TC): 1, Pure Citations (CI): 1, Pure Citations Per Author (CIAu): 0.13,Scopusuntil 2023-04-26: Citations (TC): 1, Clean Citations (CI): 1, Pure Citations Per Author (CIAu): 0.13]
5. TIYYAGURA, Hanuma Reddy, MAJERIČ, Peter, BRAČIČ, Matej, ANŽEL, Ivan, RUDOLF, Rebeka. Gold inks for inkjet printing on photo paper: complementary characterisation. *Nanomaterials*. [Online ed.]. Feb. 2021, vol. 11, iss. 3 (599), str. 1–13, ilustr. ISSN 2079-4991. DOI:10.3390/nano11030599. [COBISS. SI-ID53366019], [JCR,SNIP,Wosuntil 2023-04-17: Citations (TC): 7, Clean Citations (CI): 4, Clean Citations Per Author (CIAu): 0.80,Scopusuntil 2023-04-29: Citations (TC): 8, Pure Citations (CI): 5, Pure Citations Per Author (CIAu): 1.00]

#### PATENTS AND PATENT APPLICATIONS

- Steels with fast kinetics of bainite formation and the method of production of the said steel: Patent SI 25891 A, 2021-03-31. Kirbish, Peter; Brunčko, Mihael; Anžel, Ivan; Večko Pirtovšek, Tatjana. Type of work: 2.24 patent. Year: 2021. COBISS. SI-ID 83654659.

- Measuring probe for monitoring heat treatment of metallic materials: Decision on the grant of Patent No. SI 22176 A, date of publication 30.6.2007; Application No. P-200500302, application date 7.11.2005 Brunčko, Mihael; Anžel, Ivan; Bosio, Hugo. Type of work: 2.24 patent. Year: 2007. COBISS. SI-ID 10489366.
- Measuring cell for monitoring directed solidification: decision on granting a patent of the Intellectual Property Office of the Republic of Slovenia No. SI 21765 A, (application No. P-200400115, application date 14.4.2004, date of publication of the application 31.10.2005). Brunčko, Mihael; Anžel, Ivan; Križman, Alojz. Type of work: 2.24 patent Year: 2005. COBISS. SI-ID 9994006.

#### ARIS RESEARCH PROGRAMME

P2-0120 Technologies of Metastable Materials

I0-0029 Infrastructural Activity of the University of Maribor

#### NATIONAL AND INTERNATIONAL PROJECTS

- Dostop do velikih infrastruktur v okviru projekta ReMade@ARI / REcyclable MAterials DEvelopment at Analytical Research Infrastructures
- Access to large infrastructures under the project NFFA.EU

#### MEMBERSHIPS

- Slovenian Materials Society
- Slovenian Society for Electron Microscopy
- German Society for Materials Science e.V.
- Foundry Association of Slovenia

## 4. MECHANICS

In the field of Mechanics, there is one laboratory:

LABORATORY:	HEAD:
4.1 Laboratory for Applied Mechanics	Boštjan Harl



Head of the Chair of Mechanics  
**Prof. Nenad Gubelj**  
 E-mail: [nenad.gubelj@um.si](mailto:nenad.gubelj@um.si)  
 Tel.: +386 2 220 7661  
 Web: <https://www.fs.um.si/mehanika/>

### 4.1 LABORATORY FOR APPLIED MECHANICS



Head of the Laboratory  
**Assis. Prof. Boštjan Harl**  
 E-mail: [bostjan.harl@um.si](mailto:bostjan.harl@um.si)  
 Tel.: +386 2 220 7809  
 Web: <https://www.fs.um.si/mehanika/>

Work in the laboratory is divided into three key sets of activities. The first set focuses on the development of methodologies and with them associated algorithms for optimising the topology of load-carrying structural elements. This approach makes it possible to improve the efficiency and strength of structures by minimising the material. The second set covers the development of algorithms and numerical procedures to investigate crack growth in different materials and under different loading conditions. This segment provides a better understanding of the mechanisms of crack growth, as well as predicting the behaviour of materials under real conditions. The third set includes the development of advanced numerical algorithms and related software within the framework of numerical mechanics. This includes the development and implementation of numerical optimisation methods to improve the accuracy and efficiency of simulations and optimise the design of structures. The development of methodologies for the optimisation of structural parts, as well as algorithms for crack growth analysis and advanced numerical algorithms in the laboratory, is crucial to produce solid, safe and economical structures in various industries.

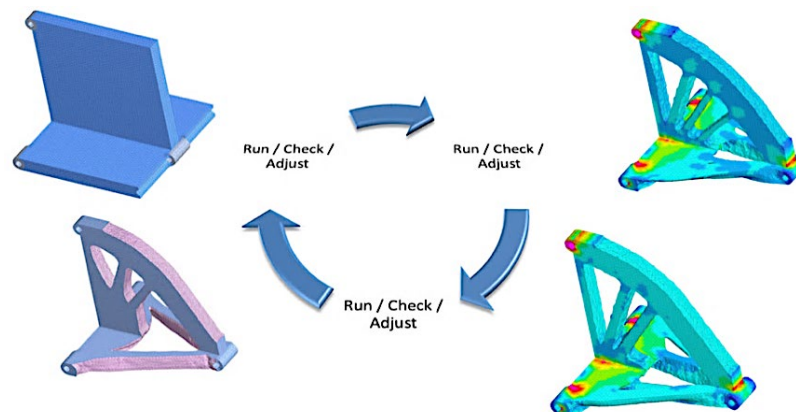

Topological optimisation cycle

### RESEARCH EQUIPMENT



Microsoft software for developing and writing code  
 CAESS topological optimisation software  
 PTC modelling and numerical simulation software

### SERVICE OFFER AND SUPPORT TO THE ECONOMY

- Preparation of numerical models, planning and implementation of the optimisation of the topology of load-carrying structural parts.
- Consulting in planning and implementation of optimisation projects for various mechanical systems.
- Development of dedicated algorithms and related software in the field of Numerical Mechanics and Optimisation Methods.

### COOPERATION WITH RESEARCH AND OTHER INSTITUTIONS

- Erich Schmid Institute of Materials Science, Leoben, Austria
- Materials Center Leoben, Leoben, Austria
- Vienna University of Technology, Vienna, Austria
- Department of Mechanical and Mining Engineering, University of Jaen, Jaen, Spain
- Faculty of Electrical Engineering, Mechanical Engineering and Naval Architecture, University of Split, Split, Croatia
- Faculty of Mechanical Engineering and Naval Architecture, University of Zagreb, Zagreb, Croatia
- Faculty of Civil Engineering and Geodesy, University of Ljubljana, Ljubljana, Slovenia
- Faculty of Mechanical Engineering, University of Ljubljana, Ljubljana, Slovenia
- Faculty of Chemistry and Chemical Technology, University of Maribor, Maribor, Slovenia

### COOPERATION WITH COMPANIES

Elan, d.o.o., Begunje, Slovenia

### MOST IMPORTANT RESEARCH ACHIEVEMENT

Development of a **procedure for the fine-tuning of cellular structures of load-bearing structural parts**, to achieve certain mechanical properties of the load-carrying part. Developed process allows for the fine-tuning of various cellular structures that can be used as carrier assemblies or fillers. The procedure is based on the application of topology optimisation on an appropriately topologically processed domain. The topological processing of the domain is performed with the help of a special numerical tool called a configurator.

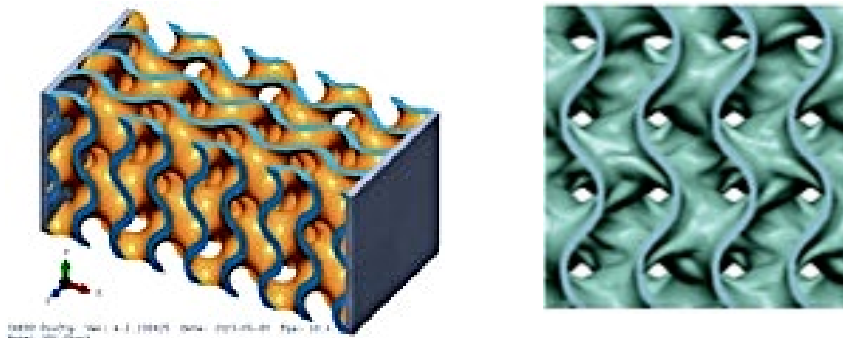

Results show that this process can improve cell structures by adjusting, for example, the stiffness of the structural part, or the ability to dissipate energy through plasticisation of the material.

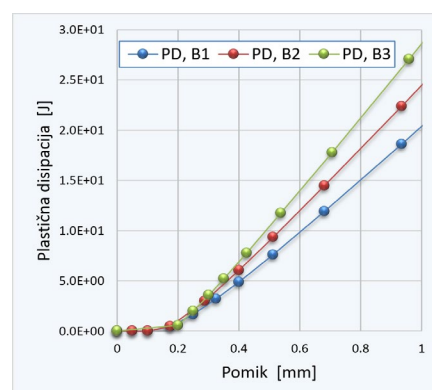
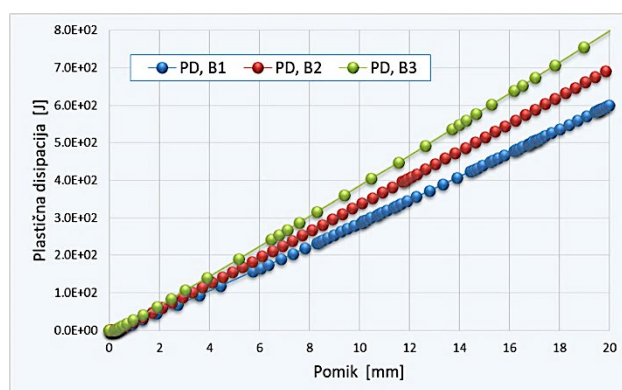

## PUBLICATIONS

1. KOLEDNIK, Otmar, ABHISHEK, Tiwari, POSCH, C., KEGL, Marko. *Configurational force-based analysis of creep crack growth. International journal of fracture, ISSN 0376-9429, July 2022, vol. 236, iss. 2, str. 175–199, doi: 10.1007/s10704-022-00645-z. [COBISS. SI-ID 119909379]*
2. BRESCAKOVIC, Drazen, KEGL, Marko, KOLEDNIK, Otmar. *Interaction of crack and hole: effects on crack trajectory, crack driving force and fracture toughness. International journal of fracture, ISSN 0376-9429, July 2022, vol. 236, iss. 1, str. 33–57, doi: 10.1007/s10704-021-00611-1. [COBISS. SI-ID 118609923]*
3. RAMADANI, Riad, PAL, Snehashis, KEGL, Marko, PREDAN, Jožef, DRSTVENŠEK, Igor, PEHAN, Stanislav, BELŠAK, Aleš. *Topology optimization and additive manufacturing in producing lightweight and low vibration gear body. International journal of advanced manufacturing technology, ISSN 0268-3768, Published: 03 March 2021, str. [1–13], doi: 10.1007/s00170-021-06841-w. [COBISS. SI-ID 54234371]*
4. PREDAN, Jožef, KEGL, Marko, ABART, R., FISCHER, Franz Dieter, RAMMERSTORFER, Franz G. *On an alternative approach for simulating chemically induced crack pattern evolutions in a single crystal. International journal of solids and structures, ISSN 0020-7683. [Print ed.], Oct. 2020, vol. 202, str. 575–586, doi: 10.1016/j.ijsolstr.2020.06.006. [COBISS. SI-ID 26865923]*
5. TORRES JIMÉNEZ, Eloisa, DORADO VICENTE, Ruben, KEGL, Breda, KEGL, Marko. *One-dimensional modeling and simulation of injection processes of bioethanol-biodiesel and bioethanol-diesel fuel blends. Fuel, ISSN 0016-2361. [Print ed.], Sep. 2018, vol. 227, str. 334–344. <https://www.sciencedirect.com/science/article/pii/S0016236118307609>, doi: 10.1016/j.fuel.2018.04.118. [COBISS. SI-ID 21388566]*

ARIS RESEARCH PROGRAMME P2-0137 Numerical and Experimental Analysis of Nonlinear Mechanical Systems

## MEMBERSHIPS

- Slovenian Society of Mechanics



## 5. PRODUCTION ENGINEERING

There are 10 laboratories in the field of Production Engineering:

LABORATORY:	HEAD:
5.1. Laboratory for Additive Manufacturing	Igor Drstvenšek
5.2 Laboratory for Intelligent Manufacturing Systems	Mirko Ficko
5.3 Laboratory for Mechatronics	Uroš Župerl
5.4 Laboratory for Production and Operation Management	Borut Buchmeister
5.5 Laboratory for Machining Processes	Simon Klančnik
5.6. Laboratory for Oil Hydraulics	Darko Lovrec
5.7 Laboratory for Flexible Manufacturing Systems	Mirko Ficko
5.8 Laboratory for Robotisation	Timi Karner
5.9. Laboratory for Discrete Systems Simulation	Borut Buchmeister
5.10 Laboratory for Production Measurement	Bojan Ačko



Head of the Chair of Production Engineering

**Prof. Bojan Ačko**

E-mail: [bojan.acko@um.si](mailto:bojan.acko@um.si)

Tel: +386 2 220 7581

Web: <https://www.fs.um.si/proizvodno-strojinstvo/>

### 5.1 LABORATORY FOR ADDITIVE MANUFACTURING



Head of the Laboratory

**Prof. Igor Drstvenšek**

E-mail: [igor.drstvensek@um.si](mailto:igor.drstvensek@um.si)

Tel: +386 2 220 7593

Web: <https://www.fs.um.si/laboratorij-za-dodajalno-izdelavo/>

The laboratory is involved in development and research in the field of 3D printing, as additive technologies are commonly known. We deal with the analysis of the processes that take place in the materials during the additive manufacturing processes and with the structural manipulation of the materials to improve their machinability and process productivity. In the area of application, we deal with the use of additive manufacturing in medicine, particularly in the fields of neurosurgery, orthopaedics, traumatology and facial surgery, where we collaborate with both clinical centres in the production of medical devices tailored to individual patients or users. Since 2004, we have collaborated with various neurosurgery departments on more than 50 cranioplasties.

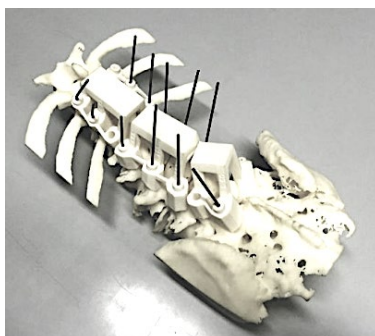

Layout guides  
Pedicle screws

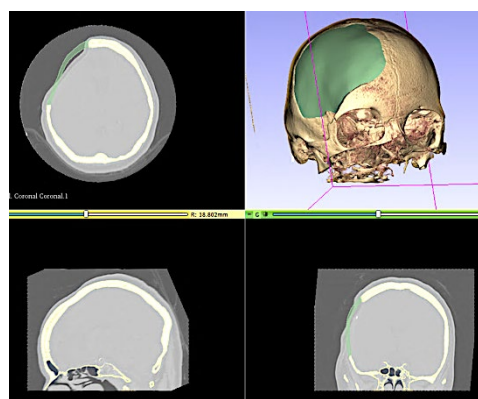

Modelling of a cranial implant

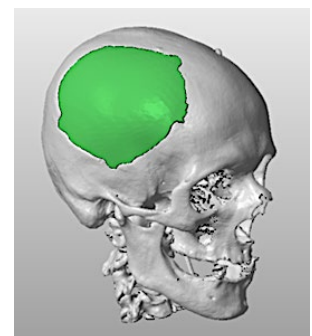

In the medical field, in addition to the development of medical products, we are researching the possibilities of producing new biocompatible materials, in particular metal alloys, which mimic the mechanical properties of bone and enable suitable osseointegration. In the industrial sector, we work with numerous industrial partners, both in determining the processing parameters for various polymer and metal materials and in developing new additive manufacturing devices or auxiliary processes for additive manufacturing.

## MAJOR RESEARCH EQUIPMENT



### Freemelt ONE Freeman AB

FreemeltONE is a device for the additive manufacturing (3D printing) of metal products using electron beam melting technology. It is equipped with a 6-kW electron gun and a working chamber with a diameter of 100 mm and a height of 100 mm. The device operates in a vacuum with metal powders with a grain size of 0.07 to 0.15 mm. The vacuum that allows the electron gun to operate is between  $10^{-6}$  hPa in the electron gun tube and  $10^{-7}$  hPa in the working chamber. Melting under these conditions enables metallographic and mechanical properties that cannot be achieved under normal operating conditions. The device is fully configurable, which opens unlimited possibilities in the field of materials research and the production of new alloys and materials with functionally graded microstructures.



### LMP 200 Dentas

A device for the additive manufacturing (3D printing) of metal products using laser melting technology. It is equipped with a 200 W Yb: glass laser and a working area of 125 x 125 x 200 mm<sup>3</sup>. The layer thickness is adjustable from 0.015 to 0.1 mm. The device works with metal powders with a grain size of 0.03 to 0.06 mm and takes place in a protective atmosphere that allows the use of reactive materials. It contains an integrated material handling system that prevents contamination of the material. The software allows the optional modification of process parameters, which enables various experiments and the development of new materials for additive manufacturing.



### Formiga P110 Velocis EOS

The device for laser sintering of polymer materials enables the rapid production of relatively large parts from PA12 and other materials. It is equipped with a 30 W CO<sub>2</sub> laser and a working area of 240 x 190 x 300 mm<sup>3</sup>. The layer thickness is adjustable from 0.06 to 0.1 mm. The device works with polymer powders and takes place in a protective atmosphere that prevents oxidation and ensures the production of fully functional products.



### ATO Lab + 3D Lab

An ultrasonic atomiser is a device that is suitable for operation under laboratory conditions. The core of the device consists of a plasma arc that forms between the tungsten electrode and the electrode attached to the sonotrode, which oscillates at a frequency of 35 kHz. The device enables the production of powders from various metal preforms (round rods or wire). The powders have a spherical shape, which is required for selective laser melting.



#### Lisa PRO Sinterit

Lisa pro is a laser sintering device which, due to its design, enables experiments with various polymer materials as well as the production of small plastic prototypes from materials such as PA6, PA11, TPE and the like.



#### Asiga Pro 4K Asiga

A stereolithography device that uses a DLP projector instead of a laser to photoactivate polymer resins. The device enables the rapid production of prototype models and the development of new photopolymer materials.



#### Heat treatment furnace Dentas

The furnace enables the thermal treatment of metal products, which can be carried out both in a vacuum and with the support of various protective gases.

### SERVICE OFFER AND SUPPORT TO THE ECONOMY

- 3D printing of small batches of finished products and prototypes.
- Reverse engineering.
- Introducing additive technologies into medicine.
- Courses for the operator of laser sintering and melting machines.
- Modelling courses in the SolidWorks software environment.
- Development and production of medical devices and models, and assistance in the 3D-digital planning of surgical procedures.

### COOPERATION WITH RESEARCH AND OTHER INSTITUTIONS

- Department of Civil Engineering, Ljubljana, Slovenia
- University Medical Center Ljubljana, Ljubljana, Slovenia
- Olympic Games Ljubljana, Ljubljana, Slovenia
- UKC Maribor, Maribor, Slovenia
- SB Celje, Celje, Slovenia
- SB Murska Sobota, Murska Sobota, Slovenia
- SB Ptuj, Ptuj, Slovenija
- Faculty of Polymer Technology, Slovenj Gradec, Slovenia
- Management Center Innsbruck, Innsbruck, Austria
- Montanuniversität Leoben, Leoben, Austria
- Alto University, Helsinki, Finland
- University of Twente, Enschede, Netherlands

- Loughborough University, Loughborough, United Kingdom
- SINTEF, Trondheim, Norway
- Queen Mary Hospital, Hong Kong, China
- Hong Kong University, Hong Kong, China
- Technical University of Cluj-Napoca, Cluj-Napoca, Romania
- Technical University of Košice, Košice, Slovakia
- University of Novi Sad, Novi Sad, Serbia
- University of Zagreb, Zagreb, Croatia

#### COOPERATION WITH COMPANIES

Talum, d.d., Kidričveo, Impol, d.d., Slovenska Bistrica, Cinkarna Celje, d.o.o., Celje, Dentas, d.o.o., Maribor, Seltron, d.o.o., Maribor, KOLN 3D, Ltd., Geneva, Switzerland

#### MOST IMPORTANT RESEARCH ACHIEVEMENT

The use of computer-aided design, specialised surgical skills and additive manufacturing technologies provides patients with individualised, better planned, more predictable and more reliable treatment than traditional surgery. Precise surgical planning is common in all medical fields when it comes to invasive procedures on the human body, regardless of medical specialisation. Surgical planning is always based on diagnostic data which must be collected, visualised and evaluated in a way that corresponds to the final goal. To understand the general needs of surgical planning, the Additive Manufacturing Laboratory has studied and analysed several surgical cases over the last 10 years. In all cases, **the diagnostic data was converted into three-dimensional models** which were later used for planning and, after confirming the planned therapeutic parameters, transformed into a tangible surgical device using additive manufacturing. The three-dimensional planning process has many advantages but requires some skills that are not common among physicians. The results of our research summarise the specifics of three-dimensional planning and provide guidelines for the wider use of patient-friendly medical devices made with additive manufacturing technologies.

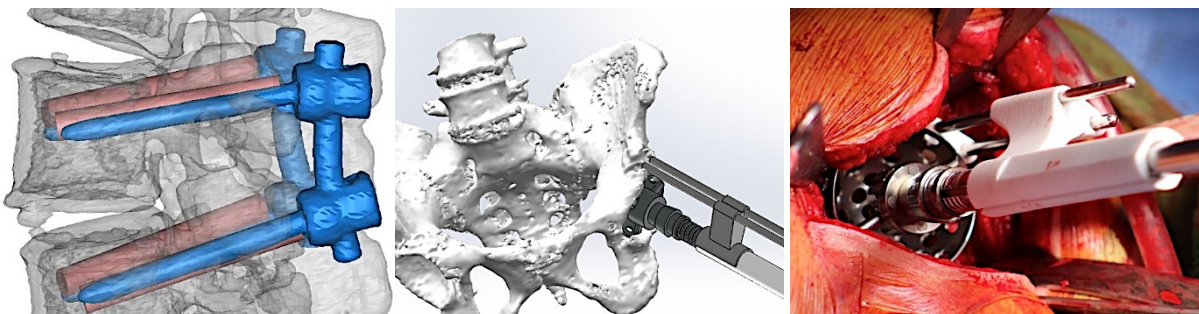

#### PUBLICATIONS

1. PAL, Snehashis, LOJEN, Gorazd, HUDAK, Radovan, RAJTUKOVA, Viktoria, BRAJLIH, Tomaž, KOKOL, Vanja, DRSTVENŠEK, Igor. As-fabricated surface morphologies of Ti-6Al-4V samples fabricated by different laser processing parameters in selective laser melting. *Additive manufacturing*. [Print ed.]. May 2020, vol. 33 (101147), str. 1–14, ilustr. ISSN 2214-8604. DOI: 10.1016/j.addma.2020.101147.
2. BRAJLIH, Tomaž, VALENTAN, Bogdan, BALIČ, Jože, DRSTVENŠEK, Igor. Speed and accuracy evaluation of additive manufacturing machines. *Rapid prototyping journal*. 2010, vol. 17, iss. 1, str. 64–75. ISSN 1355-2546. DOI: 10.1108/13552541111098644.
3. DRSTVENŠEK, Igor, ZUPANIČ, Franc, BONČINA, Tonica, BRAJLIH, Tomaž, PAL, Snehashis. Influence of local heat flow variations on geometrical deflections, microstructure, and tensile properties of Ti-6Al-4V products in powder bed fusion systems. *Journal of manufacturing processes*. [Print ed.]. May 2021, vol. 65, str. 382–396. ISSN 1526-6125. DOI: 10.1016/j.jmapro.2021.03.054.
4. PAL, Snehashis, GUBELJAK, Nenad, HUDAK, Radovan, LOJEN, Gorazd, RAJTUKOVA, Viktoria, BRAJLIH, Tomaž, DRSTVENŠEK, Igor. Evolution of the metallurgical properties of Ti-6Al-4V, produced with different laser processing parameters, at constant energy density in selective laser melting. *Results in physics*. 2020, vol. 17 (103186), str. 1–9, ilustr. ISSN 2211-3797. DOI: 10.1016/j.rinp.2020.103186.



5. VAJDA, Jernej, BANOVIĆ, Luka, MIŠKO, Mihael, DRSTVENŠEK, Igor, MILOJEVIĆ, Marko, MAVER, Uroš, VIHAR, Boštjan. *Algorithmic linearization improves Syringe-based extrusion in elastic systems using Hydrogel-based materials. Materials & design. May 2023, vol. 229, [article no.] 111884, str. 13. ISSN 0264-1275. <https://dk.um.si/lzpisGradiva.php?id=84161>, <https://dk.um.si/lzpisGradiva.php?id=84161>, DOI: 10.1016/j.matdes.2023.111884.*

#### ARIS RESEARCH PROGRAMME P2-0137 Technological Systems for Smart Manufacturing

##### NATIONAL AND INTERNATIONAL PROJECTS

- Development of safe multi-purpose catheter surfaces to prevent biofilm formation - DemoCat. L2-3163, 2024.
- Biofunctionalization of 3D-printed metal alloys as an emerging strategy to reduce the side effects of orthopaedic implants. J1-2470, 2012 - 2023.
- Advanced processing technologies for individualised 3D printed implants to prevent bacterial infections. J3-9262, 2012 - 2021.

##### MEMBERSHIPS

- Slovenian Institute for Standardization, Technical Committee SIST/TC VAR Welding
- European Technology Platform in Additive Manufacturing

## 5.2 LABORATORY FOR INTELLIGENT MANUFACTURING SYSTEMS



*Head of the Laboratory*

**Assoc. Prof. Mirko Ficko**

E-mail: [mirko.ficko@um.si](mailto:mirko.ficko@um.si)

Tel.: +386 2 220 7595

Web: <https://www.fs.um.si/laboratorij-za-inteligentne-obdelovalne-sisteme/>

The Laboratory for Intelligent Manufacturing Systems has more than 30 years of experience in the development and application of intelligent machining systems. For the analysis and optimisation of systems and influential process variables, it designs and conducts experiments and computer engineering simulations and develops predictive models. Machine learning, evolutionary algorithms, swarm intelligence, or artificial neural networks are often transferred to other areas by lab collaborators. The laboratory follows the evolution of artificial intelligence, from deep learning to the use of large-scale language models. It is also involved in the development of machine vision solutions for machine tools and systems. The laboratory is engaged in improving the capabilities of machining and production technologies.

##### MAJOR RESEARCH EQUIPMENT



##### **Five-axis CNC milling machine CV5-500 Mazak**

The five-axis CNC milling machine enables five-axis simultaneous milling of workpieces, whereby workpieces can be processed up to a diameter of 500 mm and a height of 320 mm.





**CNC sheet metal bending machine TruBend 3066 Trumpf**

The CNC machine has a working length of sheet metal bending of 2040 mm and allows a thrust force of 660 kN. It is equipped with a modern controller that allows you to simulate sheet metal bending using a digital twin. An ACB laser is used for automatic angle measurement and real-time compensation of elastic alignment, and the precise achievement of the position of the sheet before bending is enabled by a 4-axis rear support system, which also allows the connection of an industrial robot.



**CNC laser sheet metal cutting machine Bodor i7 Bodor**

The CNC laser sheet metal cutting machine is designed for laser cutting of sheet metal, and we can cut a wide range of steels (including stainless steel) and other materials (such as aluminium and brass). It is equipped with an ytterbium fibre laser beam source with a power of 3 kW and a working space of 3048 x 1524 mm<sup>2</sup>. The thickness of the sheet metal cutting depends on the type of material and the cutting gas used, and nitrogen and oxygen can be used for the cutting gas.

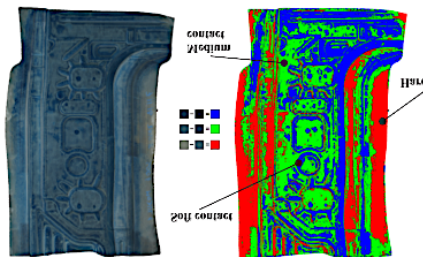

**Workstation for performing complex computer simulations CAM and developing algorithms using Artificial Intelligence**

The workstation consists of a high-performance processor, low-latency, high-capacity memory, and a Graphics Processing Unit with 10,496 CUDA cores and a 384-bit memory interface bandwidth. High-performance components enable the development and testing of optimisation algorithms, the design and training of Artificial Intelligence models, and the implementation of complex numerical simulations for computer-aided manufacturing.



**Tracker Vantage E6 Max Faro**

The FARO Tracker Vantage E6 Max is a high-precision laser measuring instrument that allows you to determine the position and movement of the measured object in a three-dimensional space. The equipment includes a portable laser tracking device with a battery for independent operation, spherical retroreflectors with a set of grips and backrests, a wireless sensor for measuring hidden places, with a set of connectors with different stem lengths and diameters of the tactile ball, and a CAM2 software license.

**SERVICE OFFER AND SUPPORT TO THE ECONOMY**

- Performing sheet metal forming simulations
- Performing simulations of slicing processing
- Implementation of single- and multi-criteria optimisations of production processes and systems
- Designing and learning AI models
- Development of methodology and implementation of technological measurements of large devices in demanding environments

**COOPERATION WITH RESEARCH AND OTHER INSTITUTIONS**

- Graz University of Technology, Graz, Austria
- University of Novi Sad, Faculty of Technical Sciences, Novi Sad, Serbia
- University of Sarajevo, Faculty of Mechanical Engineering, Sarajevo, Bosnia and Herzegovina
- Campus 02, Graz University of Applied Sciences, Graz, Austria

## COOPERATION WITH COMPANIES

Marovt, d.o.o., Inkolteh, d.o.o., SMM, d.o.o.

## MOST IMPORTANT RESEARCH ACHIEVEMENT

**Analysis of spotting images of forming tools.** The spotting of the forming tools and the analysis of the spotting image are an integral part of the toolmaking process that serve to determine the fit of the tool and the sheet metal part. The laboratory has unique experience in the field of digitisation of the spotting process. The digitised spotting process is patented and ready for industrial applications.



A system for the analysis of the spotting image consists of 3D-digitally optical capture of colour and geometric information of the spotted parts, the pre-processing of the captured data is made by decimation, segmentation according to the k-leader method, determination of the brightness level, meshing (2D and 3D) and display of areas with information about the quality of the deposition on the CAD model. In addition, the integration of spotting image analysis is also presented, with the results of a formation simulation for estimating of tool quality. Indicators have been developed to show the degree of coverage of point clouds, the degree of homogeneity and the luminosity properties of individual classes.

## PUBLICATIONS

1. GOTLIH, Janez, BREZOČNIK, Miran, PAL, Snehashis, DRSTVENŠEK, Igor, KARNER, Timi, BRAJLIH, Tomaž. A holistic approach to cooling system selection and injection molding process optimization based on non-dominated sorting. *Polymers*. Nov. 2022, vol. 14, iss. 22 (4842), str. 1–23, ilustr. ISSN 2073-4360. DOI: 10.3390/polym14224842. [COBISS. SI-ID 132370691]
2. GOTLIH, Janez, BREZOČNIK, Miran, KARNER, Timi. Stiffness-based cell setup optimization for robotic deburring with a rotary table. *Applied sciences*. Sep. 2021, vol. 11, iss. 17 (8213), str. 1–17, ilustr. ISSN 2076-3417. <https://www.mdpi.com/2076-3417/11/17/8213>, DOI: 10.3390/app11178213. [COBISS. SI-ID 75283459]
3. BERUS, Lucijano, KLANČNIK, Simon, BREZOČNIK, Miran, FICKO, Mirko. Classifying Parkinson's disease based on acoustic measures using artificial neural networks. *Sensors*, ISSN 1424-8220, 2019, vol. 19, no. 1, str. 1–15, ilustr. <https://dk.um.si/Dokument.php?id=132026>, doi: 10.3390/s19010016. [COBISS. SI-ID 21997846]
4. BRILI, Nika, FICKO, Mirko, KLANČNIK, Simon. Tool condition monitoring of the cutting capability of a turning tool based on thermography. *Sensors*, ISSN 1424-8220, Oct. 2021, vol. 21, iss. 19, str. 13, doi: 10.3390/s21196687. [COBISS. SI-ID 80136195]
5. FICKO, Mirko, BEGIĆ-HAJDAREVIĆ, Đerzija, HADZIABDIC, V., KLANČNIK, Simon. Multi-response optimisation of turning process parameters with GRA and TOPSIS methods. *International Journal of Simulation Modelling*, ISSN 1726-4529, 2020, vol. 19, iss. 4, str. 547–558, doi: 10.2507/IJSIMM19-4-524. [COBISS. SI-ID 41317123]

## PATENTS AND PATENT APPLICATIONS

- BERUS, Lucijano, FICKO, Mirko. System and method for assessing sheet metal forming tool snag: P-202200075, 3/13/2023. Ljubljana: Intellectual Property Office of the Republic of Slovenia, Ministry of Economy, Tourism and Sport, 2023. p. [15]. [COBISS. SI-ID 160682243]

ARIS RESEARCH PROGRAMME P2-0157 Technological Systems for Smart Manufacturing

## NATIONAL AND INTERNATIONAL PROJECTS

- Cognitive geometric control of mechanically processed forgings based on mass data from the machining process. 1.10.2021 - 30.09.2024.

### 5.3 LABORATORY FOR MECHATRONICS



*Head of the Laboratory*  
**Assoc. Prof. Uroš Župerl**  
 E-mail: [uros.zuperl@um.si](mailto:uros.zuperl@um.si)  
 Tel: +386 2 220 7621  
 Web: <https://www.fs.um.si/laboratorij-za-mehatroniko/>

The Laboratory for Mechatronics provides services in the field of analysis and synthesis of complex mechatronic systems. It deals with the design of control of technical systems, and the implementation of dynamic analyses of the behaviour of control components of various technical implementations. The laboratory optimises control systems using computer simulation models and analyses and synthesises computer control systems for remote control and control of technical systems. In addition, it is engaged in the design and maintenance of electrical, electronic, pneumatic, hydraulic and hybrid automatic control systems in the fields of production engineering, energy, process engineering and agricultural machinery. The laboratory is developing innovative solutions to improve the efficiency and reliability of mechatronic systems constantly and contributes to the progress of the industry by conducting advanced research and practical applications.

#### MAJOR RESEARCH EQUIPMENT



##### Fully automated Robotikbar FS, LAMEH

The application of three industrial robots and an intelligent logistics transport system for beverage delivery in the realisation of a fully automated bar. Using handheld terminals and a visual system the customer interacts with the robots and selects/orders a drink. The system incorporates Montrac's smart, innovative conveyor system, which ensures that the right drink is served to the right customer, even without supervision, thanks to the new Chaos technology. The bar, which was used by visitors at the Automatica fair in Germany, is a demonstration of how efficient and safe industrial robot and transport applications can be without a centralised control system.



##### Hydraulic servo system FS, LAMEH

Hydraulic mechatronic servo-axis, hydraulic cylinders with a connection plate, a Moog servo-valve, a Bosch proportional valve, a Hammer hydraulic power unit, microfilter, electronics, machine guides, and sleds with weights. The hydraulic servo system is used for the development and testing of complex control algorithms for electrohydraulic linear and rotary servo drives.



##### ROEMHELD D8.0115 Roemheld Group

A dedicated hydraulic power unit with appropriate control for hydraulic clamping systems and systems with zero positioning. The unit, with a working pressure of 300 bar, is an excellent choice for use in clamping systems.





**Industrial controllers Siemens, Bechhoff, Phoenix contact, ProConOS** Industrial controllers for the implementation of control procedures for the control of technical systems.

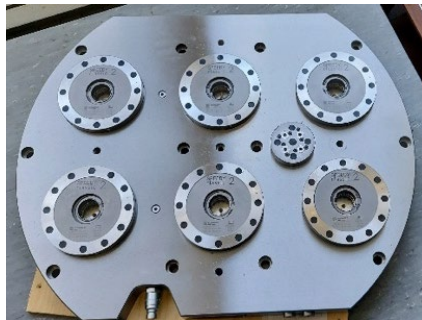

**Quick-clamping hydraulic module with integrated clamping system (NP module) Roemheld Group** For compatibility and interchangeability between industrial modules in the smart tool shop, a quick-clamping hydraulic module with an integrated clamping system (NP module) ensures fast clamping with repeatable positioning of machining pallets, clamps, clamping jigs and workpieces. The quick-release hydraulic module consists of a 6-pin quick-release pallet (attached to the machine table) and a quick-release pallet with integrated hydraulic clamps.

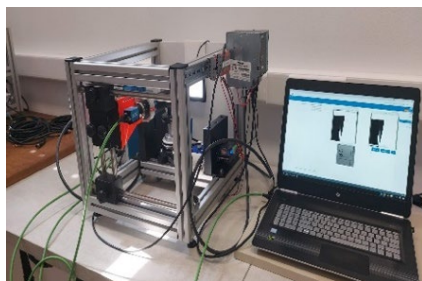

**Machine vision system SICK 2D vision sensor FS, LAMEH**

The system contains visual system elements for measuring tool wear and detecting damage to the cutting edge, along with hardware to connect the sensors to IoT applications on the sensor cloud. An essential element is an open-source sensor integration device for the development of high-performance, innovative and user-friendly solutions for sensor cloud applications for process control.



**Laser measuring cell SICK FS, LAMEH**

For high-precision measurements of cutting-edge wear and workpiece geometry, two high-performance laser distance sensors with high measuring accuracy and a frequency of 80 kHz, easy configuration with web-based interfaces, surface-independent measuring algorithms and interfaces for easy integration into multi-sensor measuring systems, are an excellent choice for high-precision measurements with high-performance measuring accuracy and an 80 kHz frequency.

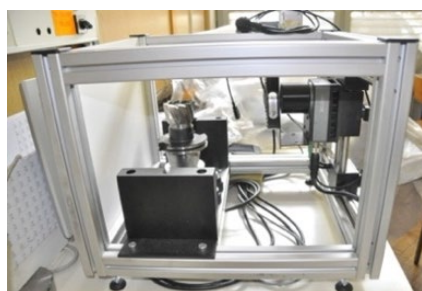

**Optical measuring system NI1772 C FS, LAMEH**

A visual system for monitoring the condition of the tool. It is used for dimensional control of cutting tools and measurement of tool wear.



**3D machine vision sensor SICK Ranger3 FS, LAMEH**

For surface quality inspection, for tool insert inspection and for quick measurements of the shape and colour of the cutting chips, a small, high-precision 3D camera with appropriate 1" optics and high measurement speeds, a CMOS sensor for high 3D performance, with the possibility of integration into multi-camera systems and with the appropriate configuration software (visualisation tools) in English is an excellent choice.



#### Halder Halder

A modular T-slot universal clamping module (set) and sensor-control system for identifying the position of the workpiece in the clamping fixture.



#### Halder Halder

Special clamping and positioning elements for the construction of clamping systems.

### SERVICE OFFER AND SUPPORT TO THE ECONOMY

- Analysis and synthesis of the most demanding mechatronic systems.
- Planning of control procedures for the technical systems.
- Conducting dynamic analyses of the behaviour of control and control components of various technical designs.
- Optimisation of control systems using computer simulation models.
- Analysis and synthesis of computer control systems for remote control and control of technical systems.
- Design of electrical, electronic, pneumatic, hydraulic and hybrid automatic control systems in the fields of production engineering, energy, process engineering, logistics and agricultural machinery.
- Functional education in the field of Mechatronics and control technology.
- Introduction of sensor technology into machining processes.
- Design of modern monitoring systems for milling processes.
- Computer modelling, simulation and optimisation of cutting and clamping processes.
- Design, production and testing of modular clamping jigs for cutting processes.
- Development of experimental methods for testing cutting tools and testing of modern cutting materials.

### COOPERATION WITH RESEARCH AND OTHER INSTITUTIONS

- Faculty of Mechanical Engineering, Ljubljana, Slovenia
- Technische Universität Wien, Vienna, Austria
- University of Applied Sciences, Fachhochschule Technikum Wien, Vienna, Austria
- Czech Technical University in Prague, Prague, Czech Republic
- Kielce University of Technology, Kielce, Poland
- University of Novi Sad, Novi Sad, Serbia
- Ss. Cyril and Methodius University in Skopje, Skopje, North Macedonia

### COOPERATION WITH COMPANIES

Štore steel, d.o.o., Halder, d.o.o., Erwin Halder KG, Emo orodjarna, d.o.o., SICK, d.o.o., Trilobit, d.o.o., N&N, d.o.o., Beckhoff Avtomatizacija, d.o.o., Siemens Trgovsko a servisno podjetje, d.o.o., ANSI Poslovni usluge Andrej Slekec, s.p., PPS Štefan Časar, s.p.

### MOST IMPORTANT RESEARCH ACHIEVEMENT

The **development of two-level cyber-physical machining systems** for monitoring the condition of the cutting tool, the quality of the treated surface, energy consumption and clamping stability. A cloud-based system structure is created for real-time monitoring of the tool's condition, by detecting the size of cutting chips in face milling. The system is designed to connect an IoT (Internet of Things) platform for monitoring the condition of tools in a private cloud with a machine tool and an optical system in the tool shop. The optical system takes care of capturing and transmitting the cutting chip size signals to the IoT application, where they are used as an indicator to determine the condition of the tool and the quality of the surface. The IoT cloud platform uses real-time Internet analytics services to monitor the surface quality and process correction in material processing,



where sudden wear and frequent tool damage occur. Analytical services in the form of Internet applications can be shared with other geographically distributed production systems in the machining shop. Artificial Intelligence, integrated into the platform with sample recognition capability, monitors the surface quality status by identifying the current trend of the calculated cutting force, and protects the tool from excessive loads by correcting the process parameters.

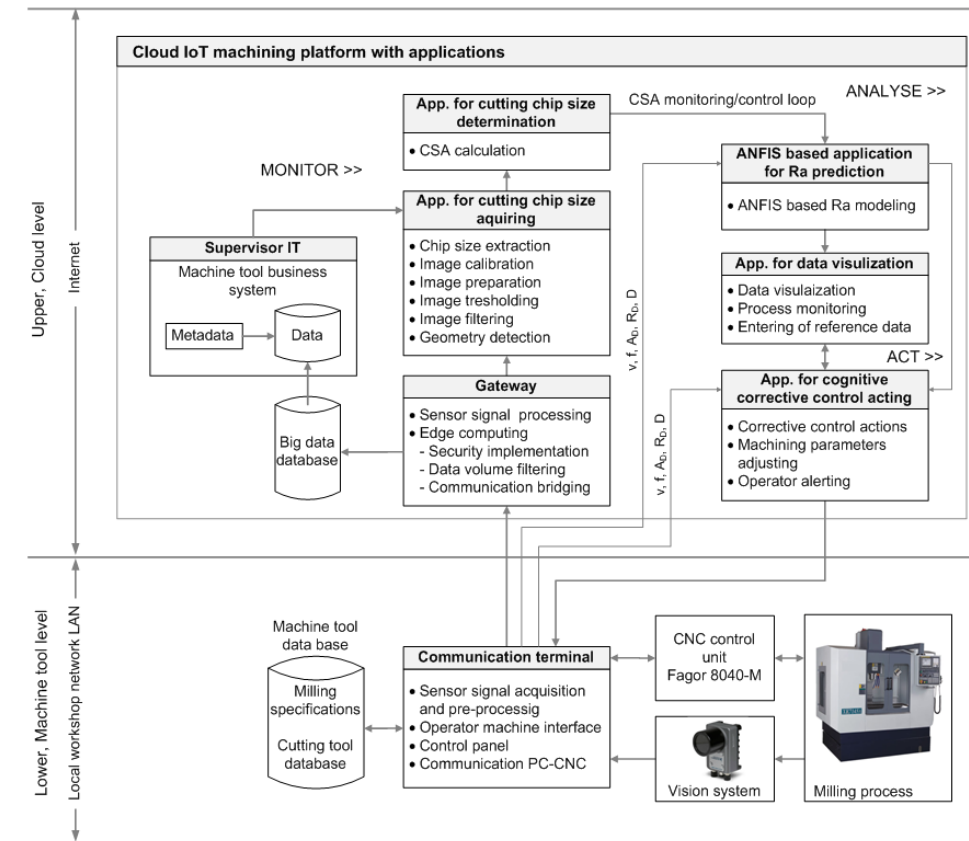

## PUBLICATIONS

1. KOVAČIČ, Miha, ŽUPERL, Uroš. Continuous caster final electromagnetic stirrers position optimization using genetic programming. *Materials and manufacturing processes*. 31 May 2023, vol. 38, iss. [12], str. 9, ilustr. ISSN 1042-6914. DOI: 0.1080/10426914.2023.2219317.
2. KOVAČIČ, Miha, ŽUPERL, Uroš, BREZOČNIK, Miran. Optimization of the rhomboidity of continuously cast billets using linear regression and genetic programming: A real industrial study. *Advances in production engineering & management*. Dec. 2022, vol. 17, no. 4, str. 469–478. ISSN 1854-6250. URN:NBN:SI:doc-QOYH8ZGS, DOI: 10.14743/apem2022.4.449.
3. ŚWIDERSKI, Jacek, WŁODZIMIERZ, Makiela, DOBROWOLSKI, Tomasz, STĘPIEŃ, Krzysztof, ŽUPERL, Uroš. The study of the roundness and cylindricity deviations of parts produced with the use of the additive manufacturing. *International journal of advanced manufacturing technology*. Aug. 2022, vol. 121, iss. 11/12, str. 7427–7437. ISSN 0268-3768. DOI: 10.1007/s00170-022-09838-1.
4. ŽUPERL, Uroš, KOVAČIČ, Miha, BREZOČNIK, Miran. An anfis-mechanistic simulator of tool loads in ball-end milling of layered metal materials. *International Journal of Simulation Modelling*. Dec. 2022, vol. 21, no. 4, str. 639–650. ISSN 1726-4529. DOI: 10.2507/IJSIMM21-4-624.
5. KOVAČIČ, Miha, ŽUPERL, Uroš. Modeling of tensile test results for low alloy steels by linear regression and genetic programming taking into account the non-metallic inclusions. *Metals*. Aug. 2022, vol. 12, iss. 8 (1343), str. 1–17, ilustr. ISSN 2075-4701. DOI: 10.3390/met12081343.

ARIS RESEARCH PROGRAMME P2-0157 Technological Systems for Smart Manufacturing

## NATIONAL AND INTERNATIONAL PROJECTS

- Metronet – a network for novel measuring and manufacturing technologies. PL-0007-18-2223

## MEMBERSHIPS

- DAAAM – Danube Adria Association for Automation & Manufacturing

#### 5.4 LABORATORY FOR PRODUCTION AND OPERATION MANAGEMENT



Head of the Laboratory

**Prof. Borut Buchmeister**

E-mail: [borut.buchmeister@um.si](mailto:borut.buchmeister@um.si)

Tel.: +386 2 220 7631

Web: <http://lanps.fs.um.si/>

The Laboratory for Production and Operations Management combines pedagogical work at all levels of study, and theoretical and user-oriented research work for institutions and industry. The basic area of activity of the laboratory is production management, which includes product development, work study, ergonomics, introduction of collaborative workplaces (cobots), capacity planning, layout planning, application of virtual reality, inventory management, quality and supply chain management, project management, maintenance, lean manufacturing and costs. We pay special attention to setting of time standards, ergonomic workplace design, collaborative workplace planning, process design and production planning and control. We also deal with project management, production process reliability planning, knowledge and innovation management and service management. With its extensive knowledge and analytical tools, our team develops effective and innovative solutions that help to improve production processes, make an effective green transition and increase competitiveness in the industry.

#### MAJOR RESEARCH EQUIPMENT



Collaborative robot **Universal Robots UR3e Universal Robots Denmark** and gripper **Robotiq 2F-85 Robotiq France**. The collaborative robot is changing the traditional form of work by freeing workers from the high-intensity and monotony of operations. It shares a common space with humans, and they perform a wide range of tasks together. The collaborative robot is equipped with a series of sensors and safety features, that allow it to detect and react to the presence of people in its workspace. Programming is not complicated, so it is suitable even for smaller series of products.

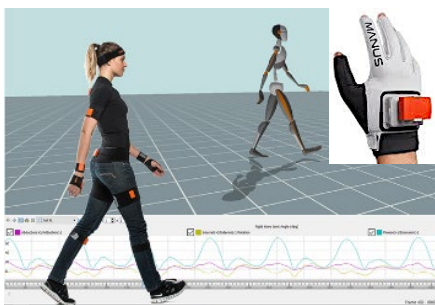

Sensorics, hardware and software for ergonomic analysis of the collaborative workplace: **Xsens MVN Human Motion Measurement Movella Inc. USA**, sensor gloves **Manus gloves for Xsens-edition Manus Netherlands**. The 17-sensors suit captures movements, generates data and transmits them to the software for processing for ergonomic studies, optimisation of work performance, etc. The sensor gloves are fully integrated into the Xsens' motion capture software, which allows us to capture real-time data on the movement of the fingers of the hand.



Intelligent system for time study and setting time standards of collaborative workplaces **DRIGUS Drigus Systeme GmbH, Germany**. The system contains a MULTIDATA recording device (for capturing time data when recording workplaces) and MEZA, PLAZET, MULTI software for processing of recordings. The time study is based on the REFA method.



Software for the Time and Work Study **Normar Pisk, d. o. o., Slovenia**. The system for time study consists of recording time according to the REFA method with the determination of time standards, continuous stopwatch time study, and study of working time performance according to the work sampling method.



#### VR/AR hardware: Oculus Rift and Oculus Go Oculus VR USA and HTC Vive Pro HTC Corp.Taiwan

The Virtual and Augmented Reality equipment includes a series of sensors and algorithms that track the motion of the user's head and hands, enabling an immersive 3D experience in the work environment.



#### Equipment for the design and optimisation of smart factories

Software: Siemens PLM Software package, Autodesk Factory Design Suite, Plant Simulation package, LEKIN scheduling system, MS Project.

#### SERVICE OFFER AND SUPPORT TO THE ECONOMY

- Determination of the structure of working time (losses), time study.
- Ergonomic Workplace Studies.
- Development of collaborative workplaces.
- Optimisation of production planning and control, development of the scheduling system.
- Optimisation of equipment layout.
- Inventory management.
- Project management: solving problems at the strategic and operational levels.

#### COOPERATION WITH RESEARCH AND OTHER INSTITUTIONS

- Faculty of Mechanical Engineering, University of Ljubljana, Ljubljana, Slovenia
- Technische Universität Wien, Vienna, Austria
- Technische Universität Graz, Graz, Austria
- University of Applied Sciences, Karlsruhe, Germany
- Poznan University of Technology (Politechnika Poznanska), Faculty of Engineering Management, Poznan, Poland
- Estonian University of Life Sciences, Biosystems Engineering, Tartu, Estonia
- University of Southern Denmark, Mads Clausen Institute and Institute for Marketing & Management, Denmark
- Technical University of Košice, Košice, Slovakia
- University of Girona, Polytechnics School, Department of Business Administration and Product Design, Girona, Spain
- Faculty of Technical Sciences, University of Novi Sad, Novi Sad, Serbia
- Faculty of Mechanical Engineering and Naval Architecture, University of Zagreb, Zagreb, Croatia
- Faculty of Mechanical Engineering, University of Slavonski Brod, Slavonski Brod, Croatia
- Faculty of Economics, University of Zagreb, Zagreb, Croatia
- Leeds University, Business School, Leeds, United Kingdom
- Fraunhofer ISI, Karlsruhe, Germany
- Austrian Institute of Technology, Vienna, Austria

#### COOPERATION WITH COMPANIES

Siemens, A.G., Munich, Germany, DRIGUS Systeme GmbH, Dortmund, Germany, PISK, d.o.o., Maribor, Slovenia,

LEK, d.d., Ljubljana, Slovenia, Scara-Tec, d.o.o., Hajdina, Slovenia, Plastika Skaza, d.o.o., Velenje, Slovenia, Lean rešitve, d.o.o., Celje, Slovenia, Hella Saturnus Slovenija, d.o.o., Ljubljana, Slovenia, Mik Celje, d.o.o., Celje, Slovenia, Seco Tools Si, d.o.o., Pesnica, Slovenia.

### MOST IMPORTANT RESEARCH ACHIEVEMENT

Backshoring has gained a lot of attention in political debates and academic research in recent years. **The research presents empirical evidence from a large sample of European manufacturing companies.** The data show that backshoring is relatively rare among European companies. The most common reasons are loss of flexibility, poor quality of goods produced abroad, and unused capacity at home. It is prevalent in high-tech sectors, especially in electrical equipment, information and communication equipment and the automotive industry.

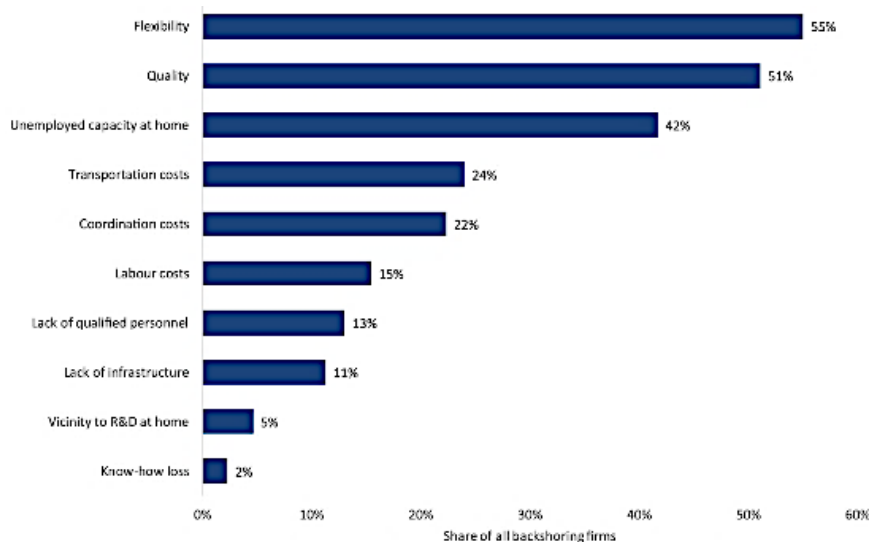

### PUBLICATIONS

1. ZHANG, Hankun, BUCHMEISTER, Borut, LI, Xueyan, OJSTERŠEK, Robert. An efficient metaheuristic algorithm for job shop scheduling in a dynamic environment. *Mathematics*. 2023, vol. 11, iss. 10, [article no.] 2336, str. 24. ISSN 2227-7390. <https://dk.um.si/lzpisGradiva.php?id=84308>, DOI: 10.3390/math11102336. [COBISS. SI-ID 152528131], [JCR, SNIP, WoS].
2. LERHER, Tone, FICKO, Mirko, PALČIČ, Iztok. Throughput performance analysis of automated vehicle storage and retrieval systems with multiple-tier shuttle vehicles. *Applied Mathematical Modelling*. [Print ed.]. Mar. 2021, vol. 91, str. 1004–1022, ilustr. ISSN 0307-904X. DOI: 10.1016/j.apm.2020.10.032. [COBISS. SI-ID 36277251], [JCR, SNIP, WoS].
3. ŠEBO, Juraj, ŠEBOVÁ, Miriam, PALČIČ, Iztok. Implementation of circular economy technologies: An empirical study of Slovak and Slovenian manufacturing companies. *Sustainability*. Nov. 2021, vol. 13, iss. 22 (12518), str. 1–17. ISSN 2071-1050. DOI: 10.3390/su132212518. [COBISS. SI-ID 84952323], [JCR, SNIP, WoS].
4. VUJICA-HERZOG, Nataša, HARIH, Gregor. Decision support system for designing and assigning ergonomic workplaces to workers with disabilities. *Ergonomics*. [Print ed.]. Nov. 2019, vol. 62, iss. 12, str. 1–13, ilustr. ISSN 0014-0139. <https://www.tandfonline.com/doi/full/10.1080/00140139.2019.1686658?scroll=top&needAccess=true>, DOI:10.1080/00140139.2019.1686658. [COBISS. SI-ID 22759190], [JCR, SNIP, WoS].
5. DACHS, Bernhard, KINKEL, Steffen, JÄGER, Angela, PALČIČ, Iztok. Backshoring of production activities in European manufacturing. *Journal of Purchasing and Supply Management*. [Print ed.]. June 2019, vol. 25, iss 3 (100531), str. 1–16. ISSN 1478-4092. DOI: 10.1016/j.pursup.2019.02.003. [COBISS. SI-ID 22168342], [JCR, SNIP, WoS].

### ARIS RESEARCH PROGRAMME

P2-0190 Advanced Concepts of Production Management and Dimensional Metrology

### NATIONAL AND INTERNATIONAL PROJECTS

- Ergonomic workplace design for workers with disabilities and their long-term employment ERGOART. Erasmus+ 2023-1-SI01-KA220-HED-000166987, 1.9.2023 - 28.2.2026.
- European Manufacturing Survey. Koordinator Fraunhofer Institute, ISI, Karlsruhe, 2021 - 2024.
- Management of production with a primary focus on organising employees in production. LEK pharmaceutical company, d.d., 30.01.2022 - 30.7.2023.

- Scientific research cooperation between the Republic of Slovenia and the Federal Republic of Germany, ARIS, 1.1.2023 - 31.12.2024.
- Smart Shelters by Scara. Scara-Tec d. o. o., 1.6.2023.
- Readiness of Slovenian and Serbian manufacturing companies for Industry 4.0. Cooperation between the Republic of Slovenia and the Republic of Serbia, 2020 - 2022.
- Digitalisation of manufacturing companies in Austria and Slovenia. Cooperation between the Republic of Slovenia and the Republic of Austria, 2018 - 2019.
- Analysis of the characteristics of the Slovenian manufacturing industry. Lean Solutions, d.o.o., 2020.

#### MEMBERSHIPS

- DAAAM International – Danube Adria Association for Automation & Manufacturing, Vienna, Austria
- INFORMS - Institute for Operations Research and the Management Sciences, Catonsville, USA
- EurOMA - European Operations Management Association, United Kingdom
- AIM - European Academy of Industrial Management, Ghent, Belgium

#### 5.5 LABORATORY FOR MACHINING PROCESSES



*Head of the Laboratory*

**Assoc. Prof. Simon Klančnik**

E-mail: [simon.klančnik@um.si](mailto:simon.klančnik@um.si)

Tel: +386 2 220 7601

Web: <https://www.fs.um.si/laboratorij-za-odrezavanje/>

The laboratory enables in-depth scientific research and development work in the field of machining systems and processes thanks to its excellent personnel and infrastructure structure. We are focused on development and innovation in the fields of digitalisation of production, machine vision in production, and the integration of artificial intelligence into production processes. The laboratory combines pedagogical work at all levels of study with intensive research work, which enables students to be involved practically in the latest projects. Our goal is to develop advanced machine vision techniques and intelligent systems for the optimisation and automation of machining processes, with an emphasis on cutting processes. We pay special attention to the development of advanced production systems and processes in the food processing industry and agriculture, with the aim of creating sustainable and environmentally friendly solutions. We also focus on the monitoring, diagnostics and prognostication of machining systems and processes, predictive analytics and computer simulations of production systems and processes. Our team has extensive knowledge and analytical tools to understand complex production processes, which allows us to develop efficient and innovative solutions in the field of Production, by incorporating advanced technologies and sustainable approaches. In the laboratory, we believe that the key to innovation lies in close cooperation with industry partners and academia, enabling the exchange of knowledge and experience that are the basis for technological progress.

#### MAJOR RESEARCH EQUIPMENT



##### **Machine Vision System Basler, National Instruments, Opto Engineering**

The equipment is intended for laboratory testing of innovative machine vision solutions in smart factories. A powerful telecentric lens and a high-quality homogeneous light source enable precise optical analyses. The captured data are processed on an industrial computer, which, in addition to a powerful processor, enables the use of Field Programmable Gate Arrays (FPGA), which enables the use of computationally very demanding algorithms for digital image processing (including the use of Artificial Intelligence) in real-time applications in production.





### ZOLLER Smile 420 Zoller

The Smile 420 is an advanced measuring and adjustment device designed for accurate and efficient measurement and tool pre-setting. It is used mainly in industrial environments, where high precision and speed are required in the processing of metals and other materials. The device allows you to measure the length, diameter, radius, angle and other parameters of the tools accurately, which ensures optimal preparation of tools for the production process.

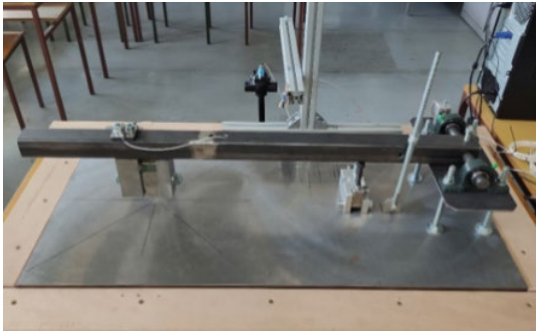

### Measuring equipment for the control of PCB machining and forming processes

The measuring equipment is designed to analyse the straightening process of high-hardness metal workpieces. The system includes an industrial microphone to capture the acoustic response, a force sensor, an accelerometer, a position indicator, a charge amplifier and an input/output card. The equipment enables precise monitoring and optimisation of the straightening process, which contributes to better workpiece quality and production efficiency.

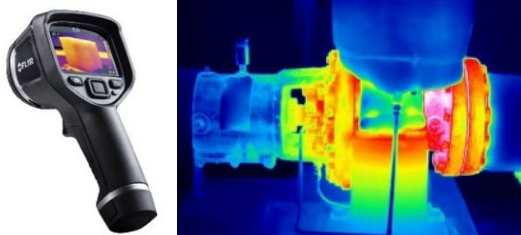

### Thermocamera FLIR A5 Teledyne FLIR

The thermal camera detects infrared radiation from objects, which makes it possible to display the temperature distribution in the image. The device is crucial in the analysis of cutting processes, as it allows the monitoring of temperature changes during the processing of materials, which is important for optimising processes and extending the life of tools. The main advantage of using a thermal imaging camera is the quick and easy detection of hidden defects, which can avoid lengthy inspection procedures. Faults can be detected before equipment failures or other types of losses occur, enabling efficient predictive maintenance and optimisation of industrial processes.

## SERVICE OFFER AND SUPPORT TO THE ECONOMY

- Development and optimisation of machining processes with an emphasis on cutting processes.
- Monitoring, diagnostics and prognostication of machining systems: introduction of advanced monitoring systems for monitoring and analysis of processes; diagnostic services to identify problems in production processes; predictive analyses to predict problems and improve maintenance.
- Implementation of Machine Vision in production processes: the development and integration of machine vision systems for automation and quality control.
- Predictive analytics: the use of advanced analytical tools to predict trends and optimise production.
- Computer simulations: CAM simulations; Development of customised SIMULINK simulations.
- Development of dedicated software solutions: Matlab, Labview, Python.
- Optimisation of production systems and processes: services to increase efficiency and reduce the cost of production processes.
- Use of Artificial Intelligence in manufacturing: the implementation of AI solutions to automate, improve quality and increase productivity.
- Development of advanced production systems for the food processing industry and agriculture: specific solutions for process optimisation in the food industry and agriculture.
- Separation technologies in production processes: the development and implementation of optical sorters to improve production efficiency.

- Application of thermography in machining processes: thermographic analysis services to control and improve production processes; development of advanced analysis of data captured by the IR camera.

#### COOPERATION WITH RESEARCH AND OTHER INSTITUTIONS

- Faculty of Pharmacy, University of Ljubljana, Ljubljana, Slovenia
- Faculty of Mechanical Engineering, University of Ljubljana, Ljubljana, Slovenia
- Faculty of Polymer Technology, Slovenj Gradec, Slovenia
- Rudolf – Science and Technology Centre Novo mesto, Novo mesto, Slovenia
- Graz University of Technology, Graz, Austria
- University of Belgrade, Belgrade, Serbia
- University of Novi Sad, Novi Sad, Serbia
- University of Sarajevo, Sarajevo, Serbia
- University of Rijeka, Rijeka, Croatia
- Faculty of Agriculture and Life Sciences, Maribor, Slovenia
- Faculty of Electrical Engineering, Computer Science and Informatics, Maribor, Slovenia
- Institute of Hop Growing and Brewing of Slovenia, Žalec, Slovenia
- Polytechnic University of Madrid, Madrid, Spain
- Catholic University of Leuven, Leuven, Belgium
- Mediterranean University Podgorica, Podgorica, Montenegro

#### COOPERATION WITH COMPANIES

Plastika SKAZA, d.o.o., SIJ Ravne Systems, d.o.o., VISION, d.o.o., Peter Lepej, s.p., AVL-AST, d.o.o., Turna, d.o.o., EMO orodjarna, d.o.o., SEVEN REFRACTORIES, d.o.o., Innoduler, d.o.o., KOM, d.o.o., Interkorn, d.o.o.

#### PUBLICATIONS

1. DVORŠEK, Nejc, STOPEINIG, Iztok, KLANČNIK, Simon. Optimization of chaboche material parameters with a genetic algorithm. *Materials*. Feb. 2023, vol. 16, iss. 5, [article no.] 1821, str. 14. ISSN 1996-1944. DOI: 10.3390/ma16051821.
2. PERŠAK, Tadej, HERNAVS, Jernej, VUHERER, Tomaž, BELŠAK, Aleš, KLANČNIK, Simon. Prediction of the form of a hardened metal workpiece during the straightening process. *Sustainability*. April 2023, vol. 15, iss. 8, [article no.] 6408, str. 1–19. ISSN 2071-1050. DOI: 10.3390/su15086408.
3. FICKO, Mirko, BEGIĆ-HAJDAREVIĆ, Đerzija, COHODAR HUSIC, Maida, BERUS, Lucijano, ČEKIĆ, Ahmet, KLANČNIK, Simon. Prediction of surface roughness of an abrasive water jet cut using an artificial neural network. *Materials*. 5 June 2021, vol. 14, iss. 11, str. 1–16. ISSN 1996-1944. DOI: 10.3390/ma14113108.
4. BRILI, Nika, FICKO, Mirko, KLANČNIK, Simon. Automatic Identification of tool wear based on thermography and a convolutional neural network during the turning process. *Sensors*. 9. Mar. 2021, vol. 21, iss. 5, str. 1–17. ISSN 1424-8220. DOI: 10.3390/s21051917.
5. SAVKOVIČ, Borislav, KOVAČ, Pavel, RODIČ, D., STRBAC, Branko, KLANČNIK, Simon. Comparison of artificial neural network, fuzzy logic and genetic algorithm for cutting temperature and surface roughness prediction during the face milling process. *Advances in production engineering & management*. June 2020, vol. 15, no. 2, str. 137–150, ilustr. ISSN 1854-6250. DOI: 10.14743/apem2020.2.354.

#### PATENTS AND PATENT APPLICATIONS

- PERŠAK, Tadej, HERNAVS, Jernej, KLANČNIK, Simon. A system and a method for machine-assisted straightening of hardened metal workpieces: EP23167177, 2023-04-06. Munich (Germany): European Patent Office, 2023.
- PERŠAK, Tadej, KLANČNIK, Simon, VILTUŽNIK, Branka. Device for sorting transparent, loose material and the process of classifying particles of the said material: Patent application No. P-201800266 dated 11.12.2018. Ljubljana: Intellectual Property Office of the Republic of Slovenia, 2019.

#### MOST IMPORTANT RESEARCH ACHIEVEMENT

**Development of predictive analysis of the straightening of high-hardness metal workpieces using Deep Neural Networks.**

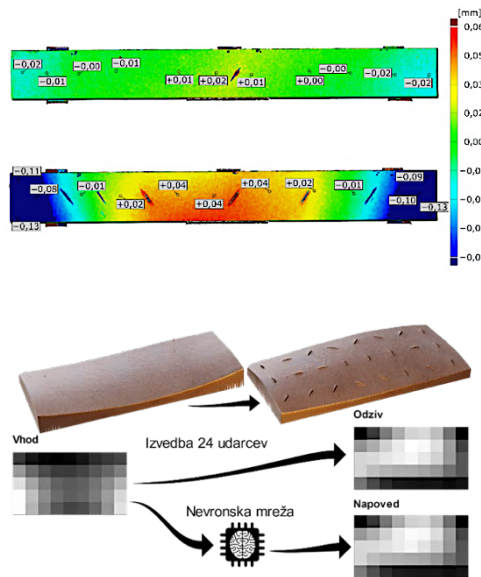
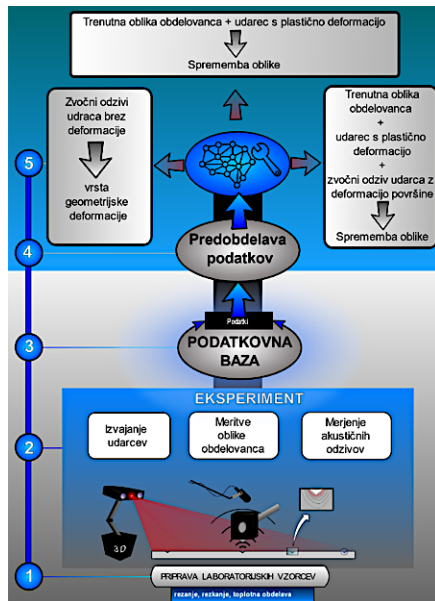

## ARIS RESEARCH PROGRAMME P2-0157 Technological Systems for Smart Manufacturing

### NATIONAL AND INTERNATIONAL PROJECTS

- Cognitive geometric control of mechanically processed forgings based on mass data from the machining process. ARIS project L2-3167, 1/10/2021-3/9/2024
- Sustainable plant protection through the introduction of UV lighting. EIP project, 18/05/2023-19/05/2025
- Development of control algorithms and systems to prevent the harmful consequences of COVID-19 in production systems. Bilateral project BI-BA/21-23-036, 2021–2023.
- Unconventional Processing Methods: Optimization of Processing Parameters Using Artificial Intelligence Methods. Bilateral project BI-BA/16-17-034, 2016–2017.
- Development of advanced tool steel for the most demanding applications in the industry. RRI project C3330-18-952004, 01/09/2018-31/08/2021
- Development of a new technological process to produce complex products made of transparent polycarbonate with at least a 50% share of secondary waste raw material for applications in the furniture and electrical industries. An RRI2 project, 2017-2018

### MEMBERSHIPS

- KAZU - Carinthian Academy of Sciences and Arts

## 5.6 LABORATORY FOR OIL HYDRAULICS



Head of the Laboratory

**Prof. Darko Lovrec**

E-mail: [darko.lovrec@um.si](mailto:darko.lovrec@um.si)

Phone: +386 2 220 7611

Web: [laoh.fs.um.si](http://laoh.fs.um.si)

The Laboratory for Oil Hydraulics focuses on R&D, professional and pedagogical work in the field of Hydraulic and pneumatic drive and control systems and automation of machines and devices, including the concepts of Industry 4.0. Project activities include the use of classical and modern electro-hydraulic drive technology, signal acquisition, their processing and condition monitoring of hydraulic components and entire drive assemblies. We develop simple and purpose-built advanced electro-hydraulic linear and rotary drives, using classic and modern control structures, to increase precision, dynamics and energy efficiency.

Special emphasis is placed on on-line condition monitoring of hydraulic fluid and the development of high-tech, non-flammable and environmentally friendly hydraulic fluids, especially ionic hydraulic fluids, which have exceptional physicochemical properties. These fluids are developed for use in special and demanding operating conditions, which contributes to improving the efficiency and safety of hydraulic systems. We incorporate the latest findings in various projects for industrial partners, and, through various trainings courses in the field of Hydraulics, Pneumatics and the care and monitoring of hydraulic fluids and industrial lubricants, we offer them comprehensive knowledge in this field in the form of supplementary and lifelong education.

## MAJOR RESEARCH EQUIPMENT



### I4.0 cyber-physical development system with eight FESTO GmbH workstations

The CP Lab I4.0 with eight independently operating work units, assembled arbitrarily into a larger production system, is a modern cyber-physical flexible development production system. The modularly built system enables research related to the control of processes in real time and space, recording, monitoring and analysis of data related to processing and to the machine, and ensuring the smooth operation of the system, also through a virtual copy of the real system.



### Hydraulic power unit with on-line monitoring of all operating parameters In-house design and construction

The hydraulic power unit is a modernly designed drive unit with two drive trains, which enables various research related to the dynamics and energy efficiency of drive combinations: from classic versions with adjustable pumps to speed-controlled adjustable pumps. In addition to monitoring all the important operating parameters of the system, both on-site and remotely, the system also includes on-line monitoring of the built-in hydraulic fluid, with the possibility of predicting its remaining useful life, with the possibility of predicting its remaining useful life.

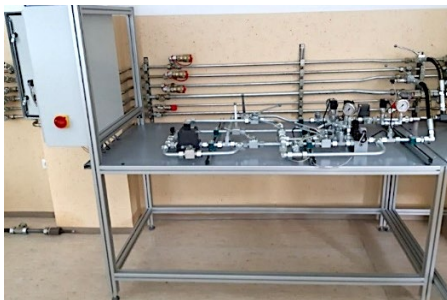

### Device for measuring the characteristics of continuously operating valves In-house design and construction

The device enables automated measurement of the static and dynamic characteristics of electrohydraulic continuously operating proportional valves and servo valves of NG 6 size. The measurement of characteristics is carried out in accordance with the ISO 10770-1 Standard, and includes an internal leak test, flow-input signal characteristic, pressure drop over the steering edge, and others. Based on the measured characteristics, it is also possible to select valves with identical characteristics selectively.



### Two-axis electro-hydraulic test device In-house design and construction.

The flexibly designed two-axis electro-hydraulic test device is designed for single- and two-axis long-term testing of materials and small assemblies and is suitable for testing and research in the fields of Durability and Fracture Mechanics. Loading of different test subjects is possible, both by position and by force. The device consists of a stable frame with two servo-hydraulic cylinders, which enable the achievement of appropriate dynamics and load profile. The system is controlled by an electronic control with a built-in Beckhoff multi-core controller, which, simultaneously runs the control program and the human-machine interface in real time and includes the storage of all data. With the test device, it is possible to achieve forces of up to 40 kN at a frequency of up to 20 Hz.



### SERVICE OFFER AND SUPPORT TO THE ECONOMY

- Various studies and solutions in the field of hydraulic drive technology.
- Design and development of small assemblies with a hydraulic drive.
- Design and maintenance of on-line monitoring systems of hydraulic devices and fluids.
- Design of modern electro-hydraulic drive axles.
- Standard and dedicated training courses for participants from industry - in the field of hydraulics, pneumatics, lubricants.

### COOPERATION WITH RESEARCH AND OTHER INSTITUTIONS

- Graz University of Technology, Graz, Austria
- JKU - Johannes Kepler University Linz, Austria
- IFAS - Institute of Fluid Power Drives and Systems, RWTH Aachen University, Aachen, Germany
- Technical University of Dresden, Dresden, Germany
- FSB Zagreb, Zagreb, Croatia
- Faculty of Mechanical Engineering, University of Ljubljana, Ljubljana, Slovenia
- Proionic GmbH, Graz, Austria
- Mettop GmbH, Leoben, Austria

### COOPERATION WITH COMPANIES

OLMA, d.o.o., Ljubljana, proionic GmbH, Graz, Austria, HAWE Hydraulics, d.o.o., Štore, Mettop GmbH, Leoben, Austria, La&Co, d.o.o., Maribor, Poclairn Hydraulics, d.o.o., Žiri, Beckhoff Avtomatizacija, d.o.o., Medvode, TESNILA BOGADI, d.o.o., Maribor, FESTO Ljubljana, d.o.o., Ljubljana, DEM - Dravske elektrarne Maribor, Maribor, SIJ ACRONI, d.o.o., Jesenice, IMPOL, d.o.o., Slov. Bistrica, Goodyear Dunlop - SAVA Tires, d.o.o., Kranj, PANOLIN International Inc., Švica, Plastenka, d.o.o., Radomlje, Paloma, d.d., Sladki vrh, AD Vita, d.o.o., etc.

### MOST IMPORTANT RESEARCH ACHIEVEMENT

**The modern electro-hydraulic linear axis** in the lightweight construction version has an **integrated hydraulic-control** drive assembly and is designed for demanding conditions of use in the field of Metallurgy. The hydraulic cylinder, with integrated safety control unit and electronic control, is driven directly by a speed-controlled constant hydraulic pump. The advantage of such a design is a small amount of hydraulic fluid and a closed system, isolated from the specific operating environment. A high-tech ionic hydraulic fluid is used as the hydraulic fluid, the result of our own long-term development with Austrian partners.

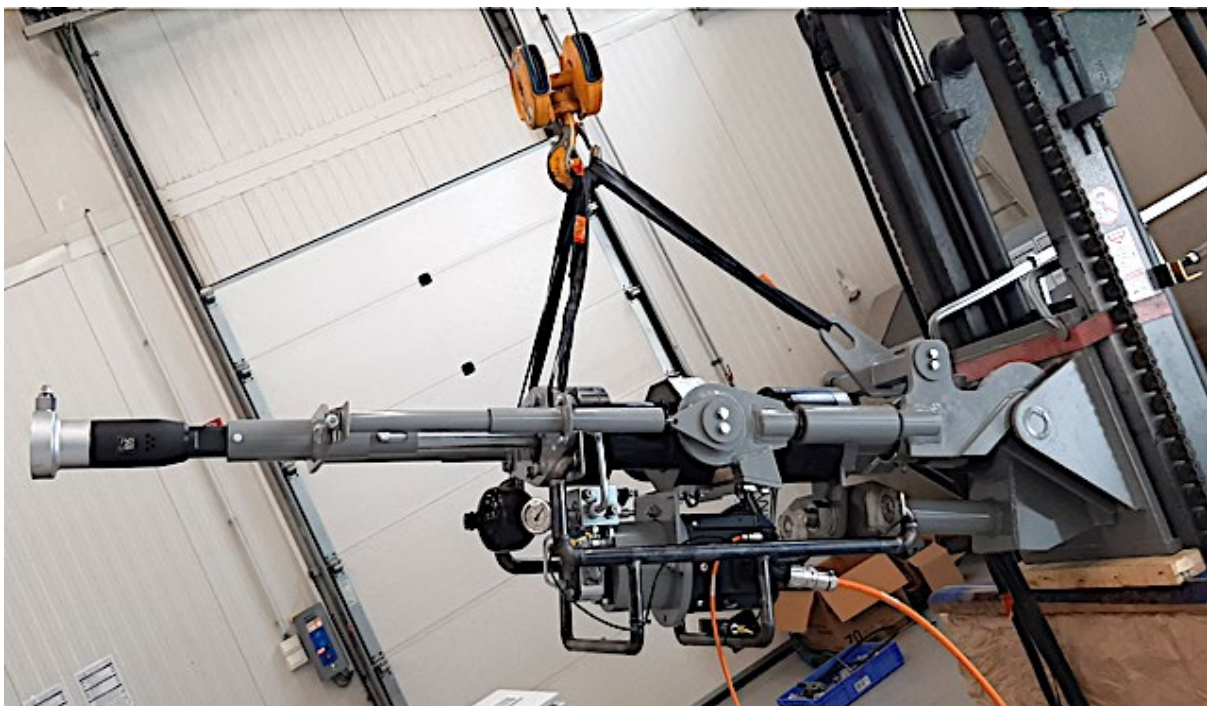



## PUBLICATIONS

1. LOVREC, Darko, KALB, Roland, TIČ, Vito. *Application areas of ionic hydraulic fluids*. *Chemical Engineering & Technology*. January 2023, vol. 46, iss. 1, str. 14–20. ISSN 1521-4125. DOI: 10.1002/ceat.202200368.
2. LOVREC, Darko, TIČ, Vito. *The importance of the electrical properties of hydraulic fluids*. *Industrial Lubrication and Tribology*. [Print ed.]. March 2022, vol. 74, iss. 3, str. 302–308. ISSN 0036-8792. DOI: 10.1108/ILT-06-2021-0218. [COBISS. SI-ID 84091651].
3. TIČ, Vito, ROTOVNIK, Andraž, LOVREC, Darko. *Impact of proportional valves' differences to ensure uniform motion of hydraulic motors*. *International Journal of Simulation Modelling*. Mar. 2021, vol. 20, no. 1, str. 52–63. ISSN 1726-4529. DOI: 10.2507/IJSIMM20-1-540. [COBISS. SI-ID 54440195].
4. EDLER, Jörg, LOVREC, Darko, TIČ, Vito. *1-D simulation model of a progressive flow controller for hydrostatic bearings*. *International Journal of Simulation Modelling*. June 2019, vol. 18, no. 2, str. 267–278. ISSN 1726.
5. KAMBIČ, Milan, KALB, Roland, TIČ, Vito, LOVREC, Darko. *Compatibility of ionic liquids with hydraulic system components*. *Advances in production engineering & management*. Dec. 2018, vol. 13, no. 4, str. 492–503, ilustr. ISSN 1854-6250. <http://www.dlib.si/details/URN:NBN:SI:doc-GXD7QGUX>, DOI: 10.14743/apem2018.4.306. [COBISS. SI-ID 21990678].

## ARIS RESEARCH PROGRAMME P2-0157 Technological Systems for Smart Manufacturing

### NATIONAL AND INTERNATIONAL PROJECTS

- Implementation of a modern approach to the maintenance of hydraulic systems on PS 04, PS05 and PS09 paper machines in the Paloma company. Report on the inspection of the condition of the PS04 AND PS09 hydraulic systems and suggestions for upgrading the systems. Order No. DOS92000386, Client IMPOL.
- Comparative testing of turbine oils. Order No. NR15-0034. Client of the Drava Power Plant Maribor.
- Determination of limit values for the use of mineral and biodegradable oil for the operation of aggregates on DEM M - C – P. DEM. Client DEM - Dravske elektrarne Maribor, 2012-2013.
- Comparative test of Turwada Synth 68 = Repetition test of Turwada Synth 68. PANOLIN Turwada Synth 68. Client Panolin.
- Evaluation of hydraulic gear pump performance and durability using IL- B2002a. PN PROIONIC: ISIS2HYD\_2: PN UNI-MB: P-075-225/2020-KPS, Naročnik Proionic GmbH, Austria.
- Evaluation of the high temperature cooling liquid ISIS-B2002a as a fire-resistant hydraulic medium. Project ISIS2HYD. Test devices and test procedures for testing the impact of IL on hydraulic components. Naročnik proionic GmbH, Austria.
- Evaluation of the high temperature cooling liquid ISIS-B2002a as a fire-resistant hydraulic medium. Project ISIS2HYD. Test results - impact of IL on hydraulic components: B2002a vs. Oil. Naročnik Proionic GmbH, Austria.
- Evaluation of the high temperature cooling liquid ISIS-B2002a as fire resistant hydraulic medium. Project ISIS2HYD. Seal compatibility test with different ILs and mineral based hydraulic oil. Naročnik Proionic GmbH, Avstrija.
- Evaluation of the high temperature cooling liquid ISIS-B2001 as a fire-resistant hydraulic medium. Project ISIS2HYD. Pump pulsation using high bulk modulus ionic liquids (IL-B2001, EMIM-EtSO4) and mineral hydraulic oil HLP VG 32. Naročnik Proionic GmbH, Austria.
- TOMA-x and SNC based ionic liquids: H.O.P.E. Hawe-Olma-Proionic-Engineering. Naročnik Proionic GmbH, Austria.

### MEMBERSHIPS

- CETOP - European Hydraulic and Pneumatic Association
- FTS - Slovenian Fluid Power Association
- SDFT - Slovenian Society for Fluid Power Technology
- ZSIS - Association of Mechanical Engineers of Slovenia

## 5.7 LABORATORY FOR FLEXIBLE MANUFACTURING SYSTEMS



Head of the Laboratory

**Assoc. Prof. Mirko Ficko**

Email: [mirko.ficko@um.si](mailto:mirko.ficko@um.si)

Tel.: +386 2 220 7595

Web: <https://www.fs.um.si/laboratorij-za-prilagodljive-obdelovalne-sisteme/>

The Laboratory for Flexible Manufacturing Systems is focused on the development of machining technologies and devices for modern manufacturing. The research it conducts includes testing and performing measurements in the field of technological processes. The laboratory develops prototypes and non-standard products in small batches; It offers complete solutions, from construction and fabrication to final assembly and testing. The prototype workshop is complemented by computer-aided processing with turning and five-axis milling, as well as laser cutting and bending of sheet metal. The laboratory develops and improves existing technologies for the challenges of modern industry.

### MAJOR RESEARCH EQUIPMENT



#### Five-axis CNC milling machine CV5-500 Mazak

The five-axis CNC milling machine enables high-precision and high-speed simultaneous five-axis milling of workpieces, whereby workpieces can be processed up to 500 mm in diameter and 320 mm in height.



#### Three-axis CNC lathe with driven tools Lynx 220LMA Doosan

The three-axis CNC lathe enables turning of workpieces up to a diameter of 250 mm and a length of 510 mm. Milling and drilling operations can also be performed on the lathe, as the turret is equipped with live tools, and CAM programming is also enabled.



#### Four-axis CNC sheet metal bending machine TruBend 3066 (B26) Trumpf

The machine has a working length of sheet metal bending of 2040 mm and allows a thrust force of 660 kN. It is equipped with a modern controller that allows you to simulate sheet metal bending using a digital twin. An ACB laser is used for automatic angle measurement and real-time compensation of elastic alignment, and the precise achievement of the position of the sheet before bending is enabled by a 4-axis rear support system, which also allows the connection of an industrial robot.



#### CNC Surface Laser Cutting Machine Bodor i7 Bodor

The machine is designed for laser cutting of sheet metal, whereby a wide range of steel types (including stainless steel) and other materials (e.g., aluminium and brass) can be cut. It is equipped with an ytterbium fibre laser beam source with a power of 3 kW and a working space of 3048 x 1524 mm<sup>2</sup>. The thickness of the sheet metal cutting depends on the type of material and the cutting gas used, and nitrogen and oxygen can be used for the cutting gas.

## SERVICE OFFER AND SUPPORT TO THE ECONOMY

- Implementation of CNC courses for companies.

## COOPERATION WITH RESEARCH AND OTHER INSTITUTIONS

- Graz University of Technology, Graz, Austria
- University of Novi Sad, Faculty of Technical Sciences, Novi Sad, Serbia
- University of Sarajevo, Faculty of Mechanical Engineering, Sarajevo, Bosnia and Herzegovina
- Campus 02, Graz University of Applied Sciences, Graz, Austria

## COOPERATION WITH COMPANIES

Var, d.o.o., Talum, d.o.o., Emo orodjarna, d.o.o.

## MOST IMPORTANT RESEARCH ACHIEVEMENT

### Analysis of the processing capacity of aluminium foams by cutting and incremental transformation processes.

Mechanical processing tests were performed of turning, milling, drilling and single-point incremental forming of aluminium foam samples. The influence of machining parameters on the porosity of the treated surface was determined with the help of the method of responsive surfaces. From the test results, it was found that the number of revolutions has the maximum and the feed velocity the least effect on the reduction of surface porosity.

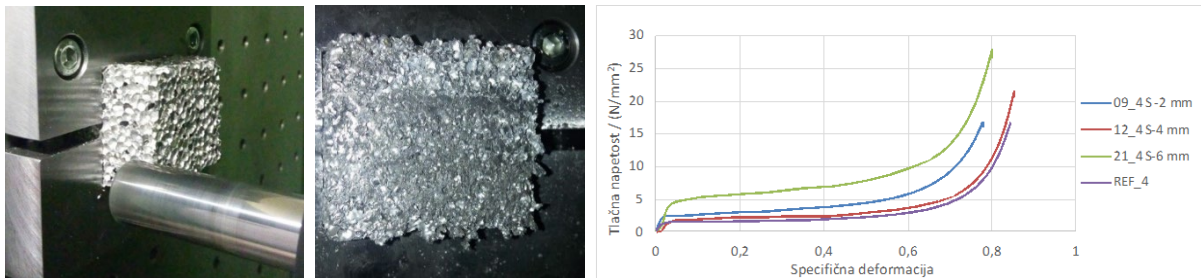

Incremental transformation of aluminium foam

Pressure Diagram of Foamtech Aluminium Foam Sample Testing

The compressive properties of the treated samples, whose surface porosity was reduced due to surface deformation, increased significantly. It has been established that the thickness of the deformed surface depends on the transforming properties of the material of aluminium foams. It has been established and proven that elements manufactured by material removal processes can increase compressive strength and reduce notching effects by subsequent transformation processes such as incremental transformation and friction rolling. Such a combination of machining processes, which can be carried out on the same machine, makes sense to use in small-scale production of products.

## PUBLICATIONS

- FICKO, Mirko, BEGIĆ-HAJDAREVIĆ, Đerzija, COHODAR HUSIC, Maida, BERUS, Lucijano, ČEKIĆ, Ahmet, KLANČNIK, Simon. Prediction of surface roughness of an abrasive water jet cut using an artificial neural network. *Materials*, ISSN 1996–1944, 5 June 2021, vol. 14, iss. 11, str. 1–16, doi: 10.3390/ma14113108. [COBISS. SI-ID 66209795].
- RAZBORŠEK, Boštjan, GOTLIH, Janez, KARNER, Timi, FICKO, Mirko. The influence of machining parameters on the surface porosity of a closed-cell aluminium foam. *Strojniški vestnik*, ISSN 0039-2480, Jan. 2020, vol. 66, no. 1, str. 29–37, SI 5, ilustr. <https://www.sv-jme.eu/sl/article/the-influence-of-machining-parameters-on-the-surface-porosity-of-a-closed-cell-aluminium-foam/>, doi: 10.5545/sv-jme.2019.6297. [COBISS. SI-ID 17016859].
- MUHAMEDAGIC, Kenan, BERUS, Lucijano, POTOČNIK, David, ČEKIĆ, Ahmet, BEGIĆ-HAJDAREVIĆ, Đerzija, COHODAR HUSIC, Maida, FICKO, Mirko. Effect of process parameters on tensile strength of FDM printed carbon fiber reinforced polyamide parts. *Applied Sciences*, ISSN 2076-3417, June 2022, vol. 12, iss. 12 (6028), str. 19, ilustr., doi: 10.3390/app12126028. [COBISS. SI-ID 112573443].

ARIS RESEARCH PROGRAMME P2-0157 Technological Systems for Smart Manufacturing

## NATIONAL AND INTERNATIONAL PROJECTS

- Cognitive geometric control of mechanically processed forgings based on mass data from the machining process. ARIS project, 1/10/2021-30/09/2024.

## 5.8 LABORATORY FOR ROBOTISATION



*Head of the Laboratory*

**Assis. Prof. Timi Karner**

E-mail: [timi.karner@um.si](mailto:timi.karner@um.si)

Tel: +386 2 220 7722

Web: <https://www.fs.um.si/laboratorij-za-robotizacijo/>

In the laboratory, we focus on the quality education of future mechatronics engineers. Our goal is to enable students to acquire the knowledge and skills they need to design modern robotic industrial cells independently. This includes selecting the appropriate robotic technology, setting up the system, establishing communication, and programming both industrial and collaborative robots safely and successfully. Our work is focused on providing practical experience and developing key skills that enable students to work successfully in an industrial environment. In the laboratory, we focus on pioneering research and implementation of the latest technologies in robotisation and digitalization. Our goal is to encourage innovation and create advanced solutions in robotisation and digitalization that will shape the future of the industry.

### MAJOR RESEARCH EQUIPMENT



#### **Universal Robot UR10e Universal Robots**

Basic specifications: freedom levels: 6, load capacity: 10 kg, reach: 1300 mm, repeatability:  $\pm 0.05$  mm, special feature: no need for a safety fence in certain configurations.



#### **ABB IRB 1200 ABB Ltd**

Basic specifications: freedom levels: 6, load capacity: 5 kg, reach: 901 mm, repeatability:  $\pm 0.02$  mm.



#### **KUKA KRC4 KR16-2 Kuka AG**

Basic specifications: Degrees of liberty: 6, load capacity: 16 kg, reach: 1612 mm, repeatability:  $\pm 0.04$  mm.



#### **KUKA KRC1 KR15-2 Kuka AG**

Basic specifications: freedom levels: 6, load capacity: 15 kg, reach: 1570 mm, repeatability:  $\pm 0.1$  mm.



**ACMA XR701 ABB Ltd**

Basic specifications: freedom levels: 6, load capacity: 160 kg, reach: 2800 mm, repeatability: ± 0.3 mm.

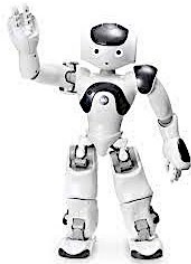

**Humanoid robot NAO SoftBank Robotics**

Basic specifications: 26 levels of freedom, 7 touch sensors, 4 microphones and speakers for interaction, a 2D camera.

**SERVICE OFFER AND SUPPORT TO THE ECONOMY**

- Training for companies in programming, selection and "offline" programming of industrial robots, which are mentioned above.
- Consulting in the selection and integration of industrial robots into the production process.
- Digital twins: creating digital twins of systems in the development phase, where we can test the system at an early stage of digital development and predict problematic factors in the realization of the physical system, or the representation of physical products, where the already functioning system is reconstructed for the purpose of understanding the operation and easier upgrades. In one digital twin, you can:
  - prepare a 3D model of the cell considering the physical properties - *SIEMENS NX - MCD*,
  - create a control algorithm for a programmable logic controller (PLK) - *SIEMENS TIA + WinCC*,
  - simulate the real implementation of the controller – *S7-PLCSIM*,
  - simulate the responses of electro-mechanical elements such as motors, etc. - *SIEMENS SIMIT*,
  - create a robotic guidance algorithm (a program dependent on the robot).

**COOPERATION WITH COMPANIES**

SMM Proizvodni sistemi, d.o.o., BNM, d.o.o., Goldpack, d.o.o., Dewesoft, d.o.o., Unior, d.d., Gorenje, d.d.

**MOST IMPORTANT RESEARCH ACHIEVEMENT**

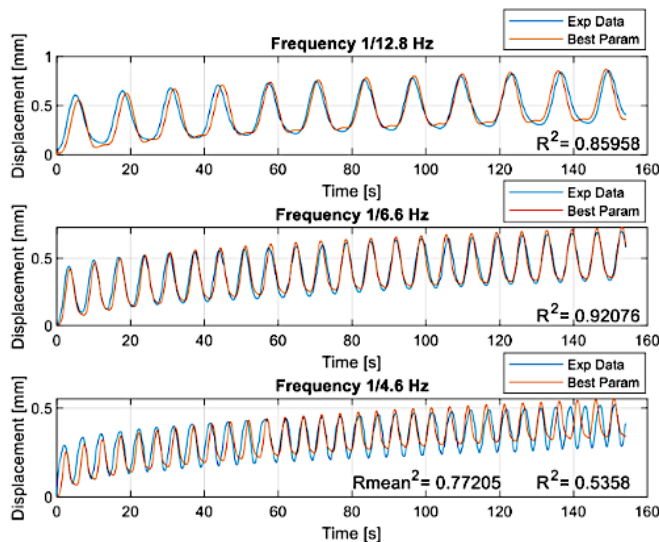

Dielectric elastomeric actuators (DEAs) are representatives of soft actuators in the field of soft robotics. They work on the principle of the structure of a parallel capacitor. Between the two conductive elastic electrodes is an elastomer that has nonlinear characteristics. With the use of fractional derivatives and the Laplace transform to obtain a material model, **the sinusoidal response of a soft actuator to a sinusoidally excited high-voltage DC voltage was successfully simulated.**



## PUBLICATIONS

1. KARNER, Timi, BELŠAK, Rok, GOTLIH, Janez. Using a fully fractional generalised maxwell model for describing the time dependent sinusoidal creep of a dielectric elastomer actuator. *Fractal and fractional*, ISSN 2504-3110, Dec. 2022, vol. 6, iss. 12, str. 1–14, doi: 10.3390/fractalfract6120720. [COBISS. SI-ID 133569027]
2. GOTLIH, Janez, BREZOČNIK, Miran, PAL, Snehashis, DRSTVENŠEK, Igor, KARNER, Timi, BRAJLIH, Tomaž. A holistic approach to cooling system selection and injection molding process optimization based on non-dominated sorting. *Polymers*, ISSN 2073-4360, Nov. 2022, vol. 14, iss. 22 (4842), str. 1–23, ilustr., doi: 10.3390/polym14224842. [COBISS. SI-ID 132370691]
3. KARNER, Timi, GOTLIH, Janez. Position control of the dielectric elastomer actuator based on fractional derivatives in modelling and control. *Actuators*, ISSN 2076-0825. [Online ed.], 2021, vol. 10, iss. 1, str. 1–19, ilustr., doi: 10.3390/act10010018. [COBISS. SI-ID 47889155]
4. GOTLIH, Janez, BREZOČNIK, Miran, KARNER, Timi. Stiffness-based cell setup optimization for robotic deburring with a rotary table. *Applied Sciences*, ISSN 2076-3417, Sep. 2021, vol. 11, iss. 17 (8213), str. 1–17, ilustr. <https://www.mdpi.com/2076-3417/11/17/8213>, doi: 10.3390/app11178213. [COBISS. SI-ID 75283459]
5. KARNER, Timi, GOTLIH, Janez. Viscoelastic constitutive models and their fractional representatives to capture the time-dependent response of DEAs on sinus excitation. *Smart Materials and Structures*, ISSN 0964-1726. [Print ed.], Accepted Manuscript online 9 July 2021, str. 1–22. <https://iopscience.iop.org/article/10.1088/1361-665X/ac1305>, doi: 10.1088/1361-665X/ac1305. [COBISS. SI-ID 69936643]

## ARIS RESEARCH PROGRAMME P2-0157 Technological Systems for Smart Manufacturing

### NATIONAL AND INTERNATIONAL PROJECTS

- ROBKONCEL: Intelligent system for comprehensive quality control in production with a reconfigurable robotic cell and an intelligent process control system 01.09.2018 - 31.08.2021.

## 5.9 LABORATORY FOR DISCRETE SYSTEMS SIMULATION



Head of the Laboratory

**Prof. Borut Buchmeister**

E-mail: [borut.buchmeister@um.si](mailto:borut.buchmeister@um.si)

Tel.: +386 2 220 7631

Web: <http://lasdis.fs.um.si/>

The Laboratory for Discrete Systems Simulation pursues two goals: the establishment of a highly sophisticated laboratory that combines state-of-the-art simulation technologies with the most advanced simulation modelling procedures on powerful hardware and software, and the building of a research team involved in national and international activities in the field of Discrete events simulation and educational work. The activities of the laboratory include pedagogical work at all levels of study, and theoretical and user-oriented research work for industry, and publishing activities. The basic area of the laboratory research is discrete event simulation (the implementation of simulation studies for the optimisation of production processes, collaborative workplaces, service activities). The key activities are process planning, determination of workplace, buffer and transport capacities, layout of workplaces and transport routes, optimisation of the sequence of execution of tasks, presentation with virtual reality, and production analysis, all with the aim of understanding production processes better.

### MAJOR RESEARCH EQUIPMENT



**VR/AR Hardware Oculus Rift and Oculus Go Oculus VR, Menlo Park, USA and HTC Vive Pro HTC Corp., Taoyuan City, Taiwan**

The Virtual and Augmented reality equipment includes a series of sensors and algorithms that track the motion of the user's head and hands, enabling an immersive 3D experience in the work environment.

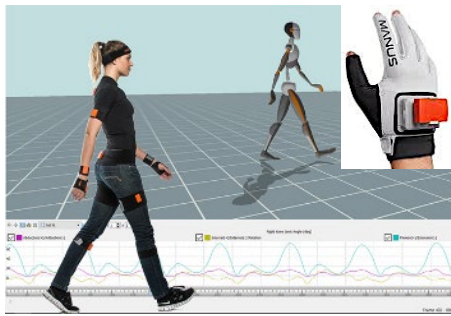

Sensorics, hardware and software for ergonomic analysis of the collaborative workplace: **Xsens MVN Human Motion Measurement** **Movella Inc. Henderson, USA**, sensor gloves **Manus gloves for Xsens-edition Manus, Geldrop, Netherlands**. The 17-sensor suit captures movements, generates data and transmits them to the software for processing for ergonomic studies, optimisation of work performance, etc. The sensor gloves are fully integrated into the Xsens' motion capture software, which allows us to capture real-time data on the movement of the fingers of the hand.

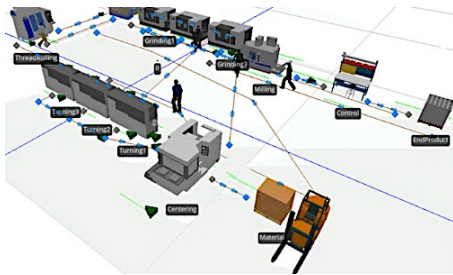

#### **SIMIO simulation software package** **Simio LLC, Sewickley, USA**

The SIMIO package is a modern, object-oriented platform for 3D discrete event simulation with support for simulation modelling, scheduling and digital twins. It contains a library of application-specific templates that contain predefined objects, process logic and data schemas without the need for programming.

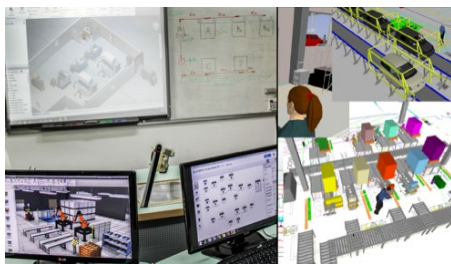

#### **Simulation software**

- Siemens PLM Software package,
- Autodesk Factory Design Suite package,
- SimFactory simulation package, SIMUL8 package,
- Plant Simulation package,
- Cost-Time Profiler software package,
- LEKIN-system for scheduling.

#### **SERVICE OFFER AND SUPPORT TO THE ECONOMY**

- Implementation of discrete simulations of processes in production and services (discrete event simulations), research of production dynamics according to different organisational variants, process planning, required capacities of workplaces, buffers and transport equipment, layout of workplaces and transport routes, sequence of execution of orders, inventory, costs, animated computer simulation of operation, etc.
- Training of experts in the field of simulation modelling.
- Publishing: support for the publication of scientific research achievements.

#### **COOPERATION WITH RESEARCH AND OTHER INSTITUTIONS**

- Faculty of Mechanical Engineering, University of Ljubljana, Ljubljana, Slovenia
- Technische Universität Wien, Vienna, Austria
- Beijing Jiaotong University, Beijing, China
- Faculty of Technical Sciences, University of Novi Sad, Novi Sad, Serbia
- Faculty of Mechanical Engineering and Naval Architecture, University of Zagreb, Zagreb, Croatia
- Faculty of Mechanical Engineering, University of Slavonski Brod, Slavonski Brod, Croatia
- DAAAM International Vienna, Vienna, Austria

#### **COOPERATION WITH COMPANIES**

Siemens, A. G., Munich, Germany, Seco Tools Si, d.o.o., Pesnica, Slovenia, SIMIO LLC, Sewickley, PA, USA, Crossref, Lynnfield, USA, INFORMS, Catonsville, USA.

#### **MOST IMPORTANT RESEARCH ACHIEVEMENT**

A new **simulation procedure for evaluating collaborative workplaces in sustainably designed manufacturing.**

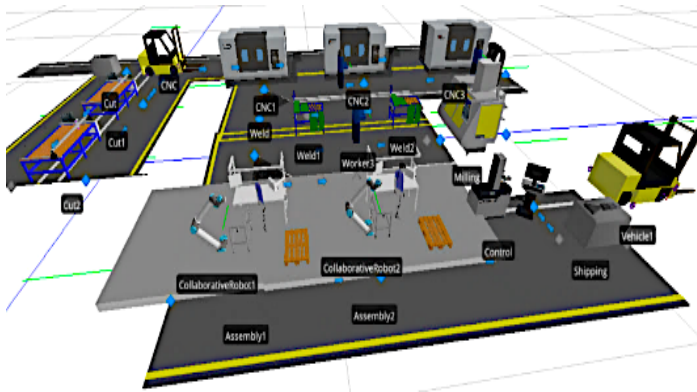

The approach is based on the newly proposed block diagram structure; with discrete simulation based on real input data from production, we evaluate the impact of the collaborative workplace from a financial, social and environmental point of view.

## PUBLICATIONS

1. ZHANG, Hankun, BUCHMEISTER, Borut, LI, Xueyan, OJSTERŠEK, Robert. An efficient metaheuristic algorithm for job shop scheduling in a dynamic environment. *Mathematics*. 2023, vol. 11, iss. 10, [article no.] 2336, str. 24. ISSN 2227-7390. <https://dk.um.si/IzpisGradiva.php?id=84308>, <https://dk.um.si/IzpisGradiva.php?id=84308>, DOI:10.3390/math11102336 [COBISS. SI-ID 152528131], [JCR, SNIP, WoS, Scopus] kategorija: 1A1 (Z, A', A1/2); uvrstitev: SCIE, Scopus, MBP (DOAJ, METADEX)
2. OJSTERŠEK, Robert, JAVERNIK, Aljaž, BUCHMEISTER, Borut. Optimizing smart manufacturing systems using a digital twin. *Advances in Production Engineering & Management*. Dec. 2023, vol. 18, no. 4, str. 475–485, ilustr. ISSN 1854-6250. <https://dk.um.si/IzpisGradiva.php?id=87708>, DOI: 10.14743/apem2023.4.486. [COBISS. SI-ID 182000131], [JCR, SNIP, WoS, Scopus] kategorija: 1A2 (Z, A', A1/2); uvrstitev: Scopus (d), SCIE, Scopus, MBP (INSPEC, METADEX)
3. OJSTERŠEK, Robert, ZHANG, Hankun, BUCHMEISTER, Borut. The importance of employees' knowledge in sustainable, green manufacturing: numerical modelling approach. *Sustainability*. Jan. 2022, vol. 14, iss. 3 (1344), str. 16. ISSN 2071-1050. DOI: 10.3390/su14031344. [COBISS. SI-ID 95026691], [JCR, SNIP]
4. OJSTERŠEK, Robert, BUCHMEISTER, Borut. Simulation modelling approach for collaborative workplaces' assessment in sustainable manufacturing. *Sustainability*. May 2020, vol. 12, iss. 10 (4103), str. 1–18. ISSN 2071-1050. DOI: 10.3390/su12104103. [COBISS. SI-ID 15812355], [JCR, SNIP]
5. BUCHMEISTER, Borut. *Modelling and simulation of production systems*. Vienna: DAAAM International Publishing, 2020. XIV, str. 140, ilustr. Danube Adria Association for Automation & Manufacturing. ISBN 978-3-902734-04-4.

## ARIS RESEARCH PROGRAMME

P2-0190 Advanced Concepts of Production Management and Dimensional Metrology

## NATIONAL AND INTERNATIONAL PROJECTS

- Change2Twind – Evaluation of the state of digitalisation in Slovenian companies and providing expert proposals for raising digitisation levels. DIH Slovenia, 14.07.2021 - 14.01.2022.
- Comparative study of robots from different manufacturers according to the technical requirements of the client, 2023.
- Shift organisation model – number of workers decision-making model, 2021.
- Twin manufacturing process simulation study, 2018.
- Editing service by Prof. Borut Buchmeister, Editor-in-Chief of the *International Journal of Simulation Modelling* (IJSIMM), publisher: DAAAM Int. Vienna, Austria. According to the latest ranking in JCR (for 2023), IJSIMM is a Q2 journal, in SCOPUS database (2023) it is also a Q2 journal (<http://www.ijssimm.com/>).

## MEMBERSHIPS

- INFORMS - Institute for Operations Research and the Management Sciences, Catonsville, USA
- DAAAM - International Vienna, Vienna, Austria

## 5.10 LABORATORY FOR PRODUCTION MEASUREMENT



Head of the Laboratory

**Prof. Bojan Ačko**

E-mail: [bojan.acko@um.si](mailto:bojan.acko@um.si)

Tel: +386 2 220 7581

Web: <https://ltm.fs.um.si/>

The laboratory is engaged in fundamental and industrial research, pedagogical activities and professional training in the fields of dimensional metrology, industrial measurements and quality management. It is focused on the development of measurement methods and procedures for precise measurement of dimensions in one, two and three coordinates and the automation of measurement processes. The key professional activity of the laboratory is the calibration of measuring instruments and material measures in the field of dimensional quantities. It also deals with measurement of products with complex geometry, and the implementation of quality management methods in industrial and service processes. The laboratory maintains accreditation for the calibration of physical length measures and measuring instruments according to the International standard ISO/IEC 17025:2017 at the Slovenian Accreditation, which is a signatory to the multilateral agreement EA MLA. It also maintains and develops the National Standard for length. The laboratory has its metrological capacities published in the database of National Metrology Institutes at the International Bureau of Weights and Measures (KCDB BIPM).

## MAJOR RESEARCH EQUIPMENT

**2D measuring device with sub-micrometre resolution**

**Newport, France.** A universal measuring device that is used in combination with laser interferometers to calibrate material measures (step gauges, precise line scales, 2D grids, etc.) at the highest accuracy level (up to 30 nm measurement uncertainty). It also serves for the research and development of new measurement methods and procedures, as well as for the experimental determination of measurement uncertainty. The device is the property of the Metrology Institute of the Republic of Slovenia.



**Frequency Stabilised He-Ne Laser Lasertex Poland.** The laser represents the frequency standard and is used as the primary length standard. We use it to calibrate the frequency of red-light lasers. The laser is also used for research on the stability of laser frequencies, and for experimental determination of the measurement uncertainty of measurement processes involving laser interferometers. Frequency stability is confirmed by international comparative measurements according to the BIPM rules.

**Laser Interferometer HP 5528A Agilent USA**

It is used mainly as material measure on 1D and 3D measuring devices for very precise measurement of lengths in one coordinate (resolution of 1 nm). It is also used as a measurement standard for high-precision calibration of 1D and 3D measuring devices and machine tools. With this instrument, in real laboratory conditions, we achieve a measurement uncertainty of up to 30 nm at very short distances, and up to 0.5 µm at a length of 1 m.

**Laser Interferometer LSP 30 Lasertex Poland**

It is used mainly as a material measure on 1D and 3D measuring devices for very precise measurement of lengths in one coordinate (resolution of 1 nm). It is also used as a measurement standard for very precise calibration of 1D and 3D measuring devices and machine tools. With this instrument, in real laboratory conditions, we achieve a measurement uncertainty of up to 30 nm at very short distances, and up to 0.5 µm at a length of 1 m.





### Three-coordinate measuring device UMC 850 Carl Zeiss Germany

The device can measure complex industrial products up to a volume of 1200 mm x 850 mm x 600 mm, and it is also useful for calibrating material measures such as gauge rings and plugs, and threaded gauges. It measures according to the point-to-point or scanning principle, and the accuracy level is from 2  $\mu\text{m}$  to 5  $\mu\text{m}$ . The device is also used for research on the principles of measuring complex geometries, and for research on the integration of laser interferometers into a three-coordinate measurement technique.



**Measuring stage 13M LTM UM FS LTM in-house production.** We use the measuring stage of our own production for the calibration of industrial line scales and tape measures. The device has a measuring range of 12 m, but by folding the gauge, we can also calibrate tape measures up to 200 m. The device is equipped with a magnetic measuring encoder with a resolution of 1  $\mu\text{m}$ , and a laser interferometer can also be integrated into the device for very precise measurements.



### Short gauge block comparator C. MAHR Germany

The device is intended exclusively for the calibration of gauge blocks up to 100 mm according to the principle of mechanical comparison with a reference standard. The resolution of the device is 10 nm, and the minimum measurement uncertainty when calibrating short gauge blocks is 35 nm. The device is also used for research on the effects on measurement uncertainty in the measurement of short lengths.

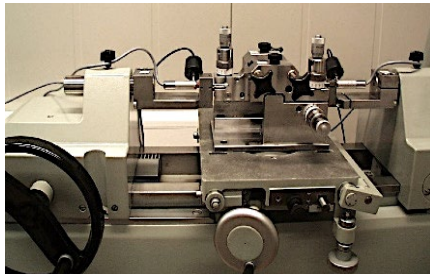

### Calibration device for long gauge blocks UM FS LTM, in-house production.

The purpose-built device of our own production is intended exclusively for the calibration of gauge blocks from 100 mm to 1000 mm according to the principle of mechanical comparison with a reference standard. The resolution of the device is 10 nm. The basis of the device is a universal measuring machine ZEISS 3000 mm. The device is also used to investigate thermal expansion of materials and the effects on measurement uncertainty in comparative measurement.

## SERVICE OFFER AND SUPPORT TO THE ECONOMY

- Calibration of material measures (gauge blocks, rings, plugs, line scales, step gauges, threaded gauges...) and measuring instruments (1D and 2D measuring machines, comparators for calibrating dial gauges and gauge blocks, precise contact sensors, dial gauges, micrometres, etc.). We have obtained SA accreditation for all calibration services, and the capacities for most calibrations are also published in the international metrology database at BIPM.
- Measurement of industrial products of complex shapes (3D).
- Evaluation of measurement uncertainty for calibration procedures for length material measures and instruments.
- Development of calibration procedures for length material measures and instruments.
- Establishment and assessment of the competence of calibration laboratories.
- Introduction of various methods of quality assurance and control into industrial processes.
- Dissemination of expertise by organising and conducting consultations, seminars, workshops, or other forms of public professional meetings at national or international levels.

## COOPERATION WITH RESEARCH AND OTHER INSTITUTIONS

- PTB - Physikalisch-Technische Bundesanstalt, Braunschweig, Germany

- NPL - National Physical Laboratory, Teddington, United Kingdom
- LNE - National Laboratory of Metrology and Testing, Paris, France
- VTT MIKES - Metrology Institute, Espoo, Finland
- CMI - Czech Metrology Institute, Brno-Prague, Czech Republic
- GUM - Central Office of Measures, Warsaw, Poland
- BEV - Federal Office of Metrology and Surveying, Vienna, Austria
- Department of Metrology, Podgorica, Montenegro
- Graz Technical University, Graz, Austria
- University of Zagreb, Zagreb, Croatia
- University of Novi Sad, Novi Sad, Serbia
- University of Zenica, Zenica, Bosnia and Herzegovina
- University of Ljubljana (FE, FS), Ljubljana, Slovenia
- Office of Metrology of the Republic of Slovenia, Ljubljana, Slovenia
- Department of Civil Engineering - ZAG Ljubljana, Ljubljana, Slovenia
- Institute of Metallic Materials and Technologies - IMT, Ljubljana, Slovenia

#### COOPERATION WITH COMPANIES

Hexagon Metrology S.P.A., LOTRIČ Meroslovje, d.o.o., SIJ Ravne Systems, d.o.o., MPT sistemi, d.o.o., 5Labs, d.o.o., GAZELA, d.o.o., SIQ Ljubljana, MERITVE SI, d.o.o., MEREL, d.o.o., PRIMAT, d.d., IRMA, d.o.o., NOVEM Car Interior Design, d.o.o., MIKRO+POLO, d.o.o., DOMEL, d.o.o., IMPOL LLT, d.o.o., SAVATECH, d.o.o., TEHNO POND, d.o.o., TENOVIS, d.o.o., Labena, d.o.o., KYMA Tehnologija, d.o.o., OPTOTEK, d.o.o., BELIMED, d.o.o., TEHNO PETROL, d.o.o., AUTOINSTRUMENT, IKEMA, d.o.o., LEHENTECH, d.o.o., RaMaX Engineering, d.o.o., ADR test sistemi, d.o.o., INTERBLOCK, d.d., INŠTITUT BAM ...

#### MOST IMPORTANT RESEARCH ACHIEVEMENT

##### **Measuring system and calibration procedures for fully automated calibration of step and line gauges.**

In the laboratory we designed a universal measuring device for measuring in two dimensions with sub-micrometre resolution, which was manufactured based on our design in the company Newport, France. The device was later upgraded with an optical and mechanical sensor and a laser interferometer, and calibration procedures were made that are fully automatic without the presence of the operator. The accuracy of the elaborated procedures is comparable to the accuracy of the world's most reputable national metrological institutes. The measurement uncertainty ranges from 90 nm to 500 nm (over a length of 1 m).

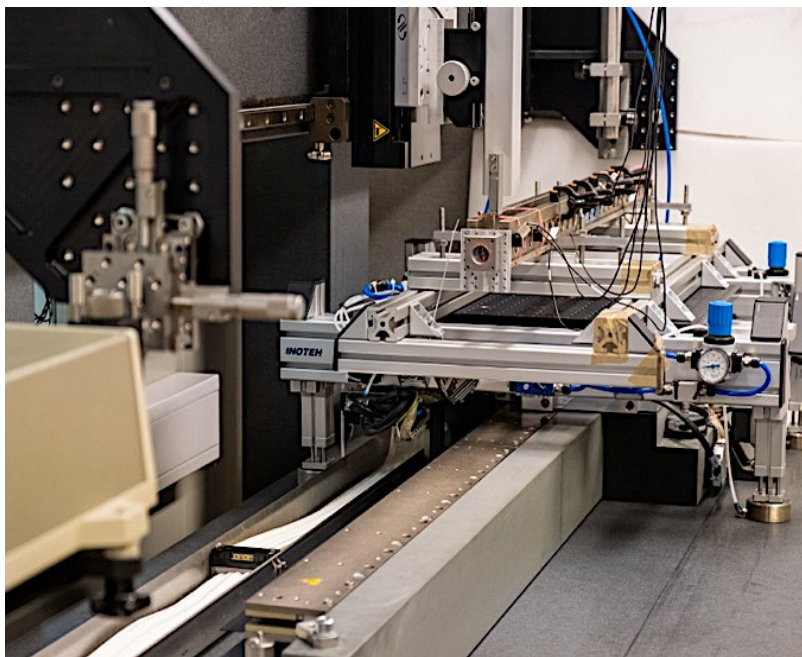

## PUBLICATIONS

1. ČREPINŠEK-LIPUŠ, Lucija, AČKO, Bojan, TOMPA, Jasna. *Experimental determination of influences on a gauge block's stack length. Advances in Production Engineering & Management. Sept. 2022, vol. 17, no. 3, str. 339–349, illustr. ISSN 1854-6250. <http://www.dlib.si/details/URN:NBN:SI:doc-R11UA5JX>, DOI: 10.14743/apem2022.3.440. [COBISS. SI-ID 132896771].*
2. ŠAFARIČ, Jakob, KLOBUČAR, Rok, AČKO, Bojan. *Measurement setup and procedure for precise step gauge calibration. IEEE transactions on instrumentation and measurement. [Print ed.]. 2021, vol. 70, str. 1009610-[1]-1009610-[10], illustr. ISSN 0018-9456. DOI: 10.1109/TIM.2021.3115579. [COBISS. SI-ID 85310979].*
3. ČREPINŠEK-LIPUŠ, Lucija, BUDZYN, Grzegorz, AČKO, Bojan. *Analysis of laser interferometer measurement uncertainty by simulating error sources. International Journal of Simulation Modelling. June 2021, vol. 20, no. 2, str. 339–350. ISSN 1726-4529. DOI: 10.2507/IJSIMM20-2-563. [COBISS. SI-ID 67778819].*
4. AČKO, Bojan, WEBER, Hubert, HUTZSCHENREUTER, Daniel, SMITH, I. *Communication and validation of metrological smart data in IoT-networks. Advances in Production Engineering & Management. Mar. 2020, vol. 15, no. 1, str. 107–117, illustr. ISSN 1854-6250. <http://www.dlib.si/details/URN:NBN:SI:doc-LARKH5XK>, DOI: 10.14743/apem2020.1.353. [COBISS. SI-ID 23128086].*
5. ŠTRBAC, Branko, AČKO, Bojan, HAVRLIŠAN, Sara, MATIN, Ivan, SAVKOVIĆ, Borislav, HADŽISTEVIĆ, Miodrag. *Investigation of the effect of temperature and other significant factors on systematic error and measurement uncertainty in CMM measurements by applying design of experiments. Measurement: Journal of the International Measurement Confederation. 2020, vol. 158 (107692), str. 1–10. ISSN 0263-2241. DOI: 10.1016/j.measurement.2020.107692. [COBISS. SI-ID 13760003].*

## ARIS RESEARCH PROGRAMME

P2-0190 Advanced Concepts of Production Management and Dimensional Metrology

### NATIONAL AND INTERNATIONAL PROJECTS

- Establishment of the central implementation of national inter-laboratory comparisons in the national metrological system. ARIS project, 01.09.2021 - 28.02.2023.
- DI-Vision - Traceable machine vision systems for digital industrial application. EMP 23IND08, 1.9.2024 - 31.8.2027.
- Communication and validation of smart data in IoT-networks. H2020-EMPIR 17IND02, 1.6.2018 - 30.9.2021.
- Traceable in-process dimensional measurement. FP7-EMRP IND62, 1.6.2013 - 31.5.2016.
- Traceability of computationally intensive metrology. FP7-EMRP NEW06, 8.3.2012 - 31.6.2015.
- Calibration of gauge blocks by mechanical comparison. EURAMET. L-S2.2.n01, 8.3.2023 - 31.12.2024.
- Key comparison on calibration of 1-D CMM artefacts: Step Gauges. EURAMET. L-K5.n01, 1.7.2022 - 31.12.2023.
- Supplementary comparison on calibration of a transducer 60 mm. EURAMET. L-S31, 1.11.2020 - 31.12.2023.
- Measurement of Steel Tapes of 10 m and 50 m. EURAMET. L-S27, 1.1.2018 - 31.12.2023.

### MEMBERSHIPS

- EURAMET - contact person for the Republic of Slovenia in the Technical Committee for Length of the European Association of National Metrology Institutes
- SIST Member - Assembly of the Slovenian Institute for Standardization
- Expert Committee for Metrology at Slovenian Accreditation

## 6. TEXTILE MATERIALS AND DESIGN

In the field of Textile Materials and Design, there are 6 laboratories and 3 centres:

LABORATORY:	HEAD:
6.1 Laboratory for Dyeing, Colorimetry and Finishing Ecology	Alenka Ojstršek
6.2 Laboratory for Chemistry and Environmental Protection	Julija Volmajer Valh
6.3 Laboratory for Characterisation and Processing of Polymers	Lidija Fras Zemljič
6.4 Laboratory for Clothing Engineering, Physiology and Garment Construction	Jelka Geršak
6.5 Laboratory for Fabric Planning and Construction	Polona Dobnik Dubrovski
6.6 Laboratory for Textile Printing and Textile Care	Manja Kurečič
6.7 Centre for Dyeing and Color	Alenka Ojstršek
6.8 Centre for Textile Care	Manja Kurečič
6.9 Research and Innovation Centre for Design and Clothing Science	Jelka Geršak



*Head of the Chair of Textile Materials and Design*

**Prof. Tatjana Kreže**

E-mail: [tatjana.kreze@um.si](mailto:tatjana.kreze@um.si)

Tel: +386 2 220 7890

Web: <https://www.fs.um.si/oblikovanje-in-tekstilni-materiali/>

The activities of the Chair of Textile Materials and Design of CTMD include education and basic and applied research in the field of engineering polymer materials and composites, as well as research in the field of textile and clothing design and the development of smart materials and clothing. In addition, the chair cooperates actively with economic organisations both in the field of research and development, as well as by offering testing services for textiles and other polymeric materials, consulting, etc. CTMD's research activities include research in various fields of textile and design, with an emphasis on research activities in newly developing sciences and technologies, e.g., nanomaterials and nanotechnologies, bio active materials and functional surfaces, etc. More than 50 researchers are active within CTMD, organised into six laboratories and three centres, who are involved actively in numerous research programmes and projects, intended for the research of advanced polymer materials, their processing and design. The chair makes an important contribution to the development and progress of these fields, especially through the active participation of excellent researchers in international research programmes and projects, such as Horizon 2020, EraNet, Erasmus+, etc.

### 6.1 LABORATORY FOR DYEING, COLORIMETRY AND FINISHING ECOLOGY



*Head of the Laboratory*

**Assist. Prof. Alenka Ojstršek**

E-mail: [alenka.ojstrsek@um.si](mailto:alenka.ojstrsek@um.si)

Tel.: +386 2 220 7935

Web: <https://www.fs.um.si/laboratorij-za-barvanje-barvno-metrika-in-ekologijo-plemenitenja/>

The laboratory conducts basic and applied research and educational programmes and offers services in the field of colouring and evaluation of optical properties of materials in the UV/Vis/NIR wavelength range of 200–2500 nm. The research also includes the removal of pollutants from wastewater and air with various adsorbents or filter membranes from renewable sources. An important part of the work is the development of innovative processes for the sustainable preparation and functionalisation of textile materials, polymer films, membranes and aerogels with chromium dyes, pigments and nano- or microparticles for special properties. Cooperation with microbiology groups of related research institutions includes research on the production of bacterial cellulose and its applications. The new area covers the development of high-tech materials, including functional surfaces, printed electronics, sensors, secure documents, OLED displays, batteries and other applications, with



a focus on automation using the Challenger 175. Additional research is focused on the modification and functionalisation of biopolymer materials, such as proteins and nanocellulose, using green chemistry.

#### MAJOR RESEARCH EQUIPMENT

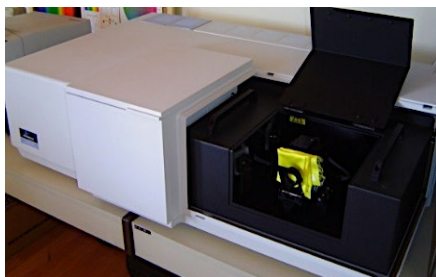

##### UV-VIS-NIR Spectrophotometer Lambda 900 Perkin Elmer

It is used to measure the reflection, transmission or absorbance of solid samples. Technical characteristics: two-beam measuring principle, spectral range 175-3300 nm, light source of tungsten-halogen and deuterium lamps, sample size 200 x 220 x 300 mm (ŠVG), operating temperature 10-35°C, relative humidity 10-70%.



##### UV-VIS SF 600 Plus spectrophotometer Datacolor

It is used to measure the reflection of solid samples, to determine colour values and colour differences according to CIEL\*a\*b\*, CMC(l:c), Hunter L\*a\*b\*, ANLAB 40, and to determine whiteness according to CIE, Ganz-Griesser, Harrison, Hunter, Berger. Technical characteristics: spectral range 400-700 nm, two-beam measuring principle, measurement geometry d/10°, possibility of measuring with three measuring apertures.



##### Infinite M200 computer-aided microplate reader Tecan

- Measurement of absorbance: 230–1000 nm.
- Fluorescence measurement: 280–850 nm (selection), plus spectral chemistry (excitation and emission).
- Reading from above or below.



##### Turby Dyeing Machine Mathis

Dyeing apparatus for dyeing (including pre-treatment and post-processing) of various textile materials after the exhaustion process. It enables high temperature colouring (up to 130 °C) with precise temperature and time regulation, and the sharing of ultrasound probes, simultaneous measurement of absorbance and pH. It has 10 colouring spots.

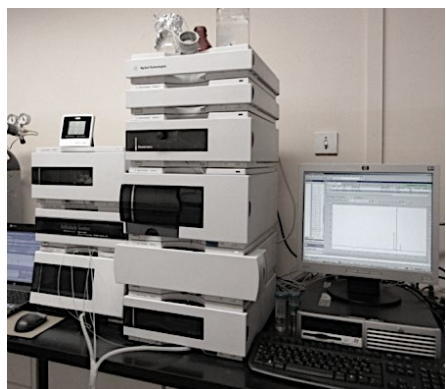

##### HPLC 1200 Series Agilent Technologies

This is a high-resolution liquid chromatography system with Agilent ChemStation software. It is used for the qualitative and quantitative identification of water-soluble or organotopic molecules (e.g., polysaccharides, proteins, amino acids, etc.) using the exclusion (SEC), affinity (AC) or ion-exchange (IEC) methods.



**PERME OX2/230 - OTR Labtechnik instrument**

This is a device for measuring oxygen permeability with WinPerme OX2/230 W3/330 software. It is suitable for measuring the oxygen permeability of various materials (i.e., plastic films, solar and laminated materials, aluminium foils and bottles, bags, jars made of plastic, rubber, paper, glass and metal).

Standards: ASTM D3985, ASTM F2622, ASTM F1307, ASTM F1927, ISO 15105-2, JIS K7126-B, GB/T 19789, YBB 00082003

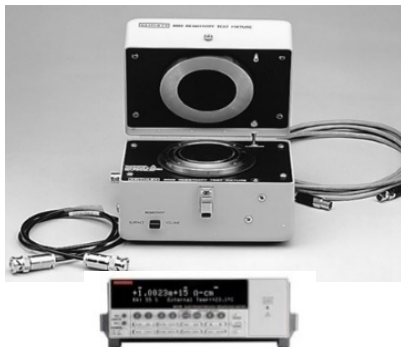

**Electrical Resistance Meter 6517B Keithley**

Electrical resistance meter with high voltage source ( $\pm 1000V$ ) for measuring surface charge (2nC-2uC), high (surface and volumetric) resistors (2M $\Omega$ -200T $\Omega$ ) and small currents (20pA-20mA).



**Chamber for one-sided freezing of liquid samples (porosity gradient) LBBE FS**

Computer-controlled cooling of aluminium plates (bottom/top). Adjustment of the distance between the panels.

Cooling temperature range: 0-150 °C, accuracy  $\pm 0.1-3$  °C.



**Autolab PGSTAT101 Potentiostat/Galvanostat Methrom**

Autolab/PGSTAT101 in combination with the powerful NOVA software is used for most standard electrochemical techniques.



**Automated device for single-sided coating and printing of flat substrates Challenger 175 Nobert Schläfli**

The device enables a controlled (in terms of surface and thickness of application) and repeatable (sequential) method of applying coatings (high  $\mu m$ -accuracy and repeatability) on a flat surface with a selected module (a rotary template of various perforations and designs or dead slot/slot-die of different thicknesses and width of channels) and the possibility of drying with advanced (fast, efficient and low-energy) NIR irradiation in a continuous process.



### SERVICE OFFER AND SUPPORT TO THE ECONOMY

- The new, fully automated (computer-controlled) Challenger 175 (nsm Nobert Schläfli AG, Switzerland) enables direct and in-depth research and development cooperation (prototyping, TRL 1-4) with industrial partners in various sectors (textile, paper, packaging, medical, security/information, electronics/sensor/coatings manufacturers), and, above all, offers the opportunity to participate in numerous research and development projects related to umbrella and specific areas within the various EU Programmes set by 2030 (digitalisation/advanced materials, process intensification, health/safety, durable/active/intelligent packaging).
- Analyses of the L\*a\*b\* colour values of materials according to the CIE Standard, measurement of whiteness according to various formulas and determination of the UV protection factor.
- Measurement of the reflection/transmission/absorbance of materials in the UV/VIS/NIR-range.
- Conventional analysis and testing of textile materials (fibres, yarns and flat textiles) according to the Standards.
- Analysis and planning of classical and modern dyeing and refining processes.

### COOPERATION WITH RESEARCH AND OTHER INSTITUTIONS

- Jožef Stefan Institute, Ljubljana, Slovenia
- Institute of Chemistry, Ljubljana, Slovenia
- University of Ljubljana, Ljubljana, Slovenia
- Institute for Pulp and Paper, Ljubljana, Slovenia
- Faculty of Polymer Technology, Slovenj Gradec, Slovenia
- Karl Franzens University of Graz, Graz, Austria
- University of Technology Graz, Graz, Austria
- Coventry University, Coventry, United Kingdom
- University of Natural Sciences and Humanities in Siedlce, Poland
- "Gheorghe Asachi" Technical University of Iasi, Iasi, Romania
- University of Medicine and Pharmacy, Iasi, Romania
- Erciyes University, Kayseri, Turkey
- University of Zagreb, Zagreb, Croatia
- Institute for Medical Research and Occupational Medicine, Zagreb, Croatia
- University of Ghent, Ghent, Belgium
- West Pomeranian University of Technology in Szczecin, Poland
- Technion - Israel Institute of Technology, Haifa, Israel
- VTT Technical Research Centre of Finland, Espoo, Finland
- Aalto University, Aalto, Finland
- Stockholm University, Stockholm, Sweden
- EMPA, St. Gallen, Switzerland

### COOPERATION WITH COMPANIES

Čateks, d.d., Croatia; Krka, d.d., Slovenia; Litia Spinnery, d.o.o., Slovenia; Silkem, d.o.o., Slovenia; AquafilSLO, d.o.o., Slovenia; Cinkarna Celje, d.d., Slovenia; Innovation Service Network, d.o.o., Slovenia; Weiler Abrasives, d.o.o., Slovenia; Printed Electronics Ltd, United Kingdom; A-Gas Electronic Materials, UK; Textile Testing Institute s.p., Czech Republik; Educell, d.o.o., Slovenia; InnoRenew CoE, Slovenia; MyBiotech, Germany; CIBER, Spain; Bionanonet, Austria; Gorenje, d.o.o., Slovenia; Tekstina, d.o.o., Slovenia; IRNAS, d.o.o., Slovenia; BiaSeparations, d.o.o., Slovenia.

### MOST IMPORTANT RESEARCH ACHIEVEMENT

**Development of a sustainable process to produce bacterial nanocellulose (BnC)** using an alternative medium to produce bacterial nanocellulose (patent) and in situ/ex situ modification processes of BnCja.

**Development of flame retardant and UV-blocking membranes** from cellulose nanofibrils and lignosulfonate-rich biological waste for a wide range of technical applications where recycling and cost-effectiveness are



essential. **Development of biopolymer membranes** based on chitosan and (modified) nanocellulose or graphene oxide for direct use in ethanol fuel cells.

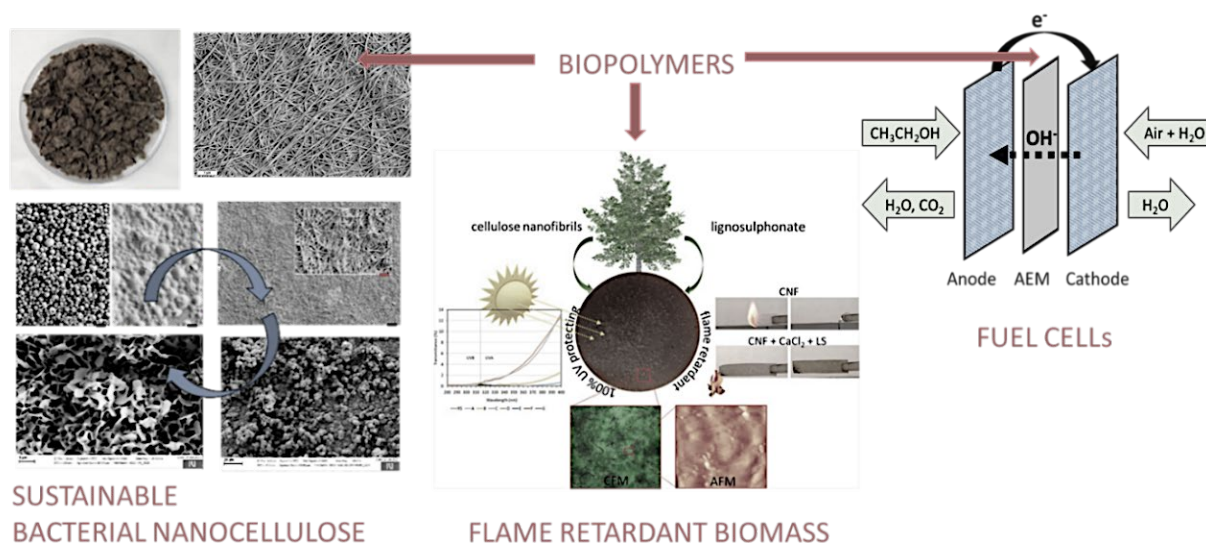

## PUBLICATIONS

1. GORGIEVA, Selestina, JANČIČ, Urška, CEPEC, Eva, TRČEK, Janja. Production efficiency and properties of bacterial cellulose membranes in a novel grape pomace hydrolysate by *Komagataeibacter melomenus* AV436T436 and *Komagataeibacter xylinus* LMG 1518. *International Journal of Biological Macromolecules*. [Print ed.]. 2023, vol. 244, [article no.] 125368, str. 16, illustr. ISSN 0141-8130. DOI: 10.1016/j.ijbiomac.2023.125368
2. OJSTRŠEK, Alenka, FAKIN, Darinka, HRIBERNIK, Silvo, FAKIN, Tomaž, BRAČIČ, Matej, KUREČIČ, Manja. Electrospun nanofibrous composites from cellulose acetate / ultra-high silica zeolites and their potential for VOC adsorption from air. *Carbohydrate Polymers*, ISSN 0144-8617. [Print ed.], 15 May 2020, vol. 236 (116071), str. 1–11, illustr., doi: 10.1016/j.carbpol.2020.116071
3. OJSTRŠEK, Alenka, CHEMELLI, Angela, OSMIČ, Azra, GORGIEVA, Selestina. Dopamine-assisted modification of polypropylene film to attain hydrophilic mineral-rich surfaces. *Polymers*. Feb. 2023, vol. 15, iss. 4, [article no.] 902, 14 str. ISSN 2073-4360. DOI: 10.3390/polym15040902
4. RUBERTO, Ylenia, VIVOD, Vera, JUHANT GRKMAN, Janja, LAVRIČ, Gregor, GRAIFF, Claudia, KOKOL, Vanja. Slot-die coating of cellulose nanocrystals and chitosan for improved barrier properties of paper. *Cellulose*. April 2024, vol. 31, iss. 6, str. 3589–3606. ISSN 0969-0239. DOI: 10.1007/s10570-024-05847-3.
5. LAKSHMANAN, Subramanian, JUREČIČ, Vida, BOBNAR, Vid, KOKOL, Vanja. Dielectric and thermal conductive properties of differently structured Ti3C2Tx/Ti3C2Tx MXene-integrated nanofibrillated cellulose films. *Cellulose*. Published 02 August 2024, 20 str. ISSN 1572-882X, DOI: 10.1007/s10570-024-06105-2.

## PATENTS AND PATENT APPLICATIONS

- GORGIEVA, Selestina, TRČEK, Janja, OSMIČ, Azra, CEPEC, Eva. A food waste extract for cultivation of microorganisms and production of bacterial cellulose and a process for obtaining said extract: EP23158370.9, 2023-02-23. Munich: European Patent Office, 2023. [7] str. [COBISS. SI-ID 106057475]
- GORGIEVA, Selestina, TRČEK, Janja, OSMIČ, Azra, CEPEC, Eva. Extract from food waste for the cultivation of microorganisms and the production of bacterial cellulose and the process of obtaining said extract: Patent SI 26318 A, 31.8.2023. Ljubljana: Intellectual Property Office of the Republic of Slovenia, Ministry of Economy, Tourism and Sport, 2023. [21] p. [COBISS. SI-ID 100023299] Patent Family: Patent No: SI 26318 A, 31/08/2023; Application No: P-202200026, 28.2.2022; Number: 31200-26/2022-2, dated 02/03/2022.
- GORGIEVA, Selestina, OJSTRŠEK, Alenka, BOŽIČ, Mojca, JANČIČ, Urška, HRIBERNIK, Silvo. Process for the preparation of non-combustible aerogels based on nanofibrillated cellulose: patent SI 25918 A, 2021-05-31. Ljubljana: Intellectual Property Office of the Republic of Slovenia, 2021. [16] p. [COBISS. SI-ID 21196035] patent family: P-201900222, 2019-11-13.

- GORGIEVA, Selestina, OJSTRŠEK, Alenka. Bacterial Cellulose Modification Process by Microstructured Gelatin Coating: Patent SI 25790 A, 2020-08-31. Ljubljana: Intellectual Property Office of the Republic of Slovenia, 2020. p. [1], p. 8, p. 1/3-3/3, illus. [COBISS. SI-ID 27283715], patent family: P-201900025, 2019-02-07.

#### ARIS RESEARCH PROGRAMMES

P2-0118 Textile Chemistry and Advanced Textile Materials

P2-0424 Design of New Properties of (nano)materials and Applications

#### NATIONAL AND INTERNATIONAL PROJECTS

- 2D-paper Thermally conducting paper substrates. Flag-Era III JTC 2023, 2024-2027.
- Nanofibrillar cellulose membranes in microbial fuel cells: the development of materials for sustainable applications with high added value. J2-50086, 2023-2026.
- Production of high-capacitance electrospinning fibre for a flexible supercapacitor. J2-50087, 2023-2026.
- Bioactive, in situ modified, fibrous membranes based on bacterial cellulose: processing, characterisation and evaluation of usefulness in biomedicine. J2-2487, 2020-2024.
- Development of high-performance piezoelectric coatings for automatic power supply of non-textile textiles useful in e-mobility. J2-3053, 2021-2024.
- Bionanotechnology as a tool for stabilisation and application of bioactive substances from natural sources. J2-3037, 2021-2024.
- Development of new graphene-based membranes and electrodes for use in ethanol fuel cells. N2-0087, 2020-2021.
- Structural and surface properties of fibre membranes for purification and chromatographic separation of biomacromolecules. J2-1719, 2019-2022.
- Development of nanotextured yarns, fabrics and foils for heat and fire protective textile products. L2-9249, 2018-2021.
- Development of functional-gradient, multilayer, biopolymer membranes for watery periodontal regeneration. Z7-7169, 2012-2018.
- Zeolite-modified fibrous polymers; fabrication, characterisation and application. L2-6776, 2014-2017.
- Development of natural nanoefficient adsorbents and filter membranes for cleaning washing baths and their subsequent (in-situ) reuse during the household textile washing process. L2-7576, 2016-2019.
- Biotechnological processes of treatment of lignocellulosic materials. L4-3641, 2010-2013.
- Compact fibrous polymers in biological wastewater treatment systems: definition, interactions and applicability. Z2-2064, 2009-
- Inorganic Post-hybridisation of 3D Printed Biopolymers and Their Biological Significance. BI-AT/20-21-003, 2020-2022.
- Modified bacterial cellulose as an artificial biomimetic membrane for the biological brain barrier. BI-HR/20-21-001, 2020-
- Formulation and optimisation of nanoparticles with antibiotics incorporated into a bacterial cellulose-based membrane for the treatment of resistant, pathogenic, intercellular bacteria during postoperative infection therapy. BI-ME/21-22-022, 2021-2023.
- Preparation of nanocellulose-based materials with embedded silver nanoparticles for controlled antimicrobial activity. SLO-RS/043, 2018-2019.
- Development of biomimetic organic-inorganic coatings for improved osseointegration of Mg based implants. SLO-DE/002, 2018-2019.
- Development of hydroxyapatite-nanocellulose based 3D structured hybrid materials for gas sensing applications. SLO-IND, 2015-2017.
- NABIHEAL - Antimicrobial nanostructured biomaterials for complex wound healing. HORIZON-CL4-2022-RESILIENCE-01-13, 2023-2027.



- MATUROLIFE – Metallisation of textiles to make urban living for older people more independent and fashionable. H2020-NMBP, 2018–2021.
- NanoTextSurf Nanotextured surfaces for membranes, protective textiles, friction pads and abrasive materials. H2020-PILOTS-760601, 2017–2020.
- Waste biorefinery technologies for accelerating sustainable energy processes WIRE. COST akcija CA20127, 2021–2025.
- NanoElMem – Designing new renewable nano-structured electrode and membrane materials for direct alkaline fuel cells. M-era.Net, 2017–2020.
- EUPHRATES EU promotion of health through research, applied technology, education and science in India. Erasmus-Mundus (EMA2)-2013–2540/001, 2013–2017.
- NanoBarrier Extended shelf-life biopolymers for sustainable and multifunctional food packaging solutions. FP7-NMP-2011-LARGE-5-280759, 2012–2016.
- NanoSelect Functional membranes/filters with anti/low-fouling surfaces for water purification through selective adsorption on biobased nanocrystals and fibrils. FP7-NMP-2011-SMALL-5-280519, 2012–2016.
- POLYSURF Development of smart polymer surfaces. Marie-Curie-ToK/DeV-FP6-MTKD-CT-2005-029540, 2006–2009.
- ENZUP Enzymatic up-grading of wool fibres. FP6-2004-SME-COOP-032877, 2006–2008.
- nPOSSCOG Nano-polysaccharide containing scaffolds with controlled porosity and degradability. EraNet-MNT, 2012–2015.
- TABANA Targeting antimicrobial activity via micro/nano-structured surfaces for civil applications. EraNet-MNT, 2011–2013.
- ANTIMICROB PEPTIDES Targeting of a material's antimicrobial activity by newly engineered peptides. EraNet-MateraPlus, 2010–2013.
- NANOWELL Nanostructured functional and active textiles for well-being. EraNet-Manunet, 2009–2010.

#### MEMBERSHIPS

- EPNOE - European Network of Excellence for Polysaccharide
- ESB - European Network for biomaterials
- AUTEX - Association of Universities for Textile
- EURATEX - European Technology Platform for the Future of Textiles and Clothing
- COST action CA20101, Plastics monitoring detection Remediation recovery (PRIORITY, 2021-2025)
- COST action CA20127, Waste biorefinery technologies for accelerating sustainable energy processes
- NATO AC/323 SCI-212/ET - Membership in the Research Network

## 6.2 LABORATORY FOR CHEMISTRY AND ENVIRONMENTAL PROTECTION



*Head of the Laboratory*

**Assoc. Prof. Julija Volmajer Valh**

E-mail: [julija.volmajer@um.si](mailto:julija.volmajer@um.si)

Tel.: +386 2 220 7897

Web: <https://www.fs.um.si/laboratorij-za-kemijo-in-okoljevarstvo/>

The basic activities of the laboratory are educational and research work in the fields of chemistry, organic chemistry, analytical methods, recycling and the study of the negative impact of textile and plastic waste on the environment. The laboratory performs spectroscopic characterisation of ATR FTIR, RAMAN UV-/VIS analyses and spectroscopic characterisations at the micro-level with FTIR microscopy. The general characterisation of waters, which includes the determination of various parameters such as hardness, pH value, electrical conductivity, turbidity, colouring, COD, BPK and TOC values as well as the determination of heavy volatile lipophilic substances

(TLS) and toxicity test using the Vibrio Fisheri method, is also part of the laboratory's range of services. In the field of research, the group focuses on the development of new technologies for wastewater treatment using advanced oxidation processes, and on the chemical and thermomechanical recycling of textile and plastic materials, with the aim of obtaining new secondary raw materials.

#### MAJOR RESEARCH EQUIPMENT

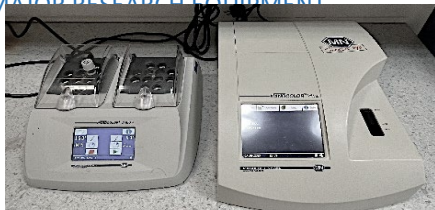

##### **NANOCOLOR Macherey-Nagel**

The device consists of a thermoblock and a measuring unit. With the help of prefabricated reagent kits, it enables standard tests for water analysis to be carried out based on photometric analysis. The manufacturer offers more than 500 kits. The device enables the measurement of UV/VIS values at selected wavelengths.



##### **Luminometer Dr. Lange**

*Vibrio fischeri* Bacteria Toxicity Determinant. Exposure to toxic substances in water leads to an inhibition of the bioluminescence of *Vibrio fischeri* bacteria, which is measured with a luminometer before exposure to the test substance and after a certain incubation time. The decrease in light intensity is inversely proportional to the toxicity of the test substance. The aim of the test is to determine the concentration of the test substance that leads to a 50 % inhibition of luminescence compared to the control within a certain incubation time. The test organisms are commercially available.

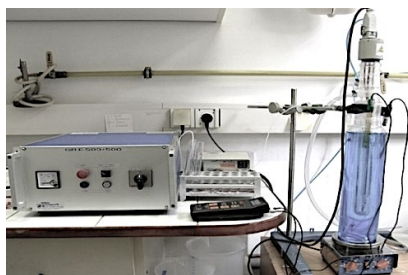

##### **H2O2/UV Naprava Solvay Interox**

The device enables the decomposition of organic substances in wastewater and works according to the principle of advanced oxidation processes (AOP). The resulting hydroxyl radicals (which are formed from H<sub>2</sub>O<sub>2</sub> with the help of a UV activator) oxidise almost indiscriminately all organic pollutants present in wastewater. The volume of the reactor is 1.8 L. The power of the UV lamp can be set to 500 or 1000 W.



**Oxitop Control 12** The device consists of a chamber, bottles with a measuring head and an OC 100 controller. The OxiTop® control system uses software-controlled functions and an infrared interface for communication between the measuring head and the OC 100 controller. This connection allows you to work in a group simultaneously, manage, store and track 100 measuring heads and monitor the results on a graphical display. The data can be transferred to a personal computer for evaluation and documentation via the AK-540/B cable and the Achat OC communication program. The measuring head works according to the manometric method with a built-in pressure sensor. The chamber has an adjustable temperature from 5 °C to +65 °C.



##### **Climate chamber KK 105 CH Kambič**

The climate air conditioning chamber is designed for carrying out experiments at a constant temperature and relative humidity. It is primarily used for studies on artificial ageing and biodegradability.



#### Reactor Büchi

A 10-litre stainless steel reactor in which reactions can be carried out at elevated temperatures (up to 300 °C) and pressures (up to 50 bar).



#### FTIR-RAMAN spectrophotometer with AUTOIMAGE microscope Perkin Elmer.

Technical data: IR medium, beam splitter: KBr and Mylar, detectors: DTGS (medium IR and FIR), working range: 7000-50 cm<sup>-1</sup>, automatic imaging option, tungsten-halogen illuminator, automatic microscope. The Perkin Elmer

Spectrum GX is a single-beam infrared spectrometer based on the Michelson interferometer and the Fourier transform. It has a two-stage optical module that is sealed and dried. The system is equipped with a single source of mid-infrared radiation. With the MIR and FIR beam splitters and the DTGS detector kits, you can cover the range from 7000 to 50 cm<sup>-1</sup> with a maximum resolution of 0.3 cm<sup>-1</sup>. The Spectrum GX is a modular system and can accommodate up to four equivalent output beams.

#### SERVICE OFFER AND SUPPORT TO THE ECONOMY

- Wastewater treatment with advanced oxidation processes.
- Chemical recycling of polyethylene terephthalate PET.
- Toxicity test with *Vibrio Fischeri*.
- Spectroscopic characterisation (ATR FTIR and Raman analysis, UV/VIS analysis).
- Spectroscopic characterisation at the micro level (FTIR-microscopy).
- General characterisation of waters: determination of hardness, pH, electrical conductivity, turbidity, colouration, chemical oxygen demand (COD), biochemical oxygen demand (BOD) and total organic carbon (TOC) values, and determination of volatile lipophilic substances (TLS).

#### COOPERATION WITH RESEARCH AND OTHER INSTITUTIONS

- Faculty of Polymer Technology, Slovenj Gradec, Slovenia
- BOKU – University of Natural Resources and Life Sciences, Vienna, Austria
- University of Belgrade, Belgrade, Serbia
- University of Niš, Niš, Serbia
- University of Zagreb, Zagreb, Croatia
- Academy of Professional Studies South Serbia, Leskovac, Serbia
- Technical University of Lodz, Lodz, Poland
- INTI-National Institute of Industrial Technology, Buenos Aires, Argentina
- Pamukkale University, Pamukkale/DENIZLI, Turkey
- Bursa Uludag University, Nilüfer/BURSA, Turkey
- Ege University, Bornova – IZMIR, Turkey

#### COOPERATION WITH COMPANIES

American & Efird (A&E Europe), d.o.o., Ecolab, d.o.o., Konus Konex, d.o.o., Paloma, d.d., Styrian Chamber of Commerce, IOS Institute for Environmental Protection and Sensors, d.o.o., Filc, d.o.o., Ikema, d.o.o., ECHO, d.o.o., Plastika Skaza, d.o.o.

### MOST IMPORTANT RESEARCH ACHIEVEMENT

The RESYNTAX project is a direct contribution to the EU Waste Directive 2008 (2008/98/EC). **It deals with a unique technology for processing textile waste** based on the cascading of chemical and enzymatic processes to produce secondary raw materials, mainly for the chemical and textile industries. The project developed innovative business models that can be adapted to different industrial partnerships and new markets. By involving the wider community, we aimed to improve current approaches and attitudes to textile waste collection, raise public awareness and spread awareness of the need for recycling.

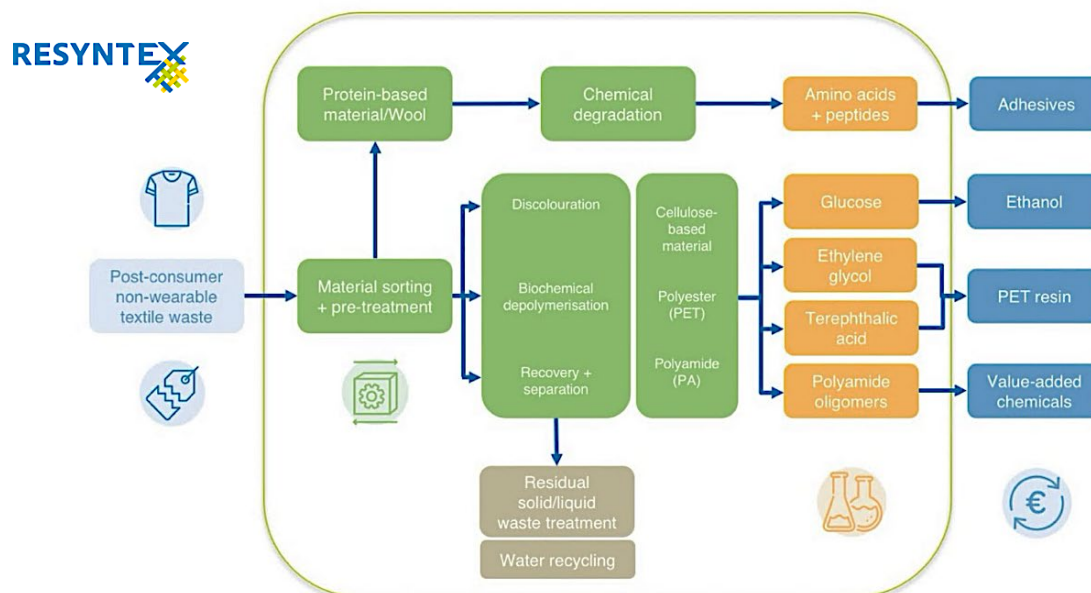

### PUBLICATIONS

1. PLOHL, Olivija, ERJAVEC, Alen, FRAS ZEMLIJČ, Lidija, VESEL, Alenka, ČOLNIK, Maja, ŠKERGET, Mojca, VAN FAN, Yee, ČUČEK, Lidija, TRIMMEL, Gregor, VOLMAJER VALH, Julija. Morphological, surface and thermal properties of polylactic acid foils, melamine-etherified resin, and polyethylene terephthalate fabric during (bio)degradation in soil. *Journal of Cleaner Production*. [Online ed.]. Available online 23 August 2023, 138554, str. 50, illustr. ISSN 1879-1786. DOI: 10.1016/j.jclepro.2023.138554.
2. VOLMAJER VALH, Julija, PUŠIČ, Tanja, ČURLIN, Mirjana, KNEŽEVIČ, Ana. Extending the protection ability and life cycle of medical masks through the washing process. *Materials*. Feb. 2023, vol. 16, iss. 3, [article no.] 1247, str. 18. ISSN 1996-1944. DOI: 10.3390/ma16031247.
3. VUJANOVIČ, Annamaria, PUHAR, Jan, ČOLNIK, Maja, PLOHL, Olivija, VIDOVIČ, Timotej, VOLMAJER VALH, Julija, ŠKERGET, Mojca, ČUČEK, Lidija. Sustainable industrial ecology and environmental analysis: a case of melamine etherified resin fibres. *Journal of Cleaner Production*. [Print ed.]. 1 Oct. 2022, vol. 369, str. 13. ISSN 0959-6526. DOI: 10.1016/j.jclepro.2022.133301.
4. VOLMAJER VALH, Julija, STOPAR, Dimitrije, SELAYA BERODIA, Ignacio, ERJAVEC, Alen, ŠAUPERL, Olivera, FRAS ZEMLIJČ, Lidija. Economical chemical recycling of complex PET waste in the form of active packaging material. *Polymers*. Aug. 2022, vol. 14, iss. 16 (3244), str. 1–15. ISSN 2073-4360. DOI: 10.3390/polym14163244.
5. ERJAVEC, Alen, VOLMAJER VALH, Julija, HRIBERNIK, Silvo, KRAŠEVAC GLASER, Tjaša, FRAS ZEMLIJČ, Lidija, VUHERER, Tomaž, NERAL, Branko, BRUNČKO, Mihael. Advance analysis of the obtained recycled materials from used disposable surgical masks. *Polymers*. March 2024, vol. 16, iss. 7, [article no.] 935, str. 21, illustr. ISSN 2073-4360. DOI: 10.3390/polym16070935.

### PATENTS AND PATENT APPLICATIONS

- VOLMAJER VALH, Julija, TOPLAK ČASAR, Renata, MAJCEN LE MARECHAL, Alenka, NOVAKOVIČ, Srdjan. N-chlorobenzopiran-2-imine derivatives and their uses: Patent No. SI 21269 A, dated 02.03.2004: Patent Application No. P-200200167, application date 02.07.2002. Ljubljana: Intellectual Property Office of the Republic of Slovenia, 2004. 8, p. 2, graph, display.

ARIS RESEARCH PROGRAMME P2-0118 Textile Chemistry and Advanced Textile Materials



### NATIONAL AND INTERNATIONAL PROJECTS

- Planning and managing sustainable value chains of plastic material production for the transition to a circular economy. J7-3149, 2021 - 2024.
- Resyntex: A new circular economy concept: from textile waste towards chemical and textile industries feedstock. H2020-WASTE, 2015 - 2019.

### MEMBERSHIPS

- AUTEX - Association of Universities for Textile
- EURATEX - European Technology Platform for the Future of Textiles and Clothing

## 6.3 LABORATORY FOR CHARACTERISATION AND PROCESSING OF POLYMERS



*Head of the Laboratory*  
**Prof. Lidija Fras Zemljič**  
 E-mail: [lidija.fras@um.si](mailto:lidija.fras@um.si)  
 Tel.: +386 2 220 7909  
 Web: <https://lcpp.fs.um.si/>

The excellent personnel and infrastructure structure of the laboratory enables scientific research and development work in the fields of polymers, textile materials and technologies. We focus primarily on advanced functionalisation and characterisation of polymeric materials, with special attention paid to textile materials and composites. The aim of our research is to develop smart and (multi)functional textiles, nanofibres and polymer composites for various purposes, such as bioactive packaging, medical and engineering applications. In doing so, we are starting from the horizontal integration of nano- and biotechnologies and are developing a (new) concept of closed-loop waste and environmentally friendly materials. We have expert knowledge and analytical tools for determining the physicochemical properties of polymer materials, and we focus on the analysis of surfaces and surface phenomena, and on an in-depth understanding of the interactions on the intermediate surfaces between solid and liquid and solid and gaseous.

### MAJOR RESEARCH EQUIPMENT



#### LITESIZER 500 Anton Paar

The Litesizer 500 is an excellent choice for determining the properties of nano- and microparticles in dispersions and solutions. The particle size is determined by the dynamic method (DLS) and the zeta potential by the electrophoretic light scattering method (ELS).



#### TITRATORS T70, DL53, DL28 Mettler Toledo

Titration techniques: potentiometric, conductometric, and polyelectrolyte titrations are used commonly to determine the charge of charged monomers and polymers in solutions or suspensions (fibres, cellulose, foils, membranes, etc.) and the type of dissociating and surface accessible groups, the dissociation constant (pK values) in solvents of different polarities.



#### SURPASS 3 Anton Par

The SurPASS 3 instrument is used to analyse the zeta potential of solids of almost any shape and size, such as fibres, foils, plates, textiles, powders or granules. The principle of zeta potential analysis with the SurPASS 3 instrument is based on the flow potential and flow current method. Adsorption experiments can also be done with this machine.



### Quartz Microbalance with Dissipation Biolin Scientific

A quartz microbalance with dissipation is a device that analyses surface phenomena, including thin film formation, interactions and reactions, at the nanoscale and in real time. It can be used to monitor the adsorption/desorption behaviour in real time at the solid-liquid intermediate phase.



### 3D BIO-printer GeSiM BioScaffolder GeSiM Bioinstruments and Microfluids

Bioscaffolder is a unique 3D bioprinter that allows simultaneous printing of cell carriers and living cells. It uses two different technologies, pneumatic extrusion and piezoelectric printing.



### Nanospider NS 500 Elmarco

The nano-fronting device enables the so-called needle-free formation of nanofibres from a viscous polymer solution using a strong electrostatic field. This enables the production of nanofibrous structures (coprene), useful e.g., in medicine as wound dressings or air filters, etc.



### SEM with EDXS- SUPRA 35 VP Carl Zeiss

#### EDXS spectrometer Ultim Max 100 Oxford, VB

A line electron microscope (FESEM) for the analysis of the morphology, topography and chemical composition characteristics of many types of materials. The advantages of the GEMINI® FESEM column system is excellent resolution up to very low voltages of 0.1 kV and a high-performance secondary electron detector, which enables the analysis of sensitive, poorly conductive samples, such as polymers and biological samples. In combination with energy dispersive X-ray spectroscopy (EDXS), it allows the determination of chemical composition.



### Spectrometer Spectrum 3 Tri-Range MIR/NIR/FIR PerkinElmer Microscopic System Spotlight 200i FT-IR, GladiATR Illuminate

It enables operation in medium, near and far infrared light. The Spectrum 10 software package controls the Spotlight 200i system, enabling advanced FT-IR analysis. The combined system is ideal for the analysis of functional groups and molecules of inorganic, organic, or composite materials. It enables the observation of microfibre cross-sections and the analysis of ATR-FTIR samples in situ, as well as the mapping of specific material components.

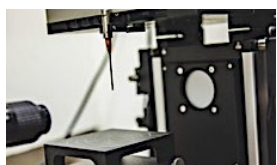

### Goniometer OCA 35 Data Physics

It enables the measurement of contact angle on flat surfaces of different solid materials using different liquids, which allows the determination of the surface free energies of materials and information on the behaviour of surfaces in contact with different liquids and their hydrophilic/hydrophobic character.



### Experimental system for assembling nano- and microstructural polymer composites and metal glass, ThermoFisher Scientific process 11 extruder

The experimental system for the assembly of nano- and microstructural polymer composites enables basic research in the field of the Synthesis of Polymer Composites (thermoplastics with nanofillers).

#### SERVICE OFFER AND SUPPORT TO THE ECONOMY

- Techniques of production and modification of materials, development of functional materials (various devices for electric spinning and electrospinning, inkjet printer, biosuit (3D-bioprinter), device for spin-coating and dip-coating, plasma activation, UV etching, freezing dryer, rotavapor, encapsulator, spray dryer, pyrolysis furnace, homogeniser, fibre optic welding machine, conventional impregnation process and diving process).
- Morphology, structuring of polymeric materials (AFM, SEM with EDXS, etc.).
- Surface properties and study of the adsorption/desorption phenomena of polymer materials and polymer composite materials: (QCM-D, electrophoretic mobility and particle sizing, titrations, surface zeta potential, tensiometry/goniometry, UV-VIS, ATR-IR and Raman spectroscopy, water/vapour sorption).
- Chemical composition of materials (SEM by EDX, ATR-IR).
- Conventional analysis and testing of textile materials (fibres, yarns and flat textiles) according to the standards. Analyses of other polymeric materials and composites (films, foils, membranes) and polymer solutions. These analyses include chemical composition, structure and morphology, rheological properties, physicochemical and mechanical properties, combustibility, degradation and/or changes in colour and appearance under different atmospheric conditions, etc.
- Analysis and planning of classical and modern finishing and coating processes.
- Production of advanced thermoplastic composite materials.

#### COOPERATION WITH RESEARCH AND OTHER INSTITUTIONS

- Jožef Stefan Institute, Ljubljana, Slovenia
- Institute of Chemistry, Ljubljana, Slovenia
- Faculty of Polymer Technology, Slovenj Gradec, Slovenia
- Graz University of Technology, Graz, Austria
- Karl Franzens University of Graz, Graz, Austria
- Montanuniversität Leoben, Leoben, Austria
- Lund University, Lund, Sweden
- University of Nottingham, Nottingham, United Kingdom
- University of Evry-Val-d'Essonne, Evry, France
- Leibniz Institute of Polymer Research Dresden, Dresden, Germany
- ETH - Swiss Federal Institute of Technology Zürich, Switzerland
- LEPMI - Laboratory of Electrochemistry and Physical-Chemistry of Materials and Interfaces, France
- AIDICO - Technological Institute for Construction, Valencia, Spain
- BOKU - University of Natural Resources and Life Sciences, Vienna, Austria
- CEMEF - Centre for Forming Materials, Sophia Antipolis, France
- Joanneum Research, Graz, Austria
- TITK - Thuringian Institute for Textile and Plastics Research, Rudolstadt, Germany
- Innochemtech GmbH Braunschweig, Braunschweig, Germany
- The Aristotle University of Thessaloniki, Thessaloniki, Greece
- AIMPLAS - Technological Institute of Plastics, Valencia, Spain
- University of Belgrade, Belgrade, Serbia
- University of Zagreb, Zagreb, Croatia



### COOPERATION WITH COMPANIES

Tosama, d.o.o., Perutina Ptuj, d.d., Konas Konex, d.o.o., Medex, d.d., T. T. Okroglica, d.d., Tick, d.o.o., Paloma, d.d., Kogal, s.p., Silkem, d.o.o., Savatech, d.d., Jata Emona, d.d., Mondi AG, Tekstina, d.o.o., Surovina d.o.o., Kinezika, d.o.o., Calcit, d.o.o., Cinkarna Celje, d.o.o., Weiler Abrasives, d.o.o., Treibacher Industry AG, Falpe s.r.l. Unipersonale, ...

### MOST IMPORTANT RESEARCH ACHIEVEMENT

- Development of functional polypropylene layers with chitosan and cationised cellulose nanofibrils for inclusion in a three-layer face mask with potential antiviral activity. Preparations made of chitosan and cationised cellulose nanofibrils (individually or as a mixture) were silk-screen printed on a layer of a polypropylene mask, and a biopolymer-modified functional layer was incorporated into a three-layer face mask and provided antiviral properties.

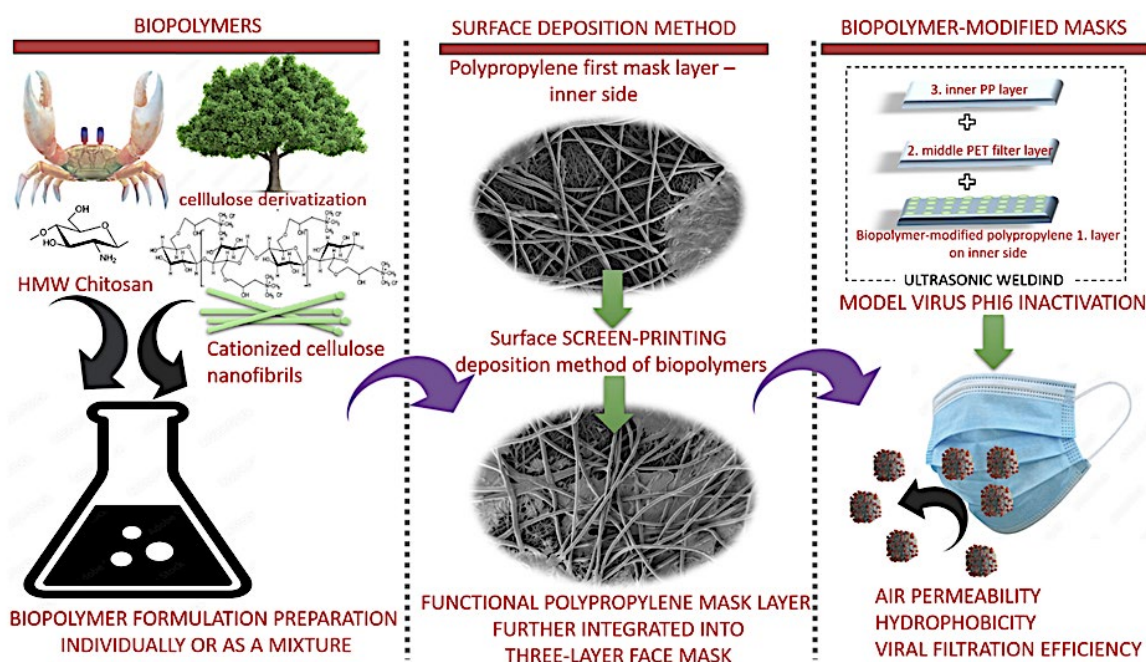

- Amoxicillin-doped hyaluronic acid/fucoidan as multi-purpose coatings for medical orthopaedic stainless-steel implants with excellent medical potential.

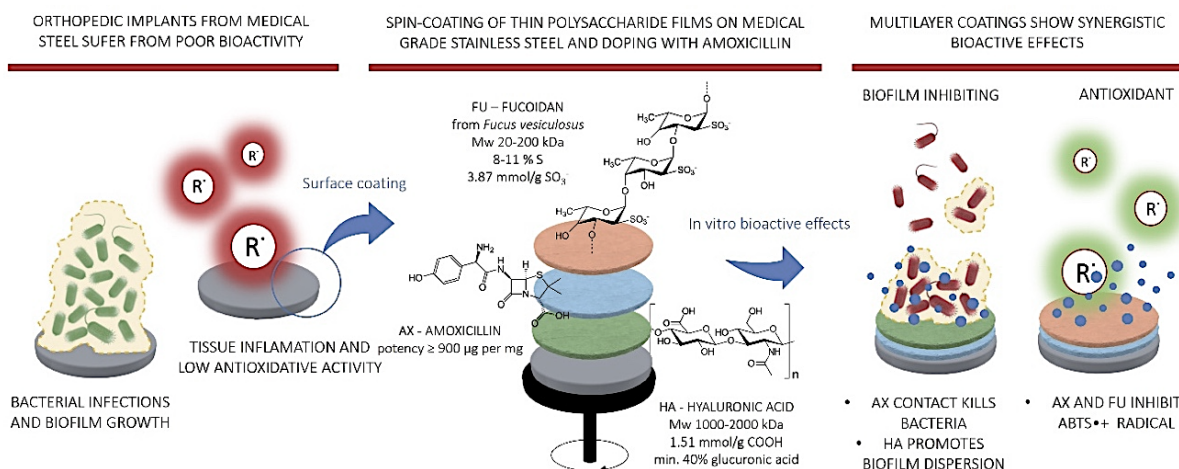

### PUBLICATIONS

- BRAČIČ, Matej, POTRČ, Sanja, FINŠGAR, Matjaž, GRADIŠNIK, Lidija, MAVER, Uroš, BUDASHEVA, Hanna, KORTE, Dorota, FRANKO, Mladen, FRAS ZEMLIČ, Lidija. Amoxicillin doped hyaluronic acid/fucoidan multifunctional coatings for medical grade stainless steel orthopaedic implants. *Applied Surface Science*, 2023, vol. 611, part A, str. 1–11, doi: 10.1016/j.apsusc.2022.155621.



2. AJDNIK, Urban, LUXBACHER, Thomas, FRAS ZEMLIČ, Lidija. *Proteins at polysaccharide-based biointerfaces: A comparative study of QCM-D and electrokinetic measurements. Colloids and Surfaces. B, Biointerfaces*, 2023, vol. 221, str. 1–10, doi: 10.1016/j.colsurfb.2022.113011.
3. PLOHL, Olivija, KOKOL, Vanja, FILIPIČ, Arijana, FRIC, Katja, KOGOVŠEK, Polona, PERŠIN FRATNIK, Zdenka, VESEL, Alenka, KUREČIČ, Manja, ROBIČ, Jure, GRADIŠNIK, Lidija, MAVER, Uroš, FRAS ZEMLIČ, Lidija. *Screen-printing of chitosan and cationised cellulose nanofibril coatings for integration into functional face masks with potential antiviral activity. International Journal of Biological Macromolecules*, 2023, vol. 236, str. 1–15, doi: 10.1016/j.ijbiomac.2023.123951.
4. FRAS ZEMLIČ, Lidija, ČOLNIK, Maja, FAKIN, Darinka, PUŠIČ, Tanja, BRAČKO, Vanessa Wendy, KRAŠEVAC GLASER, Tjaša, ŠKERGET, Mojca. *Eco friendly functional finishes of polyester fabric using keratin from wool and feather wastes. Progress in Organic Coatings. [Online ed.]*. Sept. 2024, vol. 194, [article no.] 108616, str. 1–12, doi: 10.1016/j.porgcoat.2024.108616.
5. PLOHL, Olivija, FRAS ZEMLIČ, Lidija, VIHAR, Boštjan, VESEL, Alenka, GYERGYEK, Sašo, MAVER, Uroš, BAN, Irena, BRAČIČ, Matej. *Novel magnetic iron oxide-dextran sulphate nanocomposites as potential anticoagulants: Investigating interactions with blood components and assessing cytotoxicity. Carbohydrate Polymers*. Nov. 2024, vol. 343, [article no.] 122469, str. 1–13, doi: 10.1016/j.carbpol.2024.122469.

#### PATENTS AND PATENT APPLICATIONS

- KRAŠEVAC GLASER, Tjaša, MOZETIČ, Miran, OGRINC, Nives, VESEL, Alenka, FRAS ZEMLIČ, Lidija. Film and production method: Patent Application GB 2584438 A. [S. I.]: Intellectual Property Office, 9 Dec 2020.

#### ARIS RESEARCH PROGRAMME P2-0118 Textile Chemistry and Advanced Textile Materials

#### NATIONAL AND INTERNATIONAL PROJECTS

- Development of a highly sensitive electrochemical method based on magnetic polymer nanocomposites for the determination of trace amounts of antibiotic compounds in environmental systems. 10.1.2022 - 30.9.2025.
- Advanced technological processes for the recycling of waste keratin biomass and the development of new functional bioproducts based on keratin. 10.1.2022 - 30.9.2025.
- Development of safe multi-purpose surfaces for catheters to prevent the formation of biofilms (DemoCat). 10.01.2021 - 30.09.2024.
- Planning and managing sustainable value chains of plastic material production for the transition to a circular economy. 11.01.2021 - 31.10.2024.
- Development of bioactive nanostructured fibrous membranes for prolonging the quality of fresh fruit. 01.09.2020 - 31.08.2023.
- Strategy for improving the quality of life and orthopaedic treatment of cartilage injuries – advanced 3D (bio)printed supports for tissue regeneration. 01.09.2020 - 31.08.2023.
- FoodTraNet - Advanced research and Training Network in Food quality, safety, and security. H2020-MSCA-ITN, 1.5.2021 - 30.4.2025.
- FiberNet. H2020-MSCA-ITN, 1.1.2018 - 31.5.2022.

#### MEMBERSHIPS

- EPNOE - European Network of Excellence for polysaccharide
- POLIMAT - Centre of Excellence Polymer Materials and Technologies
- AUTEX - Association of Universities for Textile
- EURATEX - European Technology Platform for the Future of Textiles and Clothing
- Textile ETP - The European Technology Platform for the Future of Textiles and Clothing
- E-RIHS - European research infrastructure for heritage science

## 6.4 LABORATORY OF CLOTHING ENGINEERING, PHYSIOLOGY AND GARMENT CONSTRUCTION



**Head of the Laboratory**  
**Prof. Jelka Geršak**  
 E-mail: [jelka.gersak@um.si](mailto:jelka.gersak@um.si)  
 Tel: +386 2 220 7960  
 Web: <https://ricdoi.fs.um.si/o-nas/ricdoi/loifko/>



The Laboratory for Clothing Engineering, Physiology and Garment Construction was formally established in 1999, and its genesis dates to 1985, when the Laboratory for Clothing Technology was founded, which was renamed the Laboratory for Clothing Engineering in 1992. The core activities of the laboratory are educational and research activities. The research is an important and visible part of the activities carried out within the Research Programme *Clothing Science, Comfort and Textile Materials*, and provides a theoretical and applied basis for the development of new research directions in the field of mechanical behaviour of flexible structures, functional, smart and intelligent clothing, comprehensive provision of comfort when wearing clothing and clothing heritage science. An important part of the research focuses on the development of an intelligent clothing with an integrated personalisable wearable system, designed based on artificial intelligence techniques, for on-line freezing of gait detection and cueing in real time, designed for patients with Parkinson's disease experiencing freezing of gait episodes. The laboratory is equipped with modern equipment for objective evaluation of the mechanical and physical properties of flexible flat structures by small tensile, shear, compression, and bending stresses, thermal properties, a CAD system for the garment construction and simulation of clothing, and other textile products in a virtual environment, a 3D body scanner for three-dimensional acquisition of the dimensions and shape of the human body, and other supporting infrastructure.

### MAJOR RESEARCH EQUIPMENT

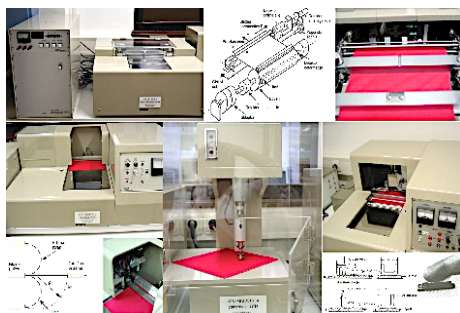

#### KES-FB AUTO measuring system Katō Tech Co., Ltd., Japan

It is used to determine the mechanical behaviour of flat textiles (fabrics, knitted fabrics, nonwovens, laminates) at low loads and surface properties, and enables the analysis of complete reversible deformations caused by small tensile, shear, bending and compression stresses. The system also enables the measurement of the mechanical behaviour of non-textile materials such as leather, paper, membranes, foils and other flexible flat materials.

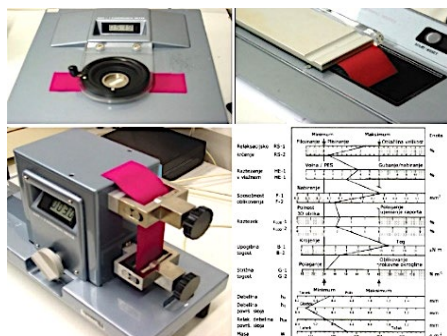

#### FAST measuring system, CSIRO Division of Wool Technology, Australia

The measuring system is used to control the mechanical properties in the manufacture of fabrics, in finishing and in the control of clothing production processes. It is based on the technology of objective evaluation of mechanical properties at low loads and dimensional stability as a physical property. The results are based on 14 parameters (compression, bending, tensile and shear properties, formability and dimensional stability) and a FAST control chart that indicates potential problems in the garment manufacturing process.



#### KES-FB7 ThermoLabo II, Katō Tech Co., Ltd., Japan

ThermoLabo is a measuring system for determining the thermal properties of flat textiles and other flat materials as important parameters of biophysical analysis of clothing systems. It is a system that simulates the transfer of heat and/or water vapour through flat textiles or other materials, and is used to determine the thermal conductivity  $\lambda$ , thermal resistance  $R_{ct}$  and water vapour resistance  $R_{et}$ , water vapour permeability index  $i_{mt}$ , heat retention coefficient and warm-cold feeling  $q_{max}$  when the fabric is in contact with the skin.

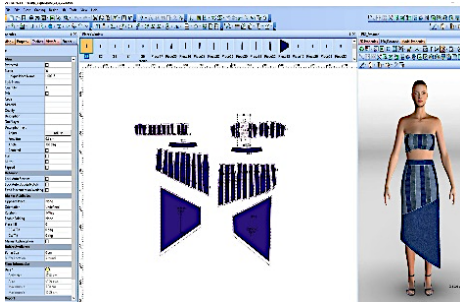

#### OptiTex PDS, Optitex Ltd., Israel

OptiTex PDS is a CAD garment pattern design software that, with the support of the 3D module, enables the simulation of clothing in a virtual environment and their fitting on virtual 3D body models. The software with the so-called *Fabric Editor* enables the conversion of parameters of mechanical and physical properties of textiles, measured with the KES-FB or FAST measuring system, into a form suitable for 3D simulation of textile draping and simulation of 3D clothing prototypes in a virtual environment.



#### Computer-controlled climate chamber, IZR, Škofja Loka, Slovenia

The climate chamber with a cooling and heating unit and a video monitoring system is intended for studying the thermophysiological stress of test subjects under various thermal environmental loads or for studying the physiological responses of the human body during various activities: during movement (casual clothing, summer clothing, business clothing, sports clothing), during sleep (mattresses, sleeping bags), while driving (car seat covers), and/or at work (work and protective clothing) and under various environmental conditions. From a research point of view, it is an important part of the infrastructure, that makes it possible to evaluate the effects of the thermal environment on the user's thermal well-being when wearing individual clothing systems under certain artificially created climatic conditions that simulate the real environment...

### SERVICE OFFER AND SUPPORT TO THE ECONOMY

- Analysis of the quality parameters of textiles and clothing: Analysis of the parameters of mechanical and physical properties of flat flexible materials (flat textiles, leather, paper, foils, etc.) determined with the KES-FB and FAST measuring system, determination of thermal properties (thermal resistance  $R_{ct}$ , or water vapour resistance  $R_{et}$ , thermal conductivity of flat textiles  $\lambda$ ).
- Determination of the parameters of thermophysiological comfort when wearing clothing (evaluation of thermal stress using physiological measurements) under different climatic conditions.
- Construction of basic pattern and modeling of clothing pattern-pieces, grading of pattern-pieces, virtual prototyping of clothing.
- Conventional analysis and testing of textile materials (threads, woven and knitted fabrics, clothing) according to standards.
- We also carry out the design of textiles and clothing and provide expertises on the causes of problems in the clothing manufacturing process, and visual assessment of the quality of the clothing produced, etc.

### COOPERATION WITH RESEARCH AND OTHER INSTITUTIONS

- Heriot-Watt University, Edinburgh, United Kingdom
- Nottingham Trent University, Nottingham, United Kingdom
- Technical University of Dresden - Institute of Textile Machinery and HighPerformance Material Technology, Dresden, Germany
- Academy of Fine Arts and Design in Bratislava, Slovakia
- University of Zagreb, Faculty of Textile Technology, Zagreb, Croatia
- University of Hradec Králové, Faculty of Education, Hradec Králové, Czech Republic
- Lodz University of Technology, Faculty of Material Technologies and Textile Design, Lodz, Poland
- Technical University of Liberec, Faculty of Textile Engineering, Liberec, Czech Republic
- University of Arts in Belgrade, Faculty of Applied Arts, Beograd, Serbia
- University of Novi Sad, Technical Faculty "Mihajlo Pupin" Zrenjanin, Zrenjanin, Serbia
- University of Sarajevo, Academy of Fine Arts, Sarajevo, Bosnia and Herzegovina

- University of Bihać, Technical Faculty, Bihać, Bosnia and Herzegovina
- University of Banja Luka, Faculty of Technology, Banja Luka, Bosnia and Herzegovina
- University of Niš, Faculty of Technology in Leskovac, Leskovac, Serbia
- Óbuda University, Rejtő Sándor Faculty of Light Industry and Environmental Engineering, Budapest, Hungary
- Vilnius Academy of Arts, Vilna, Lithuania
- National Research and Development Institute for Textiles and Leathers (INCDTP), Bucharest, Romania
- Ghent University, Ghent, Belgium
- Hogeschool Ghent (HOOGENT), Ghent, Belgium
- Ecole Nationale Supérieure Arts Industries Textiles (ENSAIT), Roubaix, France
- TecMinho, Interface of the University of Minho, Guimaraes, Portugal
- Technological Centre for the Textile and Clothing Industries of Portugal, Vila Nova de Famalicão, Portugal
- Gheorghe Asachi Technical University of Iasi, Iasi, Romania
- University of Ljubljana, Faculty of Natural Sciences, Ljubljana, Slovenia
- University of Ljubljana, Faculty of Medicine, Ljubljana, Slovenia
- 

#### COOPERATION WITH COMPANIES

Lisca, d.o.o., Sevnica, Prevent&Deloza, d.o.o., Celje; Mavisa, d.o.o., Trzin, International Institute for Consumer Research, Ljubljana, Slovenian Railways - Passenger Transport, Ltd., Ljubljana, Association of Paraplegics of Slovenia, Association of Paraplegics of Podravje, Regional Museum Maribor, Regional Museum Ptuj - Ormož, ...

#### MOST IMPORTANT RESEARCH ACHIEVEMENT

**Development of a wearable system capable of monitoring, analysing and recognising human gait activity**, with the aim of improving the quality of life in patients with Parkinson's disease, in the fields of sports or prosthetics. Gait motion information is acquired using accelerometers and gyroscopes mounted on the lower limbs, where the sensors are exposed to inertial forces during gait. The system consists of the following components: a gait motion data acquisition system, i. e. motion information, a time-series data collection, data pre-processing and data processing (classification).

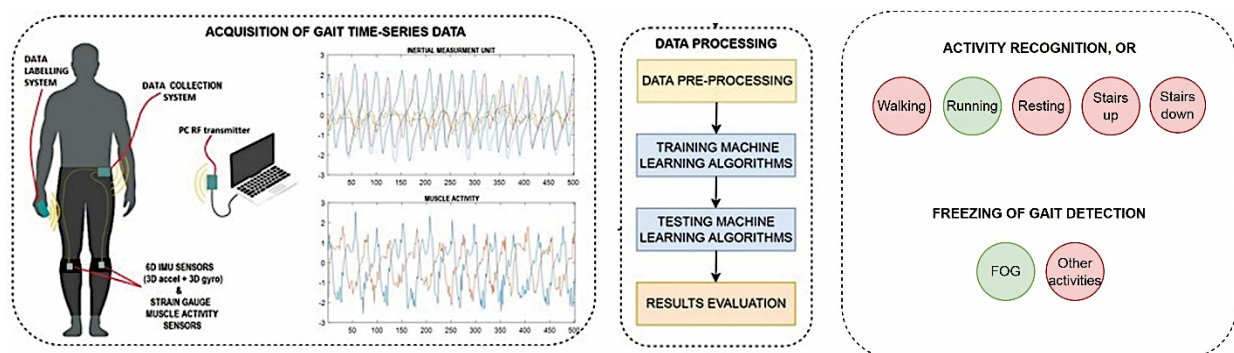

With the use of the hardware and software developed, it will be possible to accurately and reliably detect freezes (freezing of gait episodes) in patients with Parkinson's disease in real time, which will contribute to a more objective assessment of the patient's condition and influence the quality of disease progression and treatment.

#### PUBLICATIONS

1. GERŠAK, J. *Design of clothing manufacturing processes: a systematic approach to developing, planning, and control*. 2nd ed. Oxford: Woodhead Publishing: Elsevier, cop. 2022. XIII, str. 375, *The Textile Institute book series*. ISBN 978-0-08-102648-9, ISBN 978-0-08-102772-1.
2. SLEMENŠEK, J., FISTER, I., GERŠAK, J., BRATINA, B., VAN MIDDEN, V. M., PIRTOŠEK, Z., ŠAFARIČ, R. *Human gait activity recognition machine learning methods*. *Sensors*. 2023, vol. 23, iss. 2, 745, str. 1–24. ISSN 1424-8220. DOI: 10.3390/s23020745.



3. RUDOLF, A., ŠTERMAN, S., CUPAR, A. Development of a textile sheet mask design for facial care based on a 3D face model of an average woman. *Journal of Engineered Fibers and fabrics*. April 2024, vol. 19, str. 14. ISSN 1558-9250. DOI: 10.1177/15589250241254443.
4. STOJANOVIĆ, S., GERŠAK, J., URAN, S. Development of the Smart T-Shirt for Monitoring Thermal Status of Athletes. *AUTEX Research Journal*, vol. 23, no. 2, 2023, str. 266–278. <https://doi.org/10.2478/aut-2022-0005>.
5. BOBOVČAN MARČELIČ, M., GERŠAK, J., ROGALE, D., FIRŠT ROGALE, S. Study of the compression properties of welded seams formed using hot wedge, hot air, ultrasonic, and high-frequency welding techniques. *Textile Research Journal*. 2022; 92(23–24), str. 4736–4752. ISSN 0040-5175. DOI: 10.1177/00405175221109637.

#### PATENTS AND PATENT APPLICATIONS

- GERŠAK, J. Measuring System for Programmed Measurement and Evaluation of Mechanical Properties of Linear and Flat Flexible Materials: Patent No. SI 23645 A, Date of Publication 31.8.2012; Patent Application No. P-201200162, date of filing of the application 24.5.2012. Ljubljana: Ministry of Economic Development and Technology, Intellectual Property Office of the Republic of Slovenia, 2012.
- GERŠAK, J. Intelligent Functional Jacket for the Injury Detection with Partial Puncture Protection Function: Patent Grant Decision: Patent No. 22644, 30.4.2009; application number P-200800294 dated 01.12.2008. Ljubljana: Intellectual Property Office of the Republic of Slovenia, 2009.

#### ARIS RESEARCH PROGRAMME P2-0123 Clothing Science, Comfort and Textile Materials

#### NATIONAL AND INTERNATIONAL PROJECTS

- ARACNE – Advocating the Role of silk Art and Cultural Heritage at the National and European scales. HORIZON-CL2-2022-HERITAGE-01, 1. 3. 2023–28. 2. 2026.
- DigitalFashion – Collaborative Online International Learning in Digital Fashion. Erasmus+ KA220-HED, 1. 2. 2022–31. 1. 2025.
- Big going Small. Erasmus+ KA210-VET3E10A3FF, 1. 1. 2024–31. 12. 2025.
- Software tools for textile creatives. Erasmus+ KA203-079823, 1. 12. 2020–30. 11. 2022.
- Ars-Techne - Creative Design and Innovation. CEEPUS Network SI-0217-17-2324.
- Ars-Techne: Creative Design and Innovation. CEEPUS Network SI-0217-18-2425.

#### MEMBERSHIPS

- AUTEX - Association of Universities for Textile
- Textile ETP - European Technology Platform for the Future of Textiles and Clothing
- PPE for Pesticide - International Consortium for the Development and Evaluation of PPE for Pesticide Operators and Re-entry Workers
- IPC E-Textiles Committee Europe Working Groups for E-Textiles Standards
- HATZ - Croatian Academy of Engineering

#### 6.5 LABORATORY FOR FABRIC PLANNING AND CONSTRUCTION



*Head of the Laboratory*

**Assoc. Prof. Polona Dobnik Dubrovski**

E-mail: [polona.dubrovski@um.si](mailto:polona.dubrovski@um.si)

Tel: +386 2 220 7942

Web: <https://www.fs.um.si/laboratorij-za-projektiranje-in-konstrukcijo-tekstilij/>

The laboratory's research activity includes fundamental, applied, and R&D work, focusing on the field of Textile-Mechanical Processes (ARIS classification) or Textile Technology (CERIF classification). The research work focuses on the planning and constructing of linear and flat textiles for different applications (clothing, interiors and technical applications). We also work on the modernising flat textile production processes, particularly the digitalisation of weaving preparation. Important thematic areas of our research include mechanical and physical properties planning of classical and technical textiles, auxetic textiles and other flexible engineering materials,

such as foams, rubbers, gels, composites and the like. In addition, we carry out porosity analysis of textile and other engineering materials and functional property modelling of textiles, as well as updating the process of sampling and constructing of dobby and jacquard fabrics.

#### MAJOR RESEARCH EQUIPMENT



**Force Testing System H10KT Tinius Olsen.** The system enables the measurement of the mechanical properties of linear (yarns, threads, tapes, ropes) and flat (woven fabrics, knitted fabrics, non-woven fabrics, compound fabrics) textiles and non-textile materials, such as paper, leather, plastic, rubber, composites, gels, etc. The system currently enables the analysis of the behaviour of materials under tensile and compressive loads up to 50 N, 1000 N and higher loads, up to 10 kN, making it particularly suitable for testing technical materials such as conveyor belts, belts, laminates, geotextiles, etc. in accordance with the relevant Standards.



#### Mercury Porosimeter Pascal

The 140/440 instrument is used to analyse the porosity of solid materials. It operates at lower Hg injection pressures (up to 400 kPa), and is suitable for measuring the porosity of macro and mesoporous solids with pore size classes ranging from 900  $\mu\text{m}$  to 3.8  $\mu\text{m}$ , or at higher Hg injection pressures (up to 400 MPa), and is suitable for measuring the porosity of microporous solids with pores in the pore size class from 5  $\mu\text{m}$  to 3.6 nm.



#### Image Analysis System Lucia Optoteam

The system enables the capture, analysis and archiving of microscopic images of test samples of linear and flat textiles. It is suitable for both translucent and opaque samples. It enables the capture and processing of image information (measurements of details in the image (length, width, area, circumference...), determination of the characteristics of textile materials (systematics of effects, structure, defects), determination of the shape and distribution of pores in flat textiles, determination of the type of defects in yarns/threads and flat textiles.

#### SERVICE OFFER AND SUPPORT TO THE ECONOMY

- Analysis of the behaviour of linear and flat textiles and other materials (plastics, rubber, paper, leather, composites, gels, etc.) under tensile and compressive loads, according to the protocols in respect to various Standards. The ability to transfer research data in the form of an Excel file.
- Image analysis of linear and flat textiles (determination of the surface characteristics of textile materials (yarns, threads and flat textiles), determination of the shape and distribution of pores in flat textiles, determination of the type of defects in yarns, threads and flat textiles).
- Determination of the constructional parameters of woven fabrics (direction of twisting in the yarn extracted from the fabric; type of weave and its notation in numerical form, making a weave pattern, number of threads per unit of length; thickness of fabric; mass of fabric).
- Determination of the porosity parameters of engineering materials that withstand certain pressures of mercury injection.

#### COOPERATION WITH RESEARCH AND OTHER INSTITUTIONS

- University of Ljubljana, Faculty of Natural Sciences and Engineering, Ljubljana, Slovenia
- University of Zagreb, Faculty of Textile Technology, Zagreb, Croatia
- IIT - Indian Institut of Technology Delhi, Department of Textile & Fibre Engineering, New Delhi, India
- NIT - National Institut of Technology Jalandhar, Department of Textile Technology, Jalandhar, India
- Kafrelsheikh University, Faculty of Specific Education, Kafr El Sheikh, Egypt

## COOPERATION WITH COMPANIES

Konus Konex, d.o.o., Keltex, d.o.o., Predilnica Litija, d.d., Tekstina, d.d., Tosama, d.o.o.

## MOST IMPORTANT RESEARCH ACHIEVEMENT

**Development of functional non-woven fabrics with auxetic properties.** Using the geometry of rotating square cells, we have developed modified classic non-woven textiles used in the footwear industry with auxetic properties. Due to their auxetics, such materials are easier to shape or model into various forms, thus enabling a better fit to the mould, while, at the same time, they do not shrink under tensile loads but expand. This allows for more comfortable footwear, because, for example, in the case of a swollen foot, the footwear "expands" in proportion to the size of the swelling of the instep.

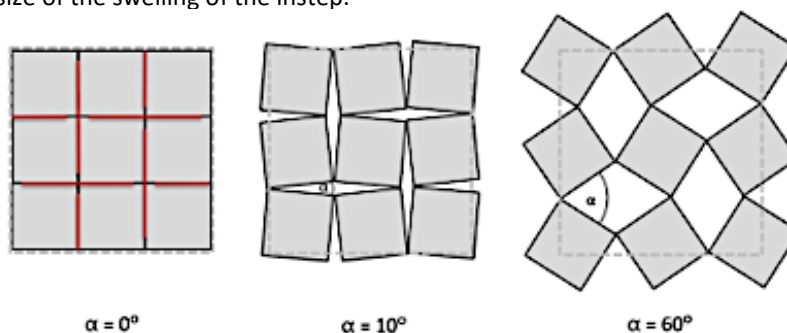

## PUBLICATIONS

1. DOBNIK-DUBROVSKI, Polona, NOVAK, Nejc, BOROVIŠEK, Matej, VESENJAK, Matej, REN, Zoran. In-plane deformation behaviour and the open area of rotating squares in an auxetic compound fabric. *Polymers*, ISSN 2073-4360, Jan. 2022, vol. 14, iss. 3 (571), str. 14, ilustr., doi: 10.3390/polym14030571.
2. DOBNIK-DUBROVSKI, Polona, FAKIN, Darinka, OJSTRŠEK, Alenka. Cotton woven fabrics as protective polymer materials against solar radiation in the range of 210-1200 nm. *Polymers*, ISSN 2073-4360, Mar. 2023, vol. 15, iss. 5, [article no.] 1310, str. 12, doi: 10.3390/polym15051310.
3. DOBNIK-DUBROVSKI, Polona, NOVAK, Nejc, BOROVIŠEK, Matej, VESENJAK, Matej, REN, Zoran. In-plane behaviour of auxetic non-woven fabric based on rotating square unit geometry under tensile load. *Polymers*, ISSN 2073-4360, 2019, vol. 11, iss. 6, str. 1–13, ilustr., doi: 10.3390/polym11061040.
4. KOVAČIČ, Aljaž, NOVAK, Nejc, VESENJAK, Matej, DOBNIK-DUBROVSKI, Polona, REN, Zoran. Geometrical and mechanical properties of polyamide PA 12 bonds in composite advanced pore morphology (APM) foam structures. *Archives of Civil and Mechanical Engineering*, ISSN 1644-9665, Sep. 2018, vol. 18, iss.4, str. 1198–1206, illustr.
5. VAJDA, Jernej, VIHAR, Boštjan, ČINČ ČURIĆ, Laura, MAVER, Uroš, VESENJAK, Matej, DOBNIK-DUBROVSKI, Polona, MILOJEVIĆ, Marko. as post-processing ionic crosslinkers: implications for 3D bioprinting of polysaccharide hydrogels in tissue engineering. *Journal of Materials Research and Technology*, ISSN 2214-0697. [Spletna izd.], March-April 2023, vol. 23, str. 1805–1820, illustr.

## ARIS RESEARCH PROGRAMME P2-0063 Design of Cellular Structures

### NATIONAL AND INTERNATIONAL PROJECTS

- Development of nanotextured yarns, fabrics and films for textile products with thermal and fireproof protection, 01.08.2018 - 30.06.2021.
- Development of High-Performance Piezoelectric Coatings for Self-Charging Nonwovens Applicable in E-Mobility, 1.10.2021 - 30.09.2024.
- Complex in vitro skin model with bone layer included for testing a non-invasive glucose sensor, 1.10.2022 - 30.09.2025.
- Multi-functional woven composite for thermal protective clothing. HRZZ IP-2018-01-3170, 15.11.2018 - 4.11.2022.
- Nanotextured surfaces for membranes, protective textiles, friction pads and abrasive materials, 1.11.2017 - 31.10.2020.

### MEMBERSHIP

- AUTEX - Association of Universities for Textile

6.6 LABORATORY FOR TEXTILE PRINTING AND TEXTILE CARE 

## 6.7 CENTRE FOR TEXTILE CARE



*Head of the Laboratory*

**Assis. Prof. Manja Kurečič**

E-mail: [manja.kurecic@um.si](mailto:manja.kurecic@um.si)

Tel.: +386 2 220 7926

Web: <https://www.fs.um.si/laboratorij-za-tiskanje-tekstilij-in-nego-oblacil/>

The Laboratory for Textile Printing and Textile Care, together with the Centre for Textile Care, is a specialised unit of the Chair for Textile Materials and Design, dedicated to research and development in the fields of textile printing, textile care and hygiene, as well as the development of innovative textile materials. The laboratory brings together advanced research equipment and experts trained to perform various tests, enabling the successful and innovative development of modern fibrous materials. Members of the laboratory are actively involved in numerous projects co-financed by the ministries of the Republic of Slovenia, the European Union, or industrial partners, combining basic and applied research with initiatives to promote technological development. The laboratory also offers professional consulting and implements development projects for industry, enterprises, retail businesses, and other users. This includes establishing partnerships with companies operating in the textile sector. Through such collaborations, the laboratory contributes to the advancement and improvement of textile industry technologies, helping to address specific challenges and problems faced by textile manufacturers and users. In their research and development efforts, laboratory members place special emphasis on studying and addressing the issue of microplastics in textile care. This includes researching the impact of microplastics on the environment and developing alternative materials and processes that reduce microplastic presence in textiles and their release into nature. As an integral part of the Chair for Textile Materials and Design, the laboratory plays a key role in technological advancement and expertise in textile printing, clothing care, and hygiene. Through its research and services, it helps improve textile industry processes and ensures the quality and durability of textile products.

## MAJOR RESEARCH EQUIPMENT

**Nanospider NS 500 Elmarco**

The device enables electrospinning of nanofibres from polymer solution with the help of a strong electrostatic field. This makes it possible to produce nanofibrous structures (nonwoven materials), useful in medicine as wound dressings, or as air filters, etc.

**Inkjet printer Dimatix DMP-2831 Fujifilm**

Fujifilm's Dimatix DMP-2831 printer is used for printing flat materials, with a wide range of commercial and newly developed injection moulding fluids. Variable injection moulding resolution and pattern generation are controlled by Dimatix software.

**Laboratory washing machine FOM 701 CLS Electrolux**

The device is used to determine the washing and disinfecting effects, as well as to evaluate the washing parameters (time, temperature, bath ratio) on physicochemical properties of textile materials and clothing. It enables precise setting and repeatability of Sinner parameters and programming of the washing process (pre-wash/main wash/rinse/final rinsing).



SERVICE OFFER AND SUPPORT TO THE ECONOMY

- Printing on flat textiles and other materials using the Dimatix DMP-2831 Fujifilm laboratory inkjet printer. Analysis of printing fluids and evaluation of print quality.
- Testing in the field of textile care and hygiene, including the evaluation of primary and secondary effects of washing and disinfection, as well as the assessment of damage.
- Development of methods for evaluating micro- and macrofibres in household and industrial washing and drying processes.
- Development of textile care procedures designed for operation in cleanroom conditions.

COOPERATION WITH RESEARCH AND OTHER INSTITUTIONS

- University of Ljubljana, Faculty of Natural Sciences and Engineering, Ljubljana, Slovenia
- Faculty of Chemistry and Chemical Technology, University of Ljubljana, Ljubljana, Slovenia
- Faculty of Electrical Engineering, Computer Science and Informatics, University of Maribor, Maribor, Slovenia
- Faculty of Agriculture and Life Sciences, University of Maribor, Maribor, Slovenia
- Faculty of Mechanical Engineering, University of Ljubljana, Ljubljana, Slovenia
- Josef Stefan Institute, Ljubljana, Slovenia
- Institute of Chemistry, Ljubljana, Slovenia
- Faculty of Polymer Technology, Slovenj Gradec, Slovenia
- Graz University of Technology, Graz, Austria
- Karl Franzens University of Graz, Graz, Austria
- TITK - Thuringian Institute for Textile and Plastics Research, Rudolstadt, Germany
- University of Zagreb, Zagreb, Croatia
- University of Banja Luka, Faculty of Technology, Banja Luka, Bosnia and Herzegovina

COOPERATION WITH COMPANIES

Gorenje, d.o.o., Paloma, d.d., Silchem, d.o.o., Predilnica Litija, d.d., Krka, d.d., Lek, d.d., WFK GmbH, Hanstmann Int. LLC, CHT GmbH, Saponia, d.d., TKI Hrastnik, d.d., Boxmark GmbH, Mercator, d.o.o.

MOST IMPORTANT RESEARCH ACHIEVEMENT

**Development of multifunctional nanofibrous materials using electrospinning technology.** Electrospinning is a method that utilizes electrostatic forces to produce continuous fibres with diameters ranging from a few nanometres to several micrometres.

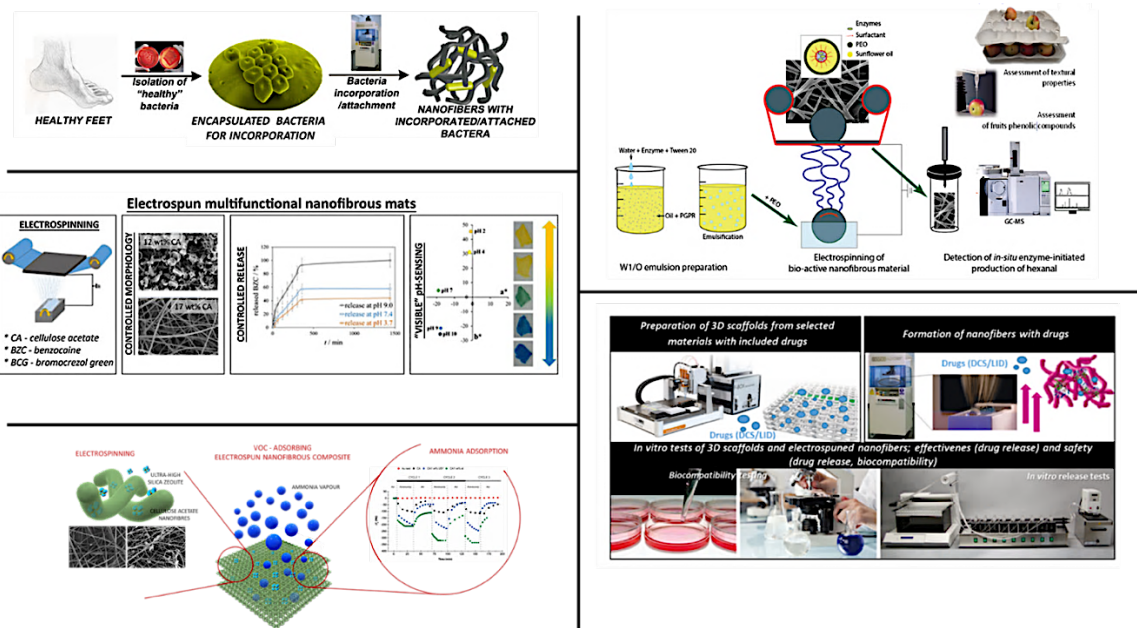

Nanofibres formed through electrospinning have an extremely high active surface area per unit mass (e.g., at a diameter of 100 nm, the fibre surface area is 40 m<sup>2</sup>/g). Additionally, electrospinning enables the controlled design of materials with various functionalities. In our laboratory, we have developed nanofibrous materials with applications in various fields, including: (i) Medical wound dressings with controlled release of active substances, (ii) Materials with prophylactic properties, (iii) Filter materials capable of adsorbing volatile organic compounds (VOCs), (iv) Materials for fruit preservation that facilitate the in-situ formation and release of hexanal, (v) Nanofibrous materials with sensory (halochromic) properties for detecting pH changes in wounds, etc.

#### PUBLICATIONS

1. OJSTRŠEK, Alenka, PETEK, Gabrijela, KOČAR, Drago, KOLAR, Mitja, HRIBERNIK, Silvo, KUREČIČ, Manja. *In-situ enzyme-initiated production of hexanal from sunflower oil and its release from double emulsion electrospun bio-active membranes*. *Food Chemistry*. November 2024, vol. 457, ISSN 1873-7072. DOI: 10.1016/j.foodchem.2024.140032.
2. ELVEREN, Beste, KUREČIČ, Manja, MAVER, Tina, MAVER, Uroš. *Cell electrospinning: a mini review of the critical processing parameters and its use in biomedical applications*. *Advanced Biology*. March 2023, str. 10. ISSN 2701-0198. DOI: 10.1002/adbi.202300057.
3. NERAL, Branko, GORGIEVA, Selestina, KUREČIČ, Manja. *Decontamination efficiency of thermal, photothermal, microwave, and steam treatments for bio contaminated household textiles*. *Molecules*. June 2022, vol. 27, iss. 12 (3667), str. 19, illustr. ISSN 1420-3049. DOI: 10.3390/molecules27123667.
4. ELVEREN, Beste, HRIBERNIK, Silvo, KUREČIČ, Manja. *Fabrication of polysaccharide-based halochromic nanofibers via needle-less electrospinning and their characterization: a study of the leaching effect*. *Polymers*. Oct. 2022, vol. 14, iss. 19 (4239), str. 1–18. ISSN 2073-4360. <https://dk.um.si/IzpisGradiva.php?id=84839>, DOI: 10.3390/polym14194239.
5. OJSTRŠEK, Alenka, FAKIN, Darinka, HRIBERNIK, Silvo, FAKIN, Tomaž, BRAČIČ, Matej, KUREČIČ, Manja. *Electrospun nanofibrous composites from cellulose acetate / ultra-high silica zeolites and their potential for VOC adsorption from air*. *Carbohydrate Polymers*. [Print ed.]. 15 May 2020, vol. 236 (116071), str. 1–11, illustr. ISSN 0144-8617. DOI: 10.1016/j.carbpol.2020.116071.

#### PATENTS AND PATENT APPLICATIONS

- KUREČIČ, Manja, OJSTRŠEK, Alenka, HRIBERNIK, Silvo, VIRANT, Natalija, KOS, Tanja, STANA-KLEINSCHKEK, Karin. Method for the preparation of electrospun pH-indicator cellulose nanofibers: Patent No. SI 25122 A, dated 31.7.2017, Patent application No. P-201600015 dated 13.1.2016. Ljubljana: Intellectual Property Office of the Republic of Slovenia, 2017.
- DOLIŠKA, Aleš, KUREČIČ, Manja, KOS, Tanja, HRIBERNIK, Silvo, PERŠIN FRATNIK, Zdenka, OJSTRŠEK, Alenka, STANA-KLEINSCHKEK, Karin. Preparation for in-vitro controlled release of the active substance: Patent No. SI 24839 A of 3.5.2016, Patent application No. P-201400355 dated 13.10.2014. Ljubljana: Intellectual Property Office of the Republic of Slovenia, 2016.
- KUREČIČ, Manja, DOLIŠKA, Aleš, KOS, Tanja, HRIBERNIK, Silvo, PERŠIN FRATNIK, Zdenka, OJSTRŠEK, Alenka, STANA-KLEINSCHKEK, Karin. Quartz (QCM) crystal carrier for the evaluation of the properties of electrospun nanofibers: Patent No. SI 24666 A dated 30.9.2015, Patent application No. P-201400102 dated 14.3.2014. Ljubljana: Intellectual Property Office of the Republic of Slovenia, 2015.
- KUREČIČ, Manja, SFILIGOJ-SMOLE, Majda, OJSTRŠEK, Alenka, HRIBERNIK, Silvo, STANA-KLEINSCHKEK, Karin. Process for the manufacture of a nanocomposite ultrafiltration membrane with incorporated particles of clay minerals for wastewater treatment: Patent SI24144 dated 31.1.2014. Ljubljana: Intellectual Property Office of the Republic of Slovenia, 2014.
- HRIBERNIK, Silvo, SFILIGOJ-SMOLE, Majda, VERONOVSKI, Nika, KUREČIČ, Manja, STANA-KLEINSCHKEK, Karin, OJSTRŠEK, Alenka. Pretreatment method of regenerated cellulose fibers: Patent No. SI 23971 A of 31.7.2013; Patent Application No. P-201200005 dated 10.1.2012. Ljubljana: Intellectual Property Office of the Republic of Slovenia, 2013.

#### ARIS RESEARCH PROGRAMME P2-0118 Textile Chemistry and Advanced Textile Materials

#### NATIONAL AND INTERNATIONAL PROJECTS

- ARACNE – Advocating the role of silk art and cultural heritage at the national and European scales. HORIZON-CL2-2022-HERITAGE-01-02, 1. 3. 2023–28. 2. 2026.

- BioCel3D – Cellulose from waste and bacteria in electro-spinning for continuous fibre reinforced 3D printed composites. M-Era.Net3, 1. 9. 2022–31. 8. 2025.
- Low-emission household machine drying with evaluation of damage to textile materials. 1. 9. 2021– 31. 8. 2024.
- Development of bioactive nanostructured fibrous membranes for prolonging the quality of fresh fruit. 1. 9. 2020–31. 8. 2023.
- Bioactive, in situ modified, fibrous membranes based on bacterial cellulose: processing, characterisation and evaluation of usefulness in biomedicine. 1. 9. 2020–31. 8. 2023.
- Self-assembling and advanced biopolymer wrappers for microencapsulation of probiotics and starter cultures. 1. 9. 2020–31. 8. 2023.
- Renewable materials and healthy environments Research and Innovation Centre of Excellence. Innorenew CoE: H2020-SGA-CSA, 2017–2023.
- Initial stages of surface functionalisation of polymers by plasma radicals. 1. 7. 2019–30. 6. 2022.
- A new innovative approach to the treatment of diaper rash using diapers with embedded probiotic bacteria. 1. 7. 2019–30. 6. 2022.
- Metallisation of textiles to make urban living for older people more independent and fashionable. MATUROLIFE: H2020, 2018–2021.
- Cultivation of industrial hemp (*Cannabis sativa* L.) in Slovenia. 2016–2019.
- Electrostatic immobilisation of bacteria and the impact on their physiology. 2016–2019.
- Advanced haemocompatible surfaces of vascular splints. 2016–2019.

#### INTERNATIONAL MEMBERSHIPS

- EPNOE - European Network of Excellence for polysaccharide
- POLIMAT - Centre of Excellence Polymer Materials and Technologies
- AUTEX - Association of Universities for Textile
- EURATEX - European Technology Platform for the Future of Textiles and Clothing
- FESPA - Federation of European Screen Printers Associations
- ICTC - International Technical Committee for Textile Care

#### 6.8 CENTRE FOR DYEING AND COLOR



*Head of the Centre*

**Assoc. Prof. Alenka Ojstršek**

*E-mail: [alenka.ojstrsek@um.si](mailto:alenka.ojstrsek@um.si)*

*Tel.: +386 2 220 7637*

*Web: <https://www.fs.um.si/laboratorij-za-barvanje-barvno-metrika-in-ekologijo-plemenitenja/center-za-barvanje-in-barvo/>*

The Centre for Dyeing and Colour performs a wide range of activities related to colour perception and colour measurement in various industries, such as textiles, the paper industry, architecture, art, psychology, the food industry, medicine, heritage science, and other related industries.

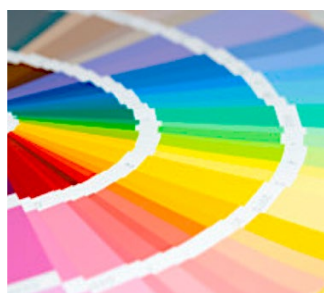

*Colour samples and spectrophotometer for measurement in the U-VIS-NIR domain.*

Its activities include measurements of reflective values of coloured samples, determination of colour metric values and colour differences, whiteness measurements, measurements in the field of U-VIS-NIR, determination of the protective factor of samples against UV radiation, development of ecologically acceptable staining processes, education, consulting, studies and opinions. The centre also has a variety of spectrophotometers, systematised colour maps, systems and catalogues. The activities are key to ensuring the quality, safety and sustainability of paint materials and processes in many industries.

## 6.9 RESEARCH AND INNOVATION CENTRE FOR DESIGN AND CLOTHING SCIENCE



Head of the Centre

**Prof. Jelka Geršak**

E-mail: [jelka.gersak@um.si](mailto:jelka.gersak@um.si)

Tel: +386 2 220 7960

Web: <https://ricdoi.fs.um.si/>

The Research and Innovation Centre for Design and Clothing Science RICDCS was founded in 2015 with the aim of implementing, effectively developing, organising and promoting educational and scientific research in the fields of innovative design, clothing science and the development of functional and intelligent clothing. Its research activities are carried out within the framework of the research programme *Clothing Science, Comfort and Textile Materials* and national and international scientific research projects. A significant part of the research activities focuses on the narrower field of clothing engineering, experimental design, the development of clothing for people with limited mobility, innovative technologies in the field of intelligent clothing development, clothing physiology and wearing comfort, and clothing heritage science.

The Laboratory for Clothing Engineering, Physiology and Garment Construction and the Fashion Studio operate within the framework of RICDCS. The laboratory is equipped with the appropriate modern equipment and research infrastructure, which enables high quality implementation of both scientific research and educational activities in a broader field of activity. An important part of the research infrastructure is a computer-controlled climate chamber for research on thermal comfort when wearing clothing with appropriate equipment for measuring thermal physiological parameters – bio signals of test subjects.



*Interweaving science and design: The Innovative projects of the RICDCS:*

- a. From the workshop *Zero waste design Inspired by cultural heritage*, Design Week 2022
- b. Technical sketch from the workshop *Electrical conductors in the world of intelligent clothing - the road to robustness*, Design Week 2023,
- c. *Experimental Clothing* by student Christian Herzog in the Clothing Design course, 2023
- d. The final product of the workshop *Photography as a memory and material record – Memory Quilt*, Design Week 2023
- e. *Inspiring mood board* of student Kristina Korenjak, 2024
- f. Study of the thermal physiological stresses on the test subject (mobile recording of bio signals) when wearing a functional T-shirt under a modified medical corset
- g. The development of smart clothing to improve the safety of people with dementia



MAJOR RESEARCH EQUIPMENT

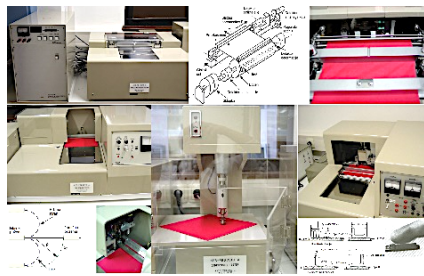

**KES-FB AUTO measuring system, Katō Tech Co., Ltd., Japan**

It is used for objective evaluation of the mechanical behaviour of flat textiles (fabrics, knitted fabrics, nonwovens, laminates) at low loads and surface properties, and enables the analysis of complete reversible deformations caused by small tensile, shear, bending and compression stresses. The system also enables the measurement of the mechanical behaviour of non-textile materials such as leather, paper, membranes, foils and other flexible flat materials.

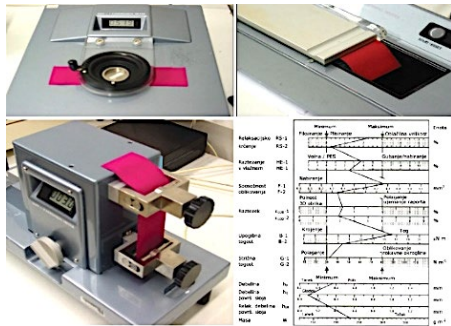

**FAST measuring system, CSIRO Division of Wool Technology, Australia**

The measuring system is used to control the mechanical properties in the manufacture of fabrics, in finishing and in the control of clothing production processes. It is based on the technology of the objective evaluation of mechanical properties at lower loads and dimensional stability as physical property. The results are based on 14 parameters (compression, bending, tensile and shear properties, formability and dimensional stability) and a FAST control chart that indicates potential problems in the clothing manufacturing process.



**KES-FB7 - ThermoLabo II, Katō Tech Co., Ltd., Japan**

ThermoLabo is a measurement system for determining the thermal properties of flat textiles and other flat materials as important parameters of biophysical analysis of clothing systems. It is a system that simulates the transfer of heat and/or water vapour through flat textiles or other materials, and is used to determine thermal conductivity  $\lambda$ , thermal resistance  $R_{ct}$  and water vapour resistance  $R_{et}$ , water vapour permeability index  $imt$ , heat retention coefficient and warm-cold feeling  $q_{max}$  when the fabric is in contact with the skin.

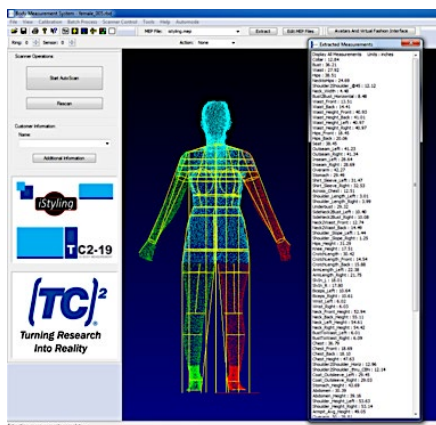

**TC<sup>2</sup>- 19M 3D body scanner, TC2 Labs LLC., North Carolina**

It is a system for scanning the human body. It enables the contactless, fully automated scanning of the human body and the creation of a virtual human body, a so-called avatar. The system records around 1,000 different measurements and enables body shape, body mass, characteristic indices, body volume and other anthropometric data to be analysed. It is used for the standardised recording of body measurements and forms the basis for: the determination of the anthropometric measurements of the population and the creation of virtual parametric bodies, so-called avatars, which form the basis for the development of virtual clothing, as well as their simulation in the area of collection development and the virtual reconstruction of cultural clothing heritage.

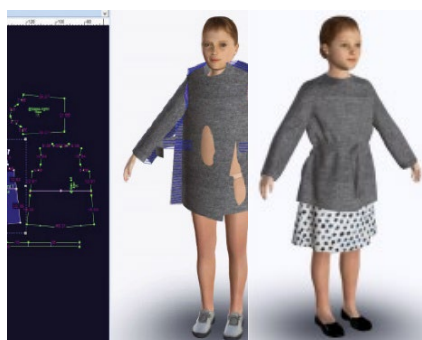

**OptiTex PDS, Optitex Ltd., Israel**

OptiTex PDS is a CAD garment pattern design software which, with the support of a 3D module, enables the simulation of clothing in a virtual environment and their fitting on virtual 3D body models created based on data acquired with the TC<sup>2</sup>-19M 3D body scanner. The software enables the use of the so-called Fabric Editor, which converts the parameters of the mechanical and physical properties of the fabrics measured with the KES-FB or FAST measuring systems into a form suitable for 3D simulation of textile draping, and the simulation of 3D clothing prototypes in a virtual environment.

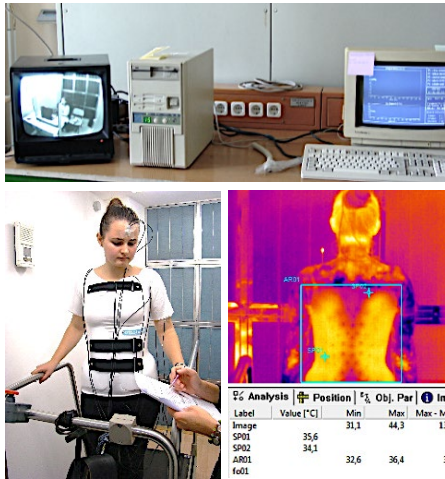

### Computer-controlled climate chamber, IZR, d.o.o., Škofja Loka, Slovenia

The climate chamber with a cooling and heating unit and video monitoring system is intended for studying the thermophysiological stress of test subjects under various thermal environmental loads or for the studying the physiological responses of the human body during various activities: during movement (casual clothing, summer clothing, business clothing, sports clothing), during sleep (mattresses, sleeping bags), while driving (car seat covers), and/or at work (work and protective clothing) and under various environmental conditions. From a research point of view, it is an important part of the infrastructure that makes it possible to evaluate the effects of the thermal environment on the user's thermal well-being when wearing individual clothing systems under certain artificially created climatic conditions that simulate the real environment.

### SERVICE OFFER AND SUPPORT TO THE ECONOMY

- Analysis of the quality parameters of textiles and clothing: Analysis of the parameters of mechanical and physical properties of flat flexible materials (flat textiles, leather, paper, foils, etc.), determined by the KES-FB and FAST measuring system, determination of thermal properties of flat textiles (thermal resistance  $R_{ct}$ , water vapour resistance  $R_{et}$ , thermal conductivity  $\lambda$ ).
- Determination of the parameters of thermophysiological comfort when wearing clothing (evaluation of thermal stress using physiological measurements) under different various climatic conditions.
- Construction of basic pattern and modelling of clothing pattern-pieces, grading of pattern-pieces, virtual prototyping of clothing.
- Conventional analysis and testing of textile materials (threads, woven and knitted fabrics, clothing) according with the standards.
- We also carry out the design of textiles and clothing and provide expertises on the causes of problems in the clothing manufacturing process, and visual assessment of the quality of the clothing produced, etc.

### COOPERATION WITH RESEARCH AND OTHER INSTITUTIONS

- Heriot-Watt University, Edinburgh, United Kingdom
- Nottingham Trent University, Nottingham, United Kingdom
- Technical University of Dresden - Institute of Textile Machinery and High-Performance Material Technology, Dresden, Germany
- Academy of Fine Arts and Design in Bratislava, Bratislava, Slovakia
- University of Zagreb, Faculty of Textile Technology, Zagreb, Croatia
- University of Hradec Králové, Faculty of Education, Hradec Králové, Czech Republic
- Lodz University of Technology, **Faculty of Material Technologies and Textile Design**, Lodz, Poland
- Technical University of Liberec, Faculty of Textile Engineering, Liberec, Czech Republic
- University of Arts in Belgrade, Faculty of Applied Arts, Beograd, Belgrade, Serbia
- University of Novi Sad, Technical Faculty "Mihajlo Pupin" Zrenjanin, Zrenjanin, Serbia
- University of Sarajevo, Academy of Fine Arts, Sarajevo, Bosnia and Herzegovina
- University of Bihać, Technical faculty, Bihać, Bosnia and Herzegovina
- University of Banja Luka, Faculty of Technology, Banja Luka, Bosnia and Herzegovina
- University of Niš, Faculty of Technology in Leskovac, Leskovec, Serbia
- Óbuda University, Rejtő Sándor Faculty of Light Industry and Environmental Engineering, Budapest, Hungary
- Vilnius Academy of Arts, Vilna, Lithuania
- National Institute for Research and Development for Textiles and Leathers (INCDTP), Romania

- Ghent University, Ghent, Belgium
- University College Ghent (HOGENT), Ghent, Belgium
- Ecole Nationale Supérieure Arts Industries Textiles (ENSAIT), France
- TecMinho, Interface of the University of Minho, Guimaraes, Portugal
- Technological Centre of the Textile and Clothing Industries of Portugal, Portugal
- Gheorghe Asachi Technical University of Iasi, Iasi, Romania
- University of Ljubljana, Faculty of Science, Ljubljana, Slovenia
- University of Ljubljana, Faculty of Medicine, Ljubljana, Slovenia
- Ecole Nationale Supérieure Arts Industries Textiles (ENSAIT), France
- TecMinho, Interface of the University of Minho, Guimaraes, Portugal
- Technological Centre of the Textile and Clothing Industries of Portugal, Portugal
- Gheorghe Asachi Technical University of Iasi, Iasi, Romania
- Faculty of Science, University of Ljubljana, Ljubljana, Slovenia
- Faculty of Medicine, University of Ljubljana, Ljubljana, Slovenia

### COOPERATION WITH COMPANIES

Lisca, d.o.o., Sevnica; Prevent&Deloza, d.o.o., Celje; Mavisa, d.o.o., Trzin; International Institute for Consumer Research, Ljubljana; Association of Paraplegics of Slovenia, Association of Paraplegics of Podravje, Regional Museum Maribor, Regional Museum Ptuj - Ormož and others.

### MOST IMPORTANT RESEARCH ACHIEVEMENT

The scientific monograph **Design of Clothing Manufacturing Processes - A Systematic Approach to Developing, Planning, and Control** deals systematically and comprehensively with the design of traditional and advanced clothing manufacturing processes, from basic theory and definitions to the rules in mathematical form.

## Design of Clothing Manufacturing Processes

A Systematic Approach to Developing, Planning, and Control

Second Edition



Jelka Geršak



THE TEXTILE INSTITUTE BOOK SERIES



The content, systematically organised over 375 pages and enriched with its own theoretical and practical knowledge and experience, provides a critical assessment of technological development and scientific understanding in areas related to the design of conventional and advanced clothing manufacturing processes, from theory and definitions to technical standards in response to the search for new approaches related to new applications, sustainable fashion, knowledge of the drivers of success in the development of a new product and the digital transformation that requires new marketing models and tools in fashion e-commerce. This new edition is updated with important new research findings and topics, including digital fashion, which covers scientific aspects of fabric modelling, simulation and digital fitting of clothing, and the performance of seams as an important criterion for the quality and appearance of clothing. The content, which is divided into nine chapters, provides a foundation for researchers who want to accelerate the development of new methods and techniques and create new scenarios for the future.

### PUBLICATIONS

1. GERŠAK, J. *Design of clothing manufacturing processes: a systematic approach to developing, planning, and control*. 2nd ed. Oxford: Woodhead Publishing: Elsevier, cop. 2022. XIII, str. 375, *The Textile Institute book series*. ISBN 978-0-08-102648-9, ISBN 978-0-08-102772-1.
2. SLEMENŠEK, J., FISTER, I., GERŠAK, J., BRATINA, B., VAN MIDDEN, V. M., PIRTOŠEK, Z., ŠAFARIČ, R. *Human gait activity recognition machine learning methods*. *Sensors*. 2023, vol. 23, iss. 2, 745, str. 1–24. ISSN 1424-8220. DOI: 10.3390/s23020745.
3. RUDOLF, A., ŠTERMAN, S., CUPAR, A. *Development of a textile sheet mask design for facial care based on a 3D face model of an average woman*. *Journal of Engineered Fibers and Fabrics*. April 2024, vol. 19, str. 14. ISSN 1558-9250. DOI: 10.1177/15589250241254443.

4. BOBOVČAN MARCELIČ, M., GERŠAK, J., ROGALE, D., FIRŠT ROGALE, S. *Study of the compression properties of welded seams formed using hot wedge, hot air, ultrasonic, and high-frequency welding techniques. Textile Research Journal. 2022; 92(23-24), str. 4736–4752. ISSN 0040-5175. DOI: 10.1177/00405175221109637.*
5. STOJANOVIĆ, S., GERŠAK, J., URAN, S. *Development of the Smart T-Shirt for Monitoring Thermal Status of Athletes. AUTEX Research Journal, vol. 23, no. 2, 2023, str. 266–278. <https://doi.org/10.2478/aut-2022-0005>.*

#### PATENTS AND PATENT APPLICATIONS

- GERŠAK, J. Measuring System for Programmed Measurement and Evaluation of Mechanical Properties of Linear and Flat Flexible Materials: Patent No. SI 23645 A, Date of Publication 31.8.2012; Patent Application No. P-201200162, date of filing of the application 24.5.2012. Ljubljana: Ministry of Economic Development and Technology, Intellectual Property Office of the Republic of Slovenia, 2012.
- GERŠAK, J. Intelligent Functional Jacket for the Injury Detection with Partial Puncture Protection Function: Patent Grant Decision: Patent No. 22644, 30.4.2009; application number P-200800294 dated 01.12.2008. Ljubljana: Intellectual Property Office of the Republic of Slovenia, 2009

#### ARIS RESEARCH PROGRAMME P2-0123 Clothing Science, Comfort and Textile Materials

#### NATIONAL AND INTERNATIONAL PROJECTS

- ARACNE - Advocating the Role of silk Art and Cultural heritage at the National and European scales. HORIZON-CL2-2022-HERITAGE-01, 1.3.2023 - 28.2.2026.
- DigitalFashion - Collaborative Online International Learning in Digital Fashion. Erasmus + KA220-HED, 1.2.2022 - 31.1.2025.
- Big going Small. Erasmus+ KA210-VET3E10A3FF, 1.1.2024 - 31.12.2025.
- Erasmus+ KA210-VET3E10A3FF: Big going Small; 1.1.2024 - 31.12.2025.
- Erasmus+ KA203-079823: Software tools for textile creatives; 1.12.2020 - 30.11.2022.
- CEEPUS network SI-0217 Ars-Techne: Creative Design and Innovation.

**CEEPUS NETWORK SI-0217 ARS-TECHNE: CREATIVE DESIGN AND INNOVATION** is the first network at the Faculty of Mechanical Engineering at the University of Maribor, founded in 1997 as the Slovenian network CEEPUS SI-0007. It is the first network that connected faculties in the field of textile and clothing engineering and promotes the mobility of students and professors between the participating countries. The network has been operating successfully since 1997, when four universities joined the network as part of the programme *Modelling of Credits Transfer System in Textile Higher Education*. Today, the network comprises 14 partner institutions and is often presented as an example of good practice. The established network has played an important role in the field of textile education, as it was the first to open the door to an active Central European network of partner institutions and has led to active multilateral cooperation through its activities, which is also reflected in the successfully organised international CEEPUS Winter Schools Design Week, which has further strengthened this cooperation. In 2018, the SI-0217 Ars-Techne: Creative Design and Innovation network received the Apple of Quality 2018, a national award from the Ministry of Education, Science and Sport, and CMEPIUS, that annually rewards the most outstanding stories of international cooperation, while in 2019, the coordinator of network received the Ministers' Prize of Excellence 2019 for outstanding achievements. In 2024, the network coordinator received the Diploma for his outstanding work in the Slovenian network Ars-Techne: Creative Design and Innovation.

**INTERNATIONAL CEEPUS WINTER SCHOOL DESIGN WEEK** is a visible and recognisable activity of the network. The beginnings of the international CEEPUS Winter School Design Week date back to 2012, when the concept of the Winter School was designed, which covers the spectrum of modern engineering design of clothing and/or other textile forms in the broadest sense of connecting scientific and artistic disciplines. The motto of these is human-centric design and innovation:

- Design as a driver of people-centred innovation, 2<sup>nd</sup> international CEEPUS Winter School Design Week 2013, Maribor, 20-26 October 2013.
- New challenges for the innovative solutions, 3<sup>rd</sup> international CEEPUS Winter School Design Week 2014, Maribor, 19-25 October 2014.



- New challenges - new ideas - new solutions, 4<sup>th</sup> international CEEPUS Winter School Design Week 2015, Maribor, 18-24 October 2015.
- Design in the light of light - new challenges – new solutions, 5<sup>th</sup> international CEEPUS Winter School Design Week 2016, Maribor, 16-22 October 2016.
- Design & Transdisciplinarity - New Challenges, 6<sup>th</sup> International CEEPUS Winter School Design Week 2017, 15-21 October 2017.
- Smart Design, Science & Technology - New Challenges, 7<sup>th</sup> International CEEPUS Winter School Design Week 2022, Maribor, 16-22 October 2022.
- Transdisciplinary: Design, Science & Technology - the basis for the development of people- and environmentally friendly solutions, 8<sup>th</sup> international CEEPUS Winter School Week 2023, Maribor, 15-21 October 2023.
- Transdisciplinary: Design, Science & Technology - the basis for the development of people- and environmentally friendly solutions, 9<sup>th</sup> international CEEPUS Winter School Design Week 2024, Maribor, 20-26 October 2024.



#### MEMBERSHIPS

- AUTEX - Association of Universities for Textile
- Textile ETP - European Technology Platform for the Future of Textiles and Clothing
- PPE for Pesticide - International Consortium for the Development and Evaluation of PPE for Pesticide Operators and Re-entry Workers
- IPC E-Textiles Committee Europe Working Groups for E-Textiles Standards
- HATZ - Croatian Academy of Engineering

## 7. FUNDAMENTAL AND GENERAL SUBJECTS

In the field of Fundamental and General Subjects, there are 2 laboratories:

LABORATORY:	HEAD:
7.1 Laboratory for Physics	Robert Hauko
7.2 Laboratory for Mathematics	Irena Kosi-Ulbl



*Head of the Chair of Fundamental and General Subjects*

**Assis. Prof. Irena Kosi Ulbl**

E-mail: [irena.kosi@um.si](mailto:irena.kosi@um.si)

Tel: +386 2 220 7830

Web: <https://www.fs.um.si/katedra-za-temeljine-in-splosne-predmete/>

### 7.1 LABORATORY FOR PHYSICS



*Head of the Laboratory*

**Assis. Prof. Robert Hauko**

E-mail: [robert.hauko@um.si](mailto:robert.hauko@um.si)

Tel: +386 2 220 7823

Web: <https://www.fs.um.si/katedra-za-temeljine-in-splosne-predmete/raziskovalna-dejavnost/laboratorij-za-fiziko/>

The main task of the Laboratory for Physics is to teach physics at the Faculty of Mechanical Engineering. In addition, the members of the laboratory are active in research in the fields of atomic physics, biophysics and soft matter physics, and didactics of physics.

In atomic physics, using X-ray absorption and fluorescence methods, we study multi-electron photoexcitations in an atom and analyse the close neighbourhood of the atom. Most of the research work is done at synchrotrons in Hamburg, Grenoble and Trieste. The EXAFS and XANES measurement techniques enable the precise determination of the valence and atomic environment of the selected element, the work is done in collaboration with research groups in the field of materials and chemistry. The research in biophysics focuses on biologically important molecules, specifically, guanosine and short, guanine-rich DNA sequences. The self-assembly of these molecules in solutions is studied by light scattering and UV-VIS spectrometry, and their organisation on solid surfaces by an atomic force microscope. In soft matter physics, liquid crystalline phases formed by condensed solutions of short, guanine-rich DNA sequences are studied using optical polarisation microscopy. Experimental work in soft matter physics and biophysics is carried out in cooperation with the Jožef Stefan Institute in Ljubljana. In the field of didactics, together with students, we explore new thematic and methodological approaches to teaching physical problems.

#### SERVICE OFFER AND SUPPORT TO THE ECONOMY

- Collaboration in the application, preparation and implementation of synchrotron measurements in the field of Materials and Chemistry, X-ray absorption and fluorescence: Elettra synchrotron (XAFS beamline) and DESY Petra III (beamlines P65 and P64)
- Analysis of synchrotron measurements

#### COOPERATION WITH RESEARCH AND OTHER INSTITUTIONS

- Jožef Stefan Institute, Ljubljana, Slovenia
- National Institute of Chemistry, Ljubljana, Slovenia
- University of Ljubljana, Ljubljana, Slovenia
- University of Nova Gorica, Nova Gorica, Slovenia
- Deutsches Elektronen-Synchrotron DESY, PETRA III, Hamburg, Germany
- Elettra Sincrotrone Trieste, Trieste, Italy

- European Synchrotron Radiation Facility ESRF, Grenoble, France
- Polytechnic University of Marche, Ancona, Italy

### MOST IMPORTANT RESEARCH ACHIEVEMENT

When developing **materials for different bionanoapplications** we can take advantage of DNA self-assembly mechanisms, e.g., the fact that guanine-rich DNA sections are organised into nanowires. Cooperation with researchers from the Faculty of Chemistry and Chemical Technology and the Faculty of Mathematics and Physics of the University of Ljubljana, researchers from the Institute of Chemistry and the Jožef Stefan Institute enables us to gain an in-depth understanding of the internal structure and mechanism of the formation of such nanowires. The results of the joint work were published in the journal Nature Communications as a research paper titled Understanding self-assembly at molecular level enables controlled design of DNA G-wires of different properties.

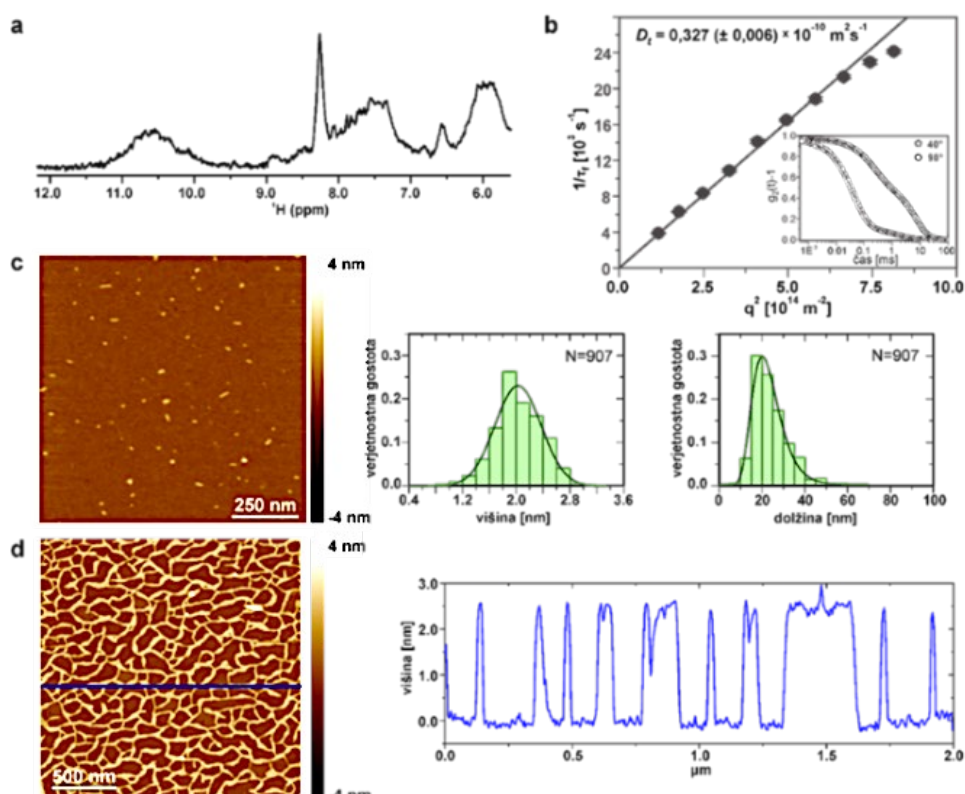

The formation of guanine-rich DNA sequences is studied using nuclear magnetic resonance (NMR) techniques (a) Light scattering (b) AFM (c) and (d). Source: <https://www.nature.com/articles/s41467-022-28726-6>

Cooperation with researchers from the Faculty of Chemistry and Chemical Technology and the Faculty of Mathematics and Physics of the University of Ljubljana, researchers from the Institute of Chemistry and the Jožef Stefan Institute enables us to gain an in-depth understanding of the internal structure and mechanism of the formation of such nanowires. The results of the joint work were published in the journal Nature Communications in the form of a research paper titled Understanding DNA Self-Assembly at the Molecular Level Enables Controlled Design of G-Strings of Different Traits.

### PUBLICATIONS

1. HAUKO, Robert, PADEŽNIK GOMILŠEK, Jana, KODRE, Alojz, ARČON, Iztok, LUIN, Uroš. Iodine K- and L-edge X-ray absorption spectra of HI: the effect of molecular orbitals and core subshells. *Radiation physics and chemistry*. 2024, vol. 229, [article no.] 112509, str. 1-8, DOI: 10.1016/j.radphyschem.2025.112509.
2. PAVC, Daša, SEBASTIÁN UGARTECHE, Nerea, SPINDLER, Lea, DREVENŠEK OLENIK, Irena, KODERMAN POBDOŠEK, Gorazd, PLAVEC, Janez, ŠKET, Primož. Understanding self-assembly at molecular level enables controlled design of DNA G-wires of different properties. *Nature Communications*. Feb. 2022, vol. 13, str. 11, DOI: 10.1038/s41467-022-28726-6.

3. POTRČ, Melani, SEBASTIÁN UGARTECHE, Nerea, ŠKARABOT, Miha, DREVENŠEK OLENIK, Irena, SPINDLER, Lea. *Supramolecular polymorphism of (G4C2)<sub>n</sub> repeats associated with ALS and FTD. International Journal of Molecular Sciences.* Apr. 2021, vol. 22, art. no. 4532, str. 12, DOI: 10.3390/ijms22094532.
4. HAUKO, Robert, PADEŽNIK GOMILŠEK, Jana, KODRE, Alojz, ARČON, Iztok. *X-ray absorption spectroscopy set-up for unstable gases: a study of 5p hydrides. Radiation Physics and Chemistry.* Jun. 2020, vol. 171, str. 1–4. <https://repozitorij.ung.si/lzpisGradiva.php?id=5021>, DOI: 10.1016/j.radphyschem.2020.108743.
5. PAVC, Daša, WANG, Baifan, SPINDLER, Lea, DREVENŠEK OLENIK, Irena, PLAVEC, Janez, ŠKET, Primož. *GC ends control topology of DNA G-quadruplexes and their cation-dependent assembly. Nucleic Acids Research.* 2020, vol. 48, iss. 5, str. 2749–2761, DOI: 10.1093/nar/gkaa058.

#### ARIS RESEARCH PROGRAMMES

P1-0112 Research of Atoms, Molecules and Structures with Photons and Particles (JSI)

P1-0192 Light and Matter (JSI)

#### MEMBERSHIPS

- DMFA - Society of Mathematicians and Physicists of Slovenia

#### 7.2 LABORATORY FOR MATHEMATICS



*Head of the Laboratory*

**Assis. Prof. Irena Kosi Ulbl**

E-mail: [irena.kosi@um.si](mailto:irena.kosi@um.si)

Tel: +386 2 220 7830

Web: <https://www.fs.um.si/katedra-za-temeljne-in-splosne-predmete/raziskovalna-dejavnost/laboratorij-za-matematiko/>

The Laboratory for Mathematics at the Faculty of Mechanical Engineering focuses on teaching and researching mathematical areas, especially graph theory and non-commutative rings theory. In graph theory, which has a wide range of applications in physics, chemistry, biology and other sciences, we study the modelling of relationships and processes. We study different graph invariants, such as the chromatic number, the domination number, connectivity and hamiltonicity of graphs. These invariants are studied for various classes of graphs, such as planar graphs or graph products. In the second part of the research work, we examine identities with additive mappings, which turn out to be derivations, Jordan \*-derivations, or centralizers under certain conditions for rings. We also deal with solving functional equations on operator algebras, where the operators act on Banach or Hilbert spaces.

#### COOPERATION WITH RESEARCH AND OTHER INSTITUTIONS

- University of Ljubljana, Ljubljana, Slovenia
- Institute of Mathematics, Physics and Mechanics, Ljubljana, Slovenia
- University of Kragujevac, Kragujevac, Serbia
- University of Montenegro, Podgorica, Montenegro
- Vanderbilt University, Nashville, USA

#### MOST IMPORTANT RESEARCH ACHIEVEMENT

We investigate **plane triangulations and their properties**. We are particularly interested in the domination number of planar triangulations, for which the well-known Matheson-Tarjan conjecture asserts that any planar triangulation on  $n$ -vertices has a dominating set of size not more than  $n/4$ . We introduce a class of planar graphs called weak near-triangulations. It turns out that the class of weak near-triangulations is closed under certain graph operations, and, by means of these operations, we proved that each weak near-triangulation has a dominating set of size at most  $17n/53$ .



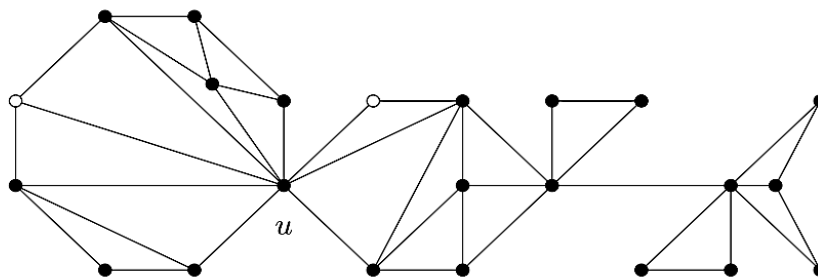

The paper was published in the *Journal of Combinatorial Theory Series B*.

## PUBLICATIONS

1. PAJ ERKER, Tjaša, ŠPACAPAN, Simon. Separation of Cartesian products of graphs into several connected components by the removal of vertices. *Discussiones mathematicae. Graph theory*, 2022, vol. 42, no. 3, str. 905–920, DOI: 10.7151/dmgt.2315.
2. KOSI-ULBL, Irena, VUKMAN, Joso. On a functional equation related to generalized inner derivations. *Publicationes mathematicae. [Print ed.]*. 2022, vol. 100, no. 3/4, str. 427–434, DOI: 10.5486/PMD.2022.9170.
3. KOSI-ULBL, Irena, RODRÍGUEZ PALACIOS, Angel, VUKMAN, Joso. A generalization of a theorem of Chernoff on standard operator algebras. *Monatshefte für Mathematik. [Print ed.]*. June 2021, vol. 195, str. 675–685, DOI: 10.1007/s00605-021-01596-8.
4. ŠPACAPAN, Simon. Separation of Cartesian products of graphs into several connected components by the removal of edges. *Applicable Analysis and Discrete Mathematics*. 2021, vol. 15, iss. 2, 357–377, DOI: 10.2298/AADM160719018S.
5. ŠPACAPAN, Simon. A counterexample to prism-hamiltonicity of 3-connected planar graphs. *Journal of Combinatorial Theory. Series B*. Jan. 2021, vol. 146, str. 364–371, DOI: 10.1016/j.jctb.2020.09.012.

## ARIS RESEARCH PROGRAMME P1-0297 Graph Theory

### NATIONAL AND INTERNATIONAL PROJECTS

- Chvatal's conjecture and related problems. Bilateral project SLO-USA, 01.07.2022 - 30.06.2024.
- Hamiltonianism and perfect modifications in graph products. Bilateral project SLO-CRG, 1.1.2023 - 31.12.2024.
- Topological indices of graphs and digraphs. Bilateral project SLO-SRB, 01.07.2023 - 30.06.2025.

### MEMBERSHIPS

- Society of Mathematicians, Physicists and Astronomers of Slovenia

# FACULTY OF MECHANICAL ENGINEERING: RESEARCH GUIDE

LIDIJA FRAS ZEMLJIČ, TATJANA KREŽE, MATEJA NOVAK (EDS.)

University of Maribor, Faculty of Mechanical Engineering, Maribor, Slovenia  
lidija.fras@um.si, tatjana.kreze@um.si, mateja.novak@um.si

The publication presents an overview of research activities and research achievements at the Faculty of Mechanical Engineering. The following research areas are presented: Energy, process and environmental engineering, Construction and design, Materials technology, Mechanics, Production engineering, Textile materials and design, and Fundamental and general areas. Individual laboratories and centers of the faculty present their research equipment, service offerings for industry, collaborations with companies and other institutions, the most prominent publications, patents, national and international projects and the most important research achievements.

DOI  
[https://doi.org/  
10.18690/um.fs.2.2025](https://doi.org/10.18690/um.fs.2.2025)

ISBN  
978-961-286-964-9

**Keywords:**  
energy,  
process and environmental  
engineering,  
construction and design, materials  
technology, mechanics,  
production engineering, textile  
materials and design



University of Maribor Press



University of Maribor

---

Faculty of Mechanical Engineering



**FACULTY OF MECHANICAL ENGINEERING**  
Smetanova ulica 17, 2000 Maribor, Slovenia  
*<https://www.fs.um.si/>*